

100 SERIES
WINDOWS • DOORS



**THE SMART
ALTERNATIVE TO VINYL**

CONTENTS

100 SERIES WINDOWS & PATIO DOORS

Performance	2
Fibrex® Material	4
Frame Types	6
Window & Door Types	8
Color Options	10
Hardware Options	11
Glass Options	12
Grille & Insect Screen Options	13
Window Combinations	14
<hr/>	
Windows	15
Casement Windows	18
Awning Windows	25
Single-Hung Windows	30
Gliding Windows	52
Picture, Transom & Specialty Windows	66
<hr/>	
Patio Doors	91
Gliding Patio Doors	93
Patio Door Sidelights & Transoms	94
<hr/>	
Combination Designs	99
Product Performance	102
Installation	108
Sustainability	111



The MOST RECOGNIZED, TRUSTED and RECOMMENDED brand of windows and patio doors.*



Hanley Wood Builder Brand Use Study
1998-2019
Windows – Wood & Clad-Wood Category



Hanley Wood Remodeling Brand Use Study
2006, 2010, 2013, 2015, 2017
Windows – Wood & Clad-Wood Category



Awarded Most Environmentally Friendly
Windows 7 years running
2011-2018



Andersen Corporation, including its subsidiaries, has been named a 2019 ENERGY STAR Partner of the Year – Sustained Excellence Award winner, the highest honor given by ENERGY STAR, for continued leadership in protecting the environment through superior energy efficiency achievements.

For warranty information,
visit andersenwindows.com/warranty.

* 2018 U.S. Homeowner Brand Study of Andersen and Renewal by Andersen brands vs. competitive brands.
“ENERGY STAR” is a registered trademark of the U.S. Environmental Protection Agency.



For over a century, Andersen has been helping families make their homes brighter, more comfortable and more beautiful. We do it by making windows and patio doors that are different and better than any others. Our commitment to constant innovation as well as rigorous testing means that you can count on Andersen to deliver unsurpassed quality and reliability, in addition to exceptional service and support.

100 SERIES PRODUCTS THE SMART ALTERNATIVE TO VINYL

Whether you're replacing, remodeling or building, Andersen® 100 Series windows and patio doors are a smart step-up from vinyl. They provide uncommon value, combining time-tested performance with long-lasting beauty. Made with our innovative Fibrex® composite material, which comes in deep, rich colors, and is environmentally responsible and energy efficient, 100 Series products are a winning choice for anyone considering vinyl windows and doors.



Fibrex material retains its stability and rigidity in all climates, delivering exceptional durability. It makes our 100 Series products rigid and strong, so the weathertight seals stay weathertight.



The finish on 100 Series products has superior scratch resistance compared to painted vinyl windows,* so they'll look beautiful for years to come.



100 Series products can withstand temperatures up to 150°F, even in dark colors, meaning they won't warp due to sun exposure.

* When 100 Series products were tested against five leading competitors' painted vinyl window products.

100 SERIES WINDOWS & DOORS

DELIVER BEAUTY, PERFORMANCE & DURABILITY.

ATTRACTIVE CORNER SEAMS.

100 Series products feature **low-visibility corner seams** for a cleaner and more contemporary look.

COLORS THAT LAST.

Durable, factory-finished interiors and exteriors never need painting and **won't fade, flake, blister or peel,** even in extreme cold or heat.

ATTRACTIVE MATTE INTERIORS.

Premium matte finish isn't shiny like vinyl and is available in white, Sandtone, dark bronze and black.**

ENERGY EFFICIENT IN EVERY CLIMATE.

Energy-efficient 100 Series products are available with options that make them ENERGY STAR® certified throughout the U.S., so they can help reduce heating and cooling bills. What's more, Fibrex® composite material **blocks thermal transfer nearly 700 times better** than aluminum.



EASY OPERATION FOR YEARS TO COME.

All 100 Series products are **tested to the extreme** to deliver years* of smooth, reliable operation.

SUPERIOR WEATHER RESISTANCE.

Our weather-resistant construction **seals out drafts, wind and water** so well that your reputation is protected whatever the weather.

QUALITY SO SOLID, THE WARRANTY IS TRANSFERABLE.*

Most other window and door warranties end when a home is sold, but our coverage — 20 years on glass, 10 years on non-glass parts — transfers from each homeowner to the next. And, because it's not prorated, the coverage offers **full benefits, year after year, owner after owner** for real added value.

OWNER2OWNER®
LIMITED WARRANTY

DESIGNED FOR PERFORMANCE.

100 Series products are designed to meet or exceed performance requirements in all 50 states†. See pages 103-104 for details.

PG50^{††}

PERFORMANCE
OPTIONAL PERFORMANCE UPGRADE

100SHS4066 DPUP IG +50/-50
(AAMA/WDMA/CSA 101/I.S.2/A440-08 & -11)

* Visit andersenwindows.com/warranty for details.

** Units with black, dark bronze or Sandtone interiors have matching exteriors.

† See your local code official for code requirements in your area.

†† 100SHS4066 DPUP IG +50/-50 (AAMA/WDMA/CSA 101/I.S.2/A440-08 & -11). Optional PG50 Performance Upgrade is available for most sizes. For more information, visit andersenwindows.com/100series



FIBREX[®] MATERIAL

STRONG ON PERFORMANCE. GENTLE ON THE ENVIRONMENT.

Developed by Andersen, Fibrex[®] material is a revolutionary structural composite material that blends the very best attributes of vinyl and wood. Fibrex material saves on natural resources because it is composed of 40% reclaimed wood fiber by weight. Special polymer formulations surround and fill each wood fiber, enabling top performance. The result is a material that provides uncommon value and enhances the quality of any project. In use for over two decades in Andersen[®] products, Fibrex material has proven its strength and durability in all types of climates.

REVOLUTIONARY BUILDING MATERIAL

- Twice as strong as vinyl, so weathertight seals stay weathertight
- Blocks thermal transfer nearly 700 times better than aluminum to help reduce heating and cooling bills
- Retains its stability and rigidity in all climates for exceptional durability
- Offers superior scratch resistance compared to painted vinyl*

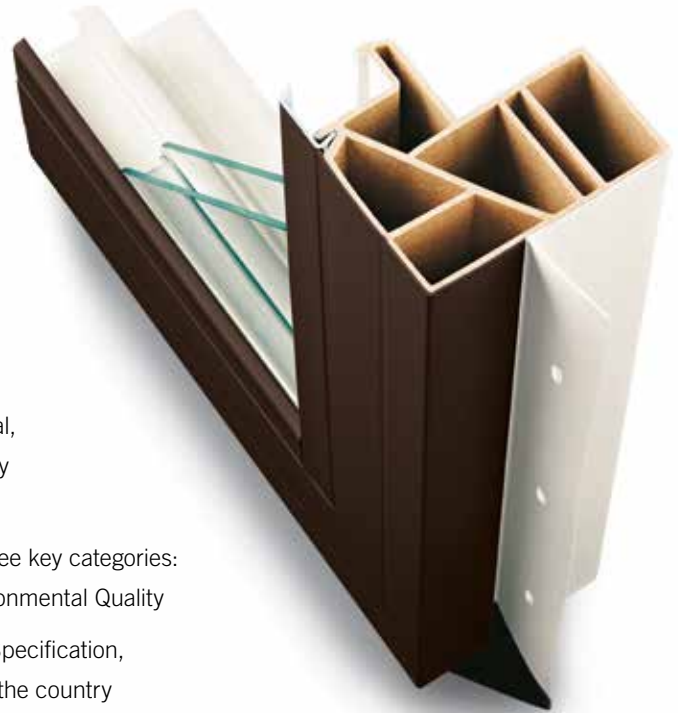

ENVIRONMENTALLY RESPONSIBLE

- Since Andersen developed the highly sustainable Fibrex material, reuse of waste wood fiber has prevented the harvesting of nearly 90 million board feet of timber
- 100 Series products can help builders earn LEED[®] points in three key categories: Energy & Atmosphere, Materials & Resources and Indoor Environmental Quality
- 100 Series products meet or exceed California Section 01350 Specification, a California indoor emission standard — one of the toughest in the country
- Like all Andersen products, 100 Series products are designed to last** and help reduce future waste streams



See how Andersen created Fibrex material at andersenwindows.com/fibrex

* Visit andersenwindows.com/warranty for details.

** When tested against five leading competitors' painted vinyl window products.

✓ STABLE & PREDICTABLE

Fibrex® material is twice as stiff as vinyl.
This strength makes it a better choice over time.

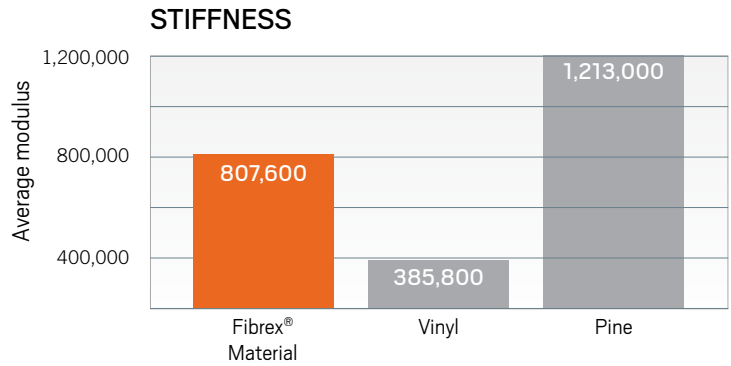

✓ DURABLE & RELIABLE

All materials expand and contract when exposed to extreme temperatures. In these types of conditions, Fibrex material performs twice as well as vinyl, which can bow and crack over time.

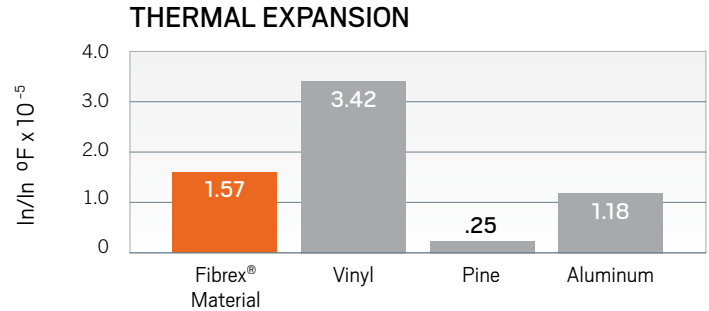

✓ AN EXCELLENT INSULATOR

The built-in thermal qualities of Fibrex material mean that less heat and cold get transferred through the unit into your customers' homes. As an insulator, it is on par with vinyl and far superior to aluminum.

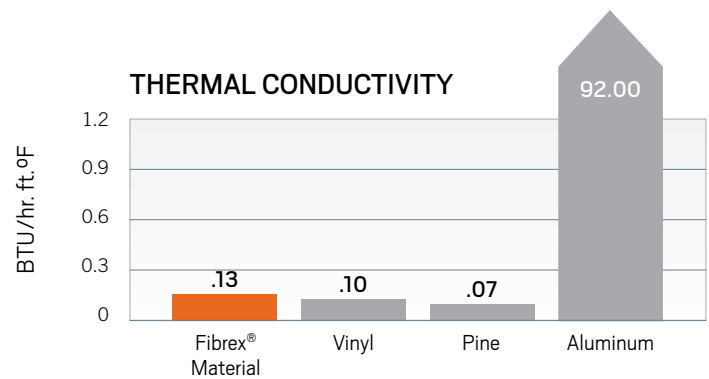

✓ MOISTURE-RESISTANT

Because Fibrex material combines wood fiber and a special polymer formula, water has a tough time penetrating. The result is an increased resistance to rot.

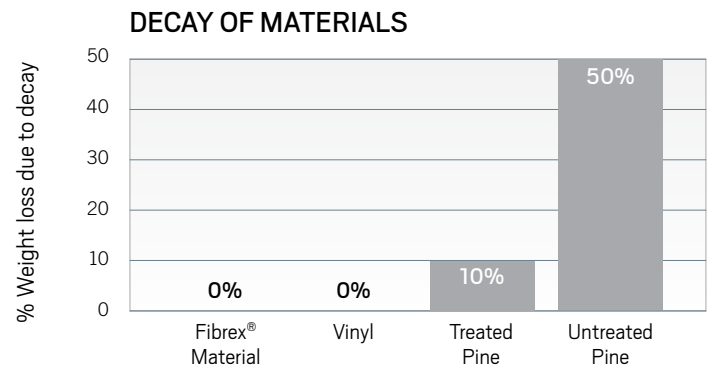

✓ HEAT-RESISTANT

Fibrex material can withstand temperatures in excess of 150°F, even in dark colors.

ANDERSEN DELIVERS, WHATEVER YOUR PROJECT.

NEW CONSTRUCTION

You'll find a 100 Series window or door to match any project from commercial to residential — no matter the location. And with uniform sight lines, it's easy to specify 100 Series products for the entire project.

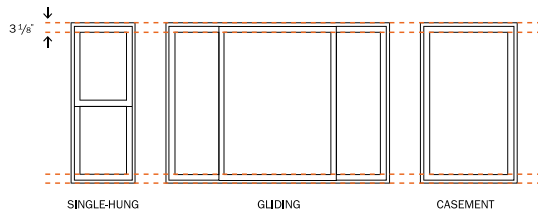

An **extension jamb attachment flange** is available for easy application of extension jambs on the jobsite.

Single-hung drywall pass-through windows have an upper sash that can be easily removed on the jobsite after the window is installed. With both sash removed, drywall can easily fit through upper floor windows.

1 3/8" Flange Setback Frame has an integral installation flange that makes it easy to install windows into a new opening and helps make sure the windows and doors are weathertight.

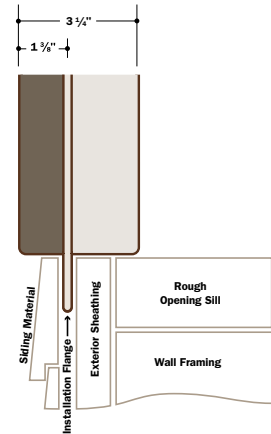

1" Flange Setback Frame with Stucco Key has a stucco key to eliminate gaps that can result from the natural contraction of exterior stucco. The integral installation flange makes it easy to install windows into a new opening and helps make sure the windows and doors are weathertight.

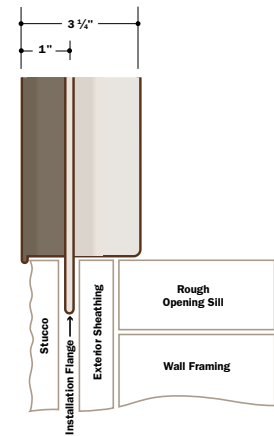



REMODELING & REPLACING

Whether you're adding or updating, Andersen® 100 Series windows and patio doors enhance any project with beauty, craftsmanship and time-tested performance. Available in a variety of styles, shapes and colors with custom sizing in $\frac{1}{8}$ " increments, 100 Series products allow you to create the look your customers want. The no flange frame options also include predrilled through-the-jamb installation holes and installation screws to save you time.

No Flange Frame allows for full removal of the existing window in situations where the frame is rotten or damaged. The no flange window is then installed into the existing rough opening.

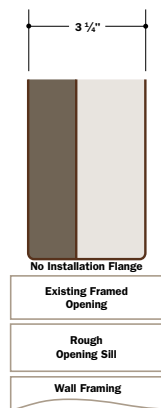

Insert Frame provides fast and easy window replacement when installing the window into an existing window frame without disturbing the interior or exterior trim, saving time and money. The exterior accessory kerf allows for convenient finishing of the window. An exterior sill extender is available to fill the gap at the sill. Exterior frame extenders and a head expander are also available.

NEW!

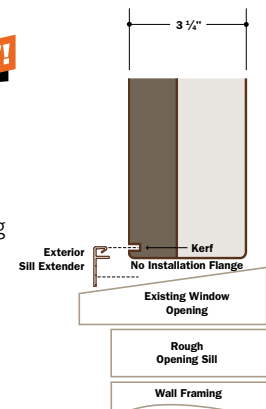

WINDOW & DOOR TYPES

CASEMENT & AWNING WINDOWS

Casement windows are hinged on the side and open outward to the left or right, while awning windows are hinged at the top and open outward. Both are also available as non-operating stationary windows.



Sandtone

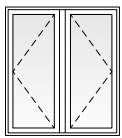

Twin Casement

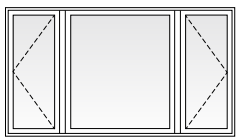

Picture with Flanking Casements

SINGLE-HUNG WINDOWS

Single-hung windows feature a fixed upper sash with an operable lower sash that slides up and down. For convenience, the hardware locks automatically when the window is closed. An arch single-hung is also available to add architectural interest.



Dark Bronze

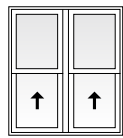

Twin Single-Hung



Arch Single-Hung

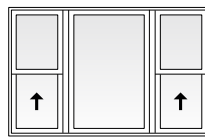

Picture with Flanking Single-Hungs

GLIDING WINDOWS

Gliding windows have one stationary sash and one operating sash that glides horizontally. A three-sash configuration, where two sash glide past a fixed center sash, is also available.



Black

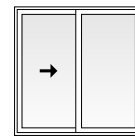

Gliding
Active-Stationary

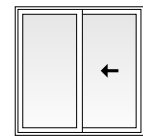

Gliding
Stationary-Active

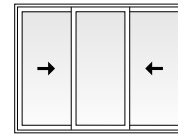

Gliding
Active-Stationary-Active, 1:1:1 Sash Ratio

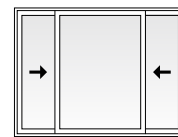

Gliding
Active-Stationary-Active, 1:2:1 Sash Ratio



Available in custom sizes to fit all projects.

PICTURE, TRANSOM & SPECIALTY WINDOWS

Choose from a variety of shapes to make a signature statement or provide a delicate lighting accent. Shapes include arch, Springline™, half circle, quarter circle and rectangular picture or transom windows. Custom shapes are also available including: full circle, triangle, trapezoid, pentagon, octagon and unequal leg arch windows.



Terratone

GLIDING PATIO DOORS

Patio doors feature one stationary panel and one operating panel that glides smoothly on adjustable rollers. They feature a multi-point locking system for enhanced security and an optional exterior keyed lock for convenience. Sidelights and transoms are also available.



White



COLOR OPTIONS

EXTERIOR COLORS

100 Series windows and patio doors come in five exterior colors, including dark bronze and black — colors that are darker and richer than those of most vinyl windows.



White

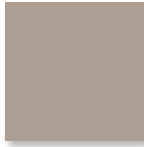

Sandtone

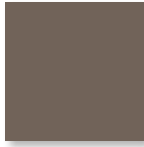

Terratone



Dark Bronze



Black

INTERIOR COLORS

100 Series windows and patio doors feature a premium matte finish inside for an attractive appearance.

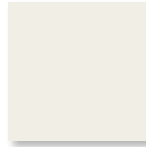

White

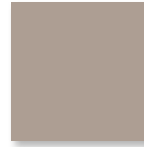

Sandtone*

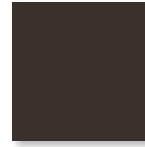

Dark Bronze*

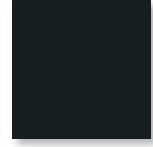

Black*

* Products with dark bronze, black and Sandtone interiors have matching exteriors. Printing limitations prevent exact duplication of colors. See your Andersen supplier for actual color samples.





HARDWARE OPTIONS

WINDOWS

Single-Hung & Gliding



Lock



Lift/Pull (Optional)

Lock automatically engages when window is closed.
Hardware color matches the window's interior. Shown in white.

Optional Slim Line Metal Hardware



Lock

Antique Brass | Black | **Dark Bronze** | Sandtone | Satin Nickel | White

Casement & Awning



Antique Brass | Black | Dark Bronze | Sandtone | Satin Nickel | White

Folding handle avoids interference with window treatments.

PATIO DOORS

Tulsa Hardware



Exterior



Interior

Exterior handle matches exterior door color. Shown in dark bronze.

Interior handle matches interior door color. Shown in white.

Optional Afton Hardware



Exterior



Interior

Antique Brass | Bright Brass
Black | **Satin Nickel**

Optional auxiliary foot lock is available to secure the gliding panel and provides an extra measure of security when the door is in a locked position.

Wireless open/close sensors are available. See your Andersen supplier for details.

Bold name denotes finish shown.

Printing limitations prevent exact finish replication. See your Andersen supplier for actual finish samples.

GLASS OPTIONS

Andersen has the glass you need to get the performance you want with options for every climate, project and customer. Check with your supplier for the selections that meet ENERGY STAR® requirements in your area.

GLASS	ENERGY		LIGHT	
	U-FACTOR	SOLAR HEAT GAIN COEFFICIENT	VISIBLE LIGHT TRANSMITTANCE	UV PROTECTION
	How well a product prevents heat from escaping.	How well a product blocks heat caused by sunlight.	How much visible light comes through a product.	How well a product blocks ultraviolet rays.
SmartSun™ Thermal control similar to tinted glass, with visible light transmittance similar to Low-E glass.	★★★★☆	★★★★★	★★★☆☆	★★★★★
SmartSun with HeatLock® Coating Applied to the room-side surface, it reflects heat back into the home and improves U-Factors.	★★★★☆	★★★★★	★★☆☆☆	★★★★★
Low-E Outstanding overall performance for climates where both heating and cooling costs are a concern.	★★★★☆	★★★★☆	★★★★☆	★★★★☆
Low-E with HeatLock® Coating Applied to the room-side surface, it reflects heat back into the home and improves U-Factors.	★★★★☆	★★★★☆	★★★☆☆	★★★★☆
Sun Outstanding thermal control in southern climates where less solar heat gain is desired.	★★★★☆	★★★★★	★★☆☆☆	★★★★☆
Clear Dual-Pane High visibility with basic thermal performance.	★★☆☆☆	☆☆☆☆	★★★★★	☆☆☆☆

Center of glass performance only. Ratings based on glass options available as of June 2019. Visit andersenwindows.com/energystar for ENERGY STAR® map and NFRC total unit performance data.

TIME-SAVING FILM

We help protect our products during delivery and construction with a translucent film that peels away for a spotless window.



ADDITIONAL GLASS OPTIONS

Tempered safety glass is available and is standard on gliding patio doors. Sound reducing glass options are also available.

Patterned glass lets in light while obscuring vision and adds a unique, decorative touch.



Obscure Reed Cascade Fern

Cascade and Reed patterns are only available in a vertical orientation.

GRILLE OPTIONS

Grilles for Andersen® 100 Series windows and patio doors are available in a wide variety of patterns to complement virtually any style of home. Plus, they have options for easy cleaning and architectural authenticity many vinyl windows can't match.

Finelight™ Grilles-Between-the-Glass

make glass easy to clean. They have an elegant, sculpted profile, plus they offer a two-sided color scheme, allowing them to match both the interior and exterior of the window or patio door.



Finelight Grilles-Between-the-Glass with Exterior Grilles

make interior glass easier to clean, while permanent exterior grilles provide architectural style and detail.



Full Divided Light

feature grilles permanently applied to the interior and exterior of the window with a spacer between the glass for an authentic look.

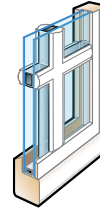

Simulated Divided Light

offers permanent grilles on the exterior and interior with no spacer between the glass.

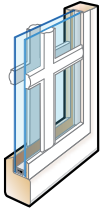

GRILLE PATTERNS

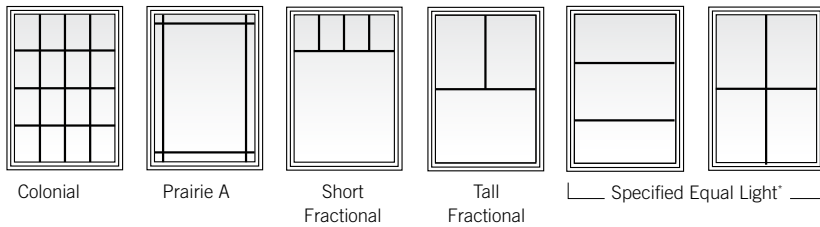

GRILLE BAR WIDTHS

Actual size shown.

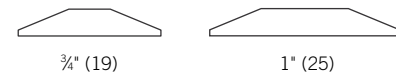

Grille width for windows is 3/4" (19). Grille width for patio doors is 1" (25). A 2 1/4" (57) simulated meeting rail is available for casement windows to replicate the look of single-hung windows.

To see all of the standard patterns available for a specific window or door, refer to the detailed sections in this book for each product or contact your Andersen supplier.

INSECT SCREEN OPTIONS

Insect screens for windows and patio doors have a fiberglass screen mesh. Optional TruScene® insect screens for windows are made with a micro-fine stainless steel mesh, providing 50% more clarity than our conventional insect screens.

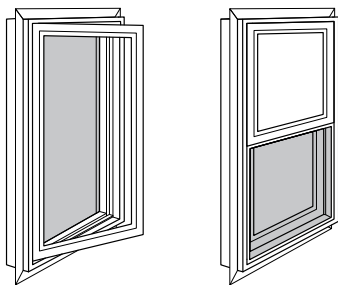

Insect screens are available for all venting windows.

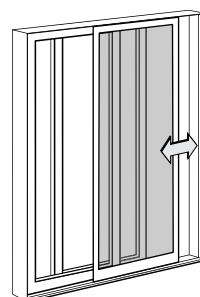

Gliding insect screens are available for two-panel doors.

* Specify number of same-size rectangles across or down. Dimensions in parenthesis are in millimeters.

CREATE 2-WAY COMBINATIONS WITH 100 SERIES WINDOWS. NEW!

Design with monumental window combinations in mind that maximize light and view and make a signature statement in any home or commercial building. Andersen® reinforced joining options provide enhanced performance, design flexibility and the ultimate in jobsite conveniences. This innovative joining system utilizes the strength and durability of fiberglass construction and allows window combinations to be joined at the factory, on the jobsite or in the rough opening. For more information, visit andersenwindows.com/joining.

Coming Soon

Easy Connect Joining System

Receive lighter, easier-to-handle, pre-assembled smaller combinations that join together as you install them into the rough opening, making it easier to install large combinations.

In fact, most contractors surveyed said they could **reduce the number of installers by 50% using the Andersen Easy Connect Joining System.**

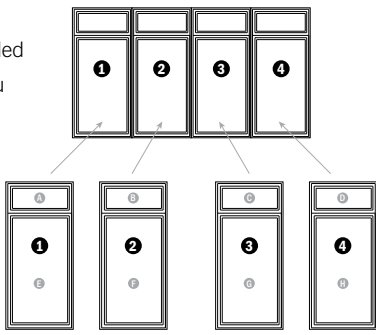

Factory-Joined Combinations

Eliminate the need for jobsite assembly and receive fully joined, factory-assembled window combinations to fit rough openings up to 12' x 8' or 8' x 12'.

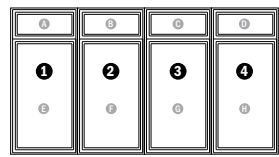

	REINFORCED FACTORY-JOINED COMBINATIONS	REINFORCED JOINING KITS	REINFORCED EASY CONNECT JOINING SYSTEM
ASSEMBLY	FACTORY	JOBSITE	IN THE OPENING
READY TO INSTALL	●		●
NUMBER OF INSTALLERS*	MORE	MORE	FEWER
HALLMARK CERTIFIED for air, water and structural performance**	●	●	●
Tested to AAMA 450	●	●	●
PERFORMANCE	EXTENSIVE UNIT COMBINATION SIZE OPTION AVAILABLE CERTIFIED TO PG50**	EXTENSIVE UNIT COMBINATION SIZE OPTION AVAILABLE CERTIFIED TO PG50**	EXTENSIVE UNIT COMBINATION SIZE OPTION AVAILABLE CERTIFIED TO PG50**
COMBINATION SIZE LIMITATIONS	MAX. JOIN LENGTH: 12' MAX. JOINED COMBINATION: 12' x 8' or 8' x 12' (3658 x 2438) or (2438 x 3658) 96 sq.ft. or 8.92 m ²	MAX. JOIN LENGTH: 12' MAX. JOINED COMBINATION: 16' x 9' or 12' x 12' (4877 x 2743) or (3658 x 3658) 144 sq.ft. or 13.34 m ²	MAX. JOIN LENGTH: 12' MAX. JOINED COMBINATION: 16' (4877) HIGH NO MAXIMUM WIDTH

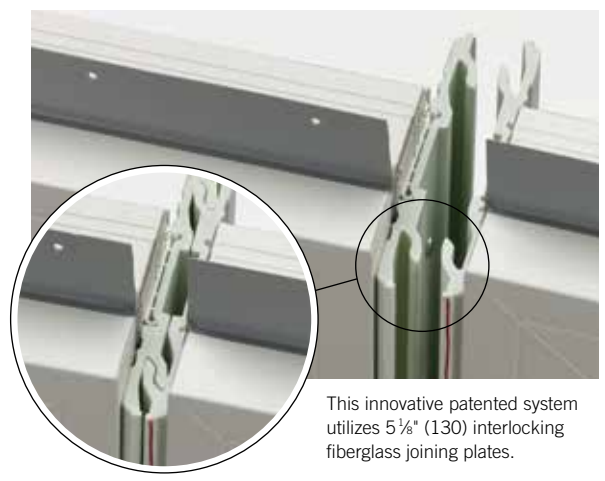

This innovative patented system utilizes 5 1/8" (130) interlocking fiberglass joining plates.



* 69% of 156 builders/general contractors in a 2018 survey said they could reduce the number of installers by half using the Easy Connect Joining System when comparing the installation of a 12' wide x 8' high pre-assembled window combination unit with four 3' wide x 8' high window combination units.

** When installed according to Andersen installation instructions. Dimensions in parentheses are in millimeters.

WINDOWS

SECTION REFERENCE

Casement

- Table of Sizes 18-20
- Specifications 21-22
- Grille Patterns 22
- Window Details 23-24

Awning

- Table of Sizes 25-26
- Grille Patterns 26
- Specifications 27
- Window Details 28-29

Single-Hung

- Table of Sizes 30-47
- Specifications 31-33, 39-45
- Grille Patterns 47
- Window Details 48-51

Gliding

- Table of Sizes 52-57
- Specifications 58-63
- Grille Patterns 63
- Window Details 64-65

Picture, Transom & Specialty

- Table of Sizes 66-79
- Specifications 68-71, 80
- Custom Shapes 74-75
- Grille Patterns 77
- Window Details 81-83
- Joining Details 84-87
- Custom Sizing 88-90
- Combination Designs 99
- Product Performance 102

CUSTOM SIZING

in 1/8" (3) increments



Dimensions in parentheses are in millimeters.



WINDOWS

FEATURES

CASEMENT & AWNING

Frame

A Frame constructed with Fibrex® composite material. This construction produces a rigid frame.

B Durable, low-maintenance finish won't fade, flake, blister or peel.*

Concealed receiving brackets mounted on the hinge side of the frame keep the sash tightly secured within the window frame when closed.

C Four frame options available, see below.

Sash

D Fibrex material construction provides long-lasting performance.† The sash, finished with a durable capping, provides maximum protection and a matte, low-maintenance finish.

E The dual weatherstrip system combines both an exterior watershed design and a bulb weatherstrip seal between the sash and frame. The result is a long-lasting, energy-efficient barrier against wind, water and dust.

Glass

F A glazing bead and silicone provides superior weathertightness and durability.

G See below for details.

Hardware

Sash operator provides almost effortless opening and closing, regardless of unit size.

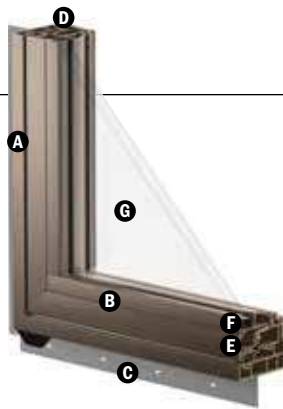

Long-lasting stainless steel hinge channels are used at the head and sill to provide easy operation.

Single-Action Casement Lock

Single-action lock easily releases all concealed locking points on casement sash. The lock and folding handle match the window's interior color.

Awning Sash Locks



Awning sash locks provide an added measure of security and weathertightness. Awning hardware style and color options are compatible with 100 Series casement windows to ensure a consistent appearance when used in combination designs.

SINGLE-HUNG

Frame

A Frame constructed with Fibrex composite material. This construction produces a rigid frame.

B A durable, side-loaded balancer provides for easy sash opening and closing. The lower sash can be removed without the use of tools.

C Durable, low-maintenance finish won't fade, flake, blister or peel.*

D Four frame options available, see below.

E Weep holes are located on the exterior nose of sill for proper water management.

Sash

The lower sash has a meeting rail cover with a unique raised profile design, allowing the sash to be opened and closed easily.

F Fibrex material construction provides long-lasting performance.† The sash, finished with a durable capping, provides maximum protection and a matte, low-maintenance finish.

G Dual-felt weatherstrip provides a long-lasting, energy-efficient barrier against wind, water and dust.

Glass

H A glazing bead and silicone provides superior weathertightness and durability.

I See below for details.



Hardware

Sash Lock

Sash lock engages automatically when lower sash is closed. The standard sash lock matches the window's interior color. An optional sash lift is available.

Sash Options

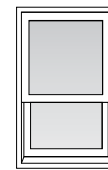

Reverse Cottage Style

Shapes



Arch Single-Hung

COMMON FEATURES

Frame

Four frame options include:

- 1 3/8" (35) flange setback for siding applications. An integral rigid vinyl flange helps seal the unit to the structure.
- 1" (25) flange setback with stucco key. An integral rigid vinyl flange helps seal the unit to the structure.
- No-flange option for window replacement in an existing framed opening.
- Insert option for window replacement in an existing window frame.

Glass

Glazing bead and silicone provide superior weathertightness and durability.

High-Performance glass options include:

- Low-E SmartSun™ glass
- Low-E SmartSun HeatLock® glass
- Low-E glass
- Low-E HeatLock glass
- Low-E Sun™ glass
- Clear dual-pane glass

Tempered glass and other glass options are available. Contact your Andersen supplier.

A removable translucent film helps shield the glass from damage during delivery and construction and simplifies finishing at the jobsite.

Patterned Glass

Patterned glass options are available. See page 12 for more details.

Performance Grade Upgrades

Optional performance grade upgrades are now available for select sizes allowing units to achieve PG50. Performance Grade (PG) Ratings are more comprehensive than Design Pressure (DP) Ratings for measuring product performance. Choosing the PG50 Upgrade does not change the appearance of the unit.

* Visit andersenwindows.com/warranty for details.

** Products with dark bronze, black and Sandtone interiors have matching exteriors.

Printing limitations prevent exact duplications of colors. See your Andersen supplier for actual color samples.

Dimensions in parentheses are in millimeters.

EXTERIOR COLORS

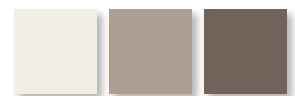

White Sandtone Terratone



Dark Bronze Black

INTERIOR COLORS



White Sandtone**



Dark Bronze** Black**

FEATURES

GLIDING

Frame

- A** Frame constructed with Fibrex® composite material. This construction produces a rigid frame.
- B** Durable, low-maintenance finish won't fade, flake, blister or peel.*
- C** Four frame options available, see page 16.

Sash

- The operating sash has a meeting stile cover with a unique raised profile design, allowing the sash to be opened and closed easily.
- D** Fibrex material construction provides long-lasting performance. The sash, finished with a durable capping, provides maximum protection and a matte, low-maintenance finish.
 - E** Dual-felt weatherstrip provides a long-lasting, energy-efficient barrier against wind, water and dust.
 - F** Operating sash has four metal rollers mounted at the bottom of the sash for easy, smooth travel over the sill.

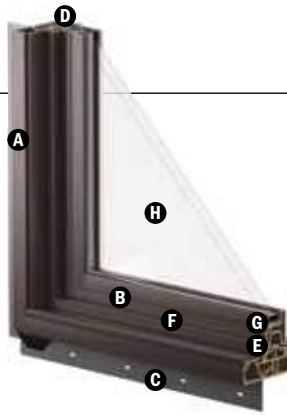

Glass

- G** A glazing bead and silicone provides superior weathertightness and durability.
- H** See page 16 for details.

Hardware

Sash Lock

Gliding window sash lock engages automatically when operable sash is closed. The standard sash lock matches the window's interior color. An optional sash pull is available.

PICTURE, TRANSOM & SPECIALTY

Frame

- A** Frame constructed with Fibrex composite material. This construction produces a rigid frame.
- B** Durable, low-maintenance finish won't fade, flake, blister or peel.*
- C** Four frame options available, see page 16.

Glass

- D** The glass is direct-set into the frame for superior weathertightness and durability.
- E** See page 16 for details.

Shapes

Along with rectangular windows, arch, Springline™ half circle, quarter circle and circle windows are available in both standard and custom sizes. Custom windows are also available in triangle, trapezoid, pentagon, octagon and unequal leg arch shapes.

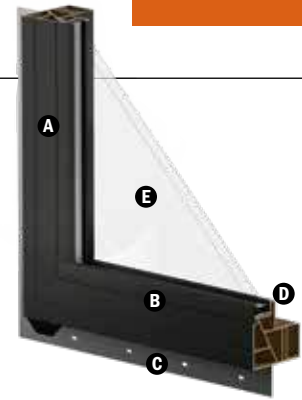

HARDWARE FINISHES



Antique Brass | Black | Dark Bronze | Satin Nickel | Sandtone | White

HARDWARE OPTIONS

Single-Hung & Gliding



Hardware color matches the window's interior.

Optional Slim Line Metal Lock



Antique Brass | Black | **Dark Bronze** | Sandtone | Satin Nickel | White

Casement & Awning



Antique Brass | Black | Dark Bronze | Sandtone | Satin Nickel | White

Folding handle avoids interference with window treatments.

ACCESSORIES Sold Separately

Hardware

Window Opening Control Device

A window opening control device is available for casement, single-hung and gliding windows which limits sash travel to less than 4" (102) when the window is first opened. Available factory-installed or as a kit for field-application.

Vent Limiter

A vent limiter is available for awning windows which prevents opening the sash more than 4" (102). Available factory-installed or as a kit for field-application.

Open/Closed Sensors

Wireless open/closed sensors are available in white, Sandtone and dark bronze.

Grilles

Grilles are available in a variety of configurations. See page 13 for details.

Insect Screens

For casement and awning windows, insect screen frames are color matched to the product interior. For single-hung and gliding windows, stainless steel springs hold the insect screen tightly to the window frame and their frames are available in colors to match the product exteriors. Insect screens have charcoal gray fiberglass screen mesh.

TruScene® Insect Screen

Exclusive Andersen® TruScene insect screens provide over 50% more clarity than our conventional insect screen for a beautiful unobstructed view. They allow more fresh air and sunlight in, while doing a better job of keeping out small insects. Frame color for casement and awning windows matches the product interiors. Frame color for single-hung and gliding matches the product exteriors.

* Visit andersenwindows.com/warranty for details. Dimensions in parentheses are in millimeters.

Bold name denotes finish shown.

Printing limitations prevent exact replication of finishes. See your Andersen supplier for actual finish samples.

CASEMENT WINDOWS

Table of Casement Window Sizes

Scale 1/8" (3) = 1'-0" (305) – 1:96

Window Dimension	1'-5 1/2"	1'-11 1/2"	2'-5 1/2"	2'-11 1/2"
	(445)	(597)	(749)	(902)
Minimum Rough Opening	1'-6"	2'-0"	2'-6"	3'-0"
	(457)	(610)	(762)	(914)
Unobstructed Glass	11 1/4"	17 1/4"	23 1/4"	29 1/4"
	(286)	(438)	(591)	(743)

CUSTOM WIDTHS – 17 1/2" to 35 1/2"				
Window Dimension	CUSTOM HEIGHTS – 23 1/2" to 71 1/2"			
	1'-11 1/2"	1620	2020	2620
2'-5 1/2"	1626	2026	2626	3026
2'-11 1/2"	1630	2030	2630	3030
3'-5 1/2"	1636	2036	2636	3036 ^o
3'-11 1/2"	1640	2040	2640 ^o	3040 ^o
4'-5 1/2"	1646	2046	2646 ^o	3046 ^o
4'-11 1/2"	1650	2050	2650 ^o	3050 ^o
5'-5 1/2"	1656	2056	2656 ^o	3056 ^o
5'-11 1/2"	1660	2060	2660 ^o	3060 ^o



Custom-size windows are available in 1/8" (3) increments.

See page 88 for custom sizes and specifications.

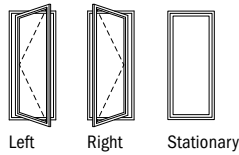

Choose left, right or stationary as viewed from the exterior. Right venting shown in table.

Details shown on pages 23-24.

Grille patterns shown on page 22.

* "Window Dimension" always refers to outside frame to frame dimension.
 • "Minimum Rough Opening" dimensions may need to be increased to allow for use of building wraps, flashing, sill panning, brackets, fasteners or other items. See page 109 for more details.
 • Dimensions in parentheses are in millimeters.
 ◊ Meet or exceed clear opening area of 5.7 sq.ft. or 0.53 m², clear opening width of 20" (508) and clear opening height of 24" (610). See table on page 21.

Table of Twin Casement Window Sizes

Scale 1/8" (3) = 1'-0" (305) – 1:96

Window Dimension	2'-11 1/2" (902)	3'-5 1/2" (1054)	3'-11 1/2" (1207)	4'-5 1/2" (1359)	4'-11 1/2" (1511)	5'-5 1/2" (1664)	5'-11 1/2" (1816)
Minimum Rough Opening	3'-0" (914)	3'-6" (1067)	4'-0" (1219)	4'-6" (1372)	5'-0" (1524)	5'-6" (1676)	6'-0" (1829)
Unobstructed Glass (width of single sash)	11 1/4" (286)	14 1/4" (362)	17 1/4" (438)	20 1/4" (514)	23 1/4" (591)	26 1/4" (667)	29 1/4" (743)
11 1/2" (292)							
1-5 1/2" (445)							
1-11 1/2" (597)							
CUSTOM WIDTHS – 35 1/2" to 71 1/2"							
1-11 1/2" (597)							
2-5 1/2" (749)							
2-11 1/2" (902)							
3-5 1/2" (1054)							
3-11 1/2" (1207)							
4-5 1/2" (1359)							
4-11 1/2" (1511)							
5-5 1/2" (1664)							
5-11 1/2" (1816)							



Custom-size windows are available in 1/8" (3) increments. See page 88 for custom sizes and specifications.

Choose left, right or stationary as viewed from the exterior. In addition to venting shown, other standard configurations are available. Windows have one continuous outer frame.

Twin transoms are also shown. See pages 70-71 for more information.

Details shown on pages 23-24. Grille patterns shown on page 22.

100 Series Casement & Awning Windows

* "Window Dimension" always refers to outside frame to frame dimension.
 ** "Minimum Rough Opening" dimensions may need to be increased to allow for use of building wraps, flashing, sill panning, brackets, fasteners or other items. See page 109 for more details.
 • Dimensions in parentheses are in millimeters.
 ◊ Meet or exceed clear opening area of 5.7 sq.ft. or 0.53 m², clear opening width of 20" (508) and clear opening height of 24" (610). See table on pages 21-22.

CASEMENT WINDOWS

Table of Sizes for Picture Window with Flanking Casements

Scale 1/8" (3) = 1'-0" (305) – 1:96

Window Dimension	5'-11 1/2" (1816)	7'-11 1/2" (2426)	9'-11 1/2" (3035)	11'-11 1/2" (3645)
Minimum Rough Opening	6'-0" (1829)	8'-0" (2438)	10'-0" (3048)	12'-0" (3658)
Unobstructed Glass (width of center sash)	29 1/4" (743)	41 1/4" (1048)	53 1/4" (1353)	65 1/4" (1657)
Unobstructed Glass (width of single flanking sash)	11 1/4" (286)	17 1/4" (438)	23 1/4" (591)	29 1/4" (743)

11'-1/2" (292)	1'-0" (305)	5'-1/4" (133)				
1'-5 1/2" (445)	1'-6" (457)	11'-1/4" (286)	16-3016-16	20-4016-20	26-5016-26	30-6016-30
1'-11 1/2" (597)	2'-0" (610)	17'-1/4" (438)	16-3020-16	20-4020-20	26-5020-26	30-6020-30
1'-11 1/2" (597)	2'-0" (610)	17'-1/4" (438)				
2'-5 1/2" (749)	2'-6" (762)	23 1/4" (591)	16-3026-16	20-4026-20	26-5026-26	30-6026-30
2'-11 1/2" (902)	3'-0" (914)	29 1/4" (743)	16-3030-16	20-4030-20	26-5030-26	30-6030-30
3'-5 1/2" (1054)	3'-6" (1067)	35 1/4" (895)	16-3036-16	20-4036-20	26-5036-26	30-6036-30 ^o
3'-11 1/2" (1207)	4'-0" (1219)	41 1/4" (1048)	16-3040-16	20-4040-20	26-5040-26 ^o	30-6040-30 ^o
4'-5 1/2" (1359)	4'-6" (1372)	47 1/4" (1200)	16-3046-16	20-4046-20	26-5046-26 ^o	30-6046-30 ^o
4'-11 1/2" (1511)	5'-0" (1524)	53 1/4" (1353)	16-3050-16	20-4050-20	26-5050-26 ^o	30-6050-30 ^o
5'-5 1/2" (1664)	5'-6" (1676)	59 1/4" (1505)	16-3056-16	20-4056-20	26-5056-26 ^o	30-6056-30 ^o
5'-11 1/2" (1816)	6'-0" (1829)	65 1/4" (1657)	16-3060-16	20-4060-20	26-5060-26 ^o	30-6060-30 ^o

Choose left, right or stationary as viewed from the exterior. In addition to venting shown, other standard configurations are available. Windows have one continuous outer frame.

Transoms are also shown. See pages 70-71 for more information.

Details shown on pages 23-24. Grille patterns shown on page 22.

* "Window Dimension" always refers to outside frame to frame dimension.
 • "Minimum Rough Opening" dimensions may need to be increased to allow for use of building wraps, flashing, sill panning, brackets, fasteners or other items. See page 109 for more details.
 • Dimensions in parentheses are in millimeters.
^o Meet or exceed clear opening area of 5.7 sq.ft. or 0.53 m², clear opening width of 20" (508) and clear opening height of 24" (610).

Casement Window Opening and Area Specifications

Window Number	Clear Opening Area Sq. Ft./ (m ²)	Clear Opening in Full Open Position		Glass Area Sq. Ft./ (m ²)	Vent Area Sq. Ft./ (m ²)	Top of Subfloor to Top of Inside Sill Stop Inches/(mm)	Overall Window Area Sq. Ft./ (m ²)	Hinge Type
		Width Inches/(mm)	Height Inches/(mm)					
1620	0.67 (0.06)	5 3/8" (137)	17 13/16" (452)	1.35 (0.13)	1.46 (0.14)	61 9/16" (1564)	2.86 (0.27)	wash mode
1626	0.89 (0.08)	5 3/8" (137)	23 13/16" (605)	1.82 (0.17)	1.95 (0.18)	55 9/16" (1411)	3.59 (0.33)	wash mode
1630	1.12 (0.10)	5 3/8" (137)	29 13/16" (757)	2.29 (0.21)	2.44 (0.23)	49 9/16" (1259)	4.31 (0.40)	wash mode
1636	1.34 (0.12)	5 3/8" (137)	35 13/16" (909)	2.75 (0.26)	2.94 (0.27)	43 9/16" (1106)	5.04 (0.47)	wash mode
1640	1.57 (0.15)	5 3/8" (137)	41 13/16" (1062)	3.22 (0.30)	3.43 (0.32)	37 9/16" (954)	5.77 (0.54)	wash mode
1646	1.79 (0.17)	5 3/8" (137)	47 13/16" (1214)	3.69 (0.34)	3.92 (0.36)	31 9/16" (802)	6.50 (0.60)	wash mode
1650	2.02 (0.19)	5 3/8" (137)	53 13/16" (1367)	4.16 (0.39)	4.41 (0.41)	25 9/16" (649)	7.23 (0.67)	wash mode
1656	2.24 (0.21)	5 3/8" (137)	59 13/16" (1519)	4.63 (0.43)	4.90 (0.46)	19 9/16" (497)	7.96 (0.74)	wash mode
1660	2.47 (0.23)	5 3/8" (137)	65 13/16" (1671)	5.10 (0.47)	5.40 (0.50)	13 9/16" (344)	8.69 (0.81)	wash mode
2020	1.41 (0.13)	11 3/8" (289)	17 13/16" (452)	2.07 (0.19)	2.20 (0.20)	61 9/16" (1564)	3.84 (0.36)	wash mode
2026	1.88 (0.18)	11 3/8" (289)	23 13/16" (605)	2.79 (0.26)	2.94 (0.27)	55 9/16" (1411)	4.81 (0.45)	wash mode
2030	2.36 (0.22)	11 3/8" (289)	29 13/16" (757)	3.50 (0.33)	3.69 (0.34)	49 9/16" (1259)	5.79 (0.54)	wash mode
2036	2.83 (0.26)	11 3/8" (289)	35 13/16" (909)	4.22 (0.39)	4.43 (0.41)	43 9/16" (1106)	6.77 (0.63)	wash mode
2040	3.31 (0.31)	11 3/8" (289)	41 13/16" (1062)	4.94 (0.46)	5.17 (0.48)	37 9/16" (954)	7.75 (0.72)	wash mode
2046	3.78 (0.35)	11 3/8" (289)	47 13/16" (1214)	5.66 (0.53)	5.91 (0.55)	31 9/16" (802)	8.73 (0.81)	wash mode
2050	4.26 (0.40)	11 3/8" (289)	53 13/16" (1367)	6.38 (0.59)	6.65 (0.62)	25 9/16" (649)	9.71 (0.90)	wash mode
2056	4.73 (0.44)	11 3/8" (289)	59 13/16" (1519)	7.10 (0.66)	7.40 (0.69)	19 9/16" (497)	10.69 (0.99)	wash mode
2060	5.21 (0.48)	11 3/8" (289)	65 13/16" (1671)	7.82 (0.73)	8.14 (0.76)	13 9/16" (344)	11.67 (1.08)	wash mode
2620	2.15 (0.20)	17 3/8" (442)	17 13/16" (452)	2.79 (0.26)	2.94 (0.27)	61 9/16" (1564)	4.81 (0.45)	wash mode
2626	2.88 (0.27)	17 3/8" (442)	23 13/16" (605)	3.75 (0.35)	3.94 (0.37)	55 9/16" (1411)	6.04 (0.56)	wash mode
2630	3.60 (0.33)	17 3/8" (442)	29 13/16" (757)	4.72 (0.44)	4.93 (0.46)	49 9/16" (1259)	7.27 (0.68)	wash mode
2636	4.33 (0.40)	17 3/8" (442)	35 13/16" (909)	5.69 (0.53)	5.92 (0.55)	43 9/16" (1106)	8.50 (0.79)	wash mode
2640 ◊	6.30 (0.59)	21 13/16" (551)	41 13/16" (1062)	6.66 (0.62)	6.91 (0.64)	37 9/16" (954)	9.73 (0.90)	widest clear opening
2646 ◊	7.21 (0.67)	21 13/16" (551)	47 13/16" (1214)	7.63 (0.71)	7.90 (0.73)	31 9/16" (802)	10.96 (1.02)	widest clear opening
2650 ◊	8.11 (0.75)	21 13/16" (551)	53 13/16" (1367)	8.60 (0.80)	8.90 (0.83)	25 9/16" (649)	12.19 (1.13)	widest clear opening
2656 ◊	9.02 (0.84)	21 13/16" (551)	59 13/16" (1519)	9.57 (0.89)	9.89 (0.92)	19 9/16" (497)	13.42 (1.25)	widest clear opening
2660 ◊	9.92 (0.92)	21 13/16" (551)	65 13/16" (1671)	10.54 (0.98)	10.88 (1.01)	13 9/16" (344)	14.65 (1.36)	widest clear opening
3020	2.89 (0.27)	23 3/8" (594)	17 13/16" (452)	3.50 (0.33)	3.69 (0.34)	61 9/16" (1564)	5.79 (0.54)	wash mode
3026	3.87 (0.36)	23 3/8" (594)	23 13/16" (605)	4.72 (0.44)	4.93 (0.46)	55 9/16" (1411)	7.27 (0.68)	wash mode
3030	4.84 (0.45)	23 3/8" (594)	29 13/16" (757)	5.94 (0.55)	6.17 (0.57)	49 9/16" (1259)	8.75 (0.81)	wash mode
3036 ◊	5.82 (0.54)	23 3/8" (594)	35 13/16" (909)	7.16 (0.67)	7.41 (0.69)	43 9/16" (1106)	10.23 (0.95)	wash mode
3040 ◊	6.79 (0.63)	23 3/8" (594)	41 13/16" (1062)	8.38 (0.78)	8.65 (0.80)	37 9/16" (954)	11.71 (1.09)	wash mode
3046 ◊	7.77 (0.72)	23 3/8" (594)	47 13/16" (1214)	9.60 (0.89)	9.90 (0.92)	31 9/16" (802)	13.19 (1.23)	wash mode
3050 ◊	8.74 (0.81)	23 3/8" (594)	53 13/16" (1367)	10.82 (1.00)	11.14 (1.03)	25 9/16" (649)	14.67 (1.36)	wash mode
3056 ◊	9.72 (0.90)	23 3/8" (594)	59 13/16" (1519)	12.04 (1.12)	12.38 (1.15)	19 9/16" (497)	16.15 (1.50)	wash mode
3060 ◊	10.69 (0.99)	23 3/8" (594)	65 13/16" (1671)	13.25 (1.23)	13.62 (1.27)	13 9/16" (344)	17.63 (1.64)	wash mode

Twin Casement Window Opening and Area Specifications

Window Number	Clear Opening Area Sq. Ft./ (m ²)	Clear Opening in Full Open Position		Glass Area Sq. Ft./ (m ²)	Vent Area Sq. Ft./ (m ²)	Top of Subfloor to Top of Inside Sill Stop Inches/(mm)	Overall Window Area Sq. Ft./ (m ²)	Hinge Type
		Width Inches/(mm)	Height Inches/(mm)					
1620-2	0.67 (0.06)	5 3/8" (137)	17 13/16" (452)	2.70 (0.25)	2.92 (0.27)	61 9/16" (1564)	5.79 (0.54)	wash mode
1626-2	0.89 (0.08)	5 3/8" (137)	23 13/16" (605)	3.63 (0.34)	3.90 (0.36)	55 9/16" (1411)	7.27 (0.68)	wash mode
1630-2	1.12 (0.10)	5 3/8" (137)	29 13/16" (757)	4.57 (0.42)	4.89 (0.45)	49 9/16" (1259)	8.75 (0.81)	wash mode
1636-2	1.34 (0.12)	5 3/8" (137)	35 13/16" (909)	5.51 (0.51)	5.87 (0.55)	43 9/16" (1106)	10.23 (0.95)	wash mode
1640-2	1.57 (0.15)	5 3/8" (137)	41 13/16" (1062)	6.45 (0.60)	6.86 (0.64)	37 9/16" (954)	11.71 (1.09)	wash mode
1646-2	1.79 (0.17)	5 3/8" (137)	47 13/16" (1214)	7.38 (0.69)	7.84 (0.73)	31 9/16" (802)	13.19 (1.23)	wash mode
1650-2	2.02 (0.19)	5 3/8" (137)	53 13/16" (1367)	8.32 (0.77)	8.82 (0.82)	25 9/16" (649)	14.67 (1.36)	wash mode
1656-2	2.24 (0.21)	5 3/8" (137)	59 13/16" (1519)	9.26 (0.86)	9.81 (0.91)	19 9/16" (497)	16.15 (1.50)	wash mode
1660-2	2.47 (0.23)	5 3/8" (137)	65 13/16" (1671)	10.20 (0.95)	10.79 (1.00)	13 9/16" (344)	17.63 (1.64)	wash mode
1920-2	1.04 (0.10)	8 3/8" (213)	17 13/16" (452)	3.41 (0.32)	3.66 (0.34)	61 9/16" (1564)	6.77 (0.63)	wash mode
1926-2	1.39 (0.13)	8 3/8" (213)	23 13/16" (605)	4.60 (0.43)	4.90 (0.45)	55 9/16" (1411)	8.50 (0.79)	wash mode
1930-2	1.74 (0.16)	8 3/8" (213)	29 13/16" (757)	5.79 (0.54)	6.13 (0.57)	49 9/16" (1259)	10.23 (0.95)	wash mode
1936-2	2.09 (0.19)	8 3/8" (213)	35 13/16" (909)	6.98 (0.65)	7.36 (0.68)	43 9/16" (1106)	11.96 (1.11)	wash mode
1940-2	2.44 (0.23)	8 3/8" (213)	41 13/16" (1062)	8.16 (0.76)	8.60 (0.80)	37 9/16" (954)	13.69 (1.27)	wash mode
1946-2	2.79 (0.26)	8 3/8" (213)	47 13/16" (1214)	9.35 (0.87)	9.83 (0.91)	31 9/16" (802)	15.42 (1.43)	wash mode
1950-2	3.14 (0.29)	8 3/8" (213)	53 13/16" (1367)	10.54 (0.98)	11.06 (1.03)	25 9/16" (649)	17.15 (1.59)	wash mode
1956-2	3.49 (0.32)	8 3/8" (213)	59 13/16" (1519)	11.73 (1.09)	12.30 (1.14)	19 9/16" (497)	18.88 (1.75)	wash mode
1960-2	3.84 (0.36)	8 3/8" (213)	65 13/16" (1671)	12.91 (1.20)	13.53 (1.26)	13 9/16" (344)	20.61 (1.91)	wash mode

* "Top of Subfloor to Top of Inside Sill Stop" is calculated based upon a structural header height of 6'-10 1/2" (2096).
 * Dimensions in parentheses are in millimeters or meters squared.
 ◊ Meet or exceed clear opening area of 5.7 sq.ft. or 0.53 m², clear opening width of 20" (508) and clear opening height of 24" (610).

continued on next page

CASEMENT WINDOWS

Twin Casement Window Opening and Area Specifications (continued)

Window Number	Clear Opening Area Sq. Ft./ (m^2)	Clear Opening in Full Open Position		Glass Area Sq. Ft./ (m^2)	Vent Area Sq. Ft./ (m^2)	Top of Subfloor to Top of Inside Sill Stop Inches/(mm)	Overall Window Area Sq. Ft./ (m^2)	Hinge Type
		Width Inches/(mm)	Height Inches/(mm)					
2020-2	1.41 (0.13)	11 3/8" (289)	17 13/16" (452)	4.13 (0.38)	4.40 (0.41)	61 9/16" (1564)	7.75 (0.72)	wash mode
2026-2	1.88 (0.18)	11 3/8" (289)	23 13/16" (605)	5.57 (0.52)	5.89 (0.55)	55 9/16" (1411)	9.73 (0.90)	wash mode
2030-2	2.36 (0.22)	11 3/8" (289)	29 13/16" (757)	7.01 (0.65)	7.37 (0.68)	49 9/16" (1259)	11.71 (1.09)	wash mode
2036-2	2.83 (0.26)	11 3/8" (289)	35 13/16" (909)	8.45 (0.78)	8.86 (0.82)	43 9/16" (1106)	13.69 (1.27)	wash mode
2040-2	3.31 (0.31)	11 3/8" (289)	41 13/16" (1062)	9.88 (0.92)	10.34 (0.96)	37 9/16" (954)	15.67 (1.46)	wash mode
2046-2	3.78 (0.35)	11 3/8" (289)	47 13/16" (1214)	11.32 (1.05)	11.82 (1.10)	31 9/16" (802)	17.65 (1.64)	wash mode
2050-2	4.26 (0.40)	11 3/8" (289)	53 13/16" (1367)	12.76 (1.19)	13.31 (1.24)	25 9/16" (649)	19.63 (1.82)	wash mode
2056-2	4.73 (0.44)	11 3/8" (289)	59 13/16" (1519)	14.20 (1.32)	14.79 (1.37)	19 9/16" (497)	21.61 (2.01)	wash mode
2060-2	5.21 (0.48)	11 3/8" (289)	65 13/16" (1671)	15.63 (1.45)	16.27 (1.51)	13 9/16" (344)	23.59 (2.19)	wash mode
2320-2	1.78 (0.17)	14 3/8" (366)	17 13/16" (452)	4.85 (0.45)	5.15 (0.48)	61 9/16" (1564)	8.73 (0.81)	wash mode
2326-2	2.38 (0.22)	14 3/8" (366)	23 13/16" (605)	6.54 (0.61)	6.88 (0.64)	55 9/16" (1411)	10.96 (1.02)	wash mode
2330-2	2.98 (0.28)	14 3/8" (366)	29 13/16" (757)	8.23 (0.76)	8.61 (0.80)	49 9/16" (1259)	13.19 (1.23)	wash mode
2336-2	3.58 (0.33)	14 3/8" (366)	35 13/16" (909)	9.91 (0.92)	10.35 (0.96)	43 9/16" (1106)	15.42 (1.43)	wash mode
2340-2	4.18 (0.39)	14 3/8" (366)	41 13/16" (1062)	11.60 (1.08)	12.08 (1.12)	37 9/16" (954)	17.65 (1.64)	wash mode
2346-2	4.78 (0.44)	14 3/8" (366)	47 13/16" (1214)	13.29 (1.23)	13.81 (1.28)	31 9/16" (802)	19.88 (1.85)	wash mode
2350-2	5.38 (0.50)	14 3/8" (366)	53 13/16" (1367)	14.98 (1.39)	15.55 (1.44)	25 9/16" (649)	22.11 (2.05)	wash mode
2356-2	5.98 (0.56)	14 3/8" (366)	59 13/16" (1519)	16.66 (1.55)	17.28 (1.61)	19 9/16" (497)	24.34 (2.26)	wash mode
2360-2	6.58 (0.61)	14 3/8" (366)	65 13/16" (1671)	18.35 (1.70)	19.02 (1.77)	13 9/16" (344)	26.56 (2.47)	wash mode
2620-2	2.15 (0.20)	17 3/8" (442)	17 13/16" (452)	5.57 (0.52)	5.89 (0.55)	61 9/16" (1564)	9.71 (0.90)	wash mode
2626-2	2.88 (0.27)	17 3/8" (442)	23 13/16" (605)	7.51 (0.70)	7.87 (0.73)	55 9/16" (1411)	12.19 (1.13)	wash mode
2630-2	3.60 (0.33)	17 3/8" (442)	29 13/16" (757)	9.45 (0.88)	9.86 (0.92)	49 9/16" (1259)	14.67 (1.36)	wash mode
2636-2	4.33 (0.40)	17 3/8" (442)	35 13/16" (909)	11.38 (1.06)	11.84 (1.10)	43 9/16" (1106)	17.15 (1.59)	wash mode
2640-2 ◊	6.30 (0.59)	21 11/16" (551)	41 13/16" (1062)	13.32 (1.24)	13.82 (1.28)	37 9/16" (954)	19.63 (1.82)	widest clear opening
2646-2 ◊	7.21 (0.67)	21 11/16" (551)	47 13/16" (1214)	15.26 (1.42)	15.81 (1.47)	31 9/16" (802)	22.11 (2.05)	widest clear opening
2650-2 ◊	8.11 (0.75)	21 11/16" (551)	53 13/16" (1367)	17.20 (1.60)	17.79 (1.65)	25 9/16" (649)	24.59 (2.28)	widest clear opening
2656-2 ◊	9.02 (0.84)	21 11/16" (551)	59 13/16" (1519)	19.13 (1.78)	19.77 (1.84)	19 9/16" (497)	27.06 (2.51)	widest clear opening
2660-2 ◊	9.92 (0.92)	21 11/16" (551)	65 13/16" (1671)	21.07 (1.96)	21.76 (2.02)	13 9/16" (344)	29.54 (2.74)	widest clear opening
2920-2	2.52 (0.23)	20 3/8" (518)	17 13/16" (452)	6.29 (0.58)	6.63 (0.62)	61 9/16" (1564)	10.69 (0.99)	wash mode
2926-2	3.37 (0.31)	20 3/8" (518)	23 13/16" (605)	8.48 (0.79)	8.86 (0.82)	55 9/16" (1411)	13.42 (1.25)	wash mode
2930-2	4.22 (0.39)	20 3/8" (518)	29 13/16" (757)	10.66 (0.99)	11.10 (1.03)	49 9/16" (1259)	16.15 (1.50)	wash mode
2936-2 ◊	6.08 (0.57)	24 1/2" (621)	35 13/16" (909)	12.85 (1.19)	13.33 (1.24)	43 9/16" (1106)	18.88 (1.75)	widest clear opening
2940-2 ◊	5.92 (0.55)	20 3/8" (518)	41 13/16" (1062)	15.04 (1.40)	15.56 (1.45)	37 9/16" (954)	21.61 (2.01)	wash mode
2946-2 ◊	6.77 (0.63)	20 3/8" (518)	47 13/16" (1214)	17.23 (1.60)	17.80 (1.65)	31 9/16" (802)	24.34 (2.26)	wash mode
2950-2 ◊	7.62 (0.71)	20 3/8" (518)	53 13/16" (1367)	19.41 (1.80)	20.03 (1.86)	25 9/16" (649)	27.06 (2.51)	wash mode
2956-2 ◊	8.47 (0.79)	20 3/8" (518)	59 13/16" (1519)	21.60 (2.01)	22.27 (2.07)	19 9/16" (497)	29.79 (2.77)	wash mode
2960-2 ◊	9.32 (0.87)	20 3/8" (518)	65 13/16" (1671)	23.79 (2.21)	24.50 (2.28)	13 9/16" (344)	32.52 (3.02)	wash mode
3020-2	2.89 (0.27)	23 3/8" (594)	17 13/16" (452)	7.01 (0.65)	7.37 (0.68)	61 9/16" (1564)	11.67 (1.08)	wash mode
3026-2	3.87 (0.36)	23 3/8" (594)	23 13/16" (605)	9.45 (0.88)	9.86 (0.92)	55 9/16" (1411)	14.65 (1.36)	wash mode
3030-2	4.84 (0.45)	23 3/8" (594)	29 13/16" (757)	11.88 (1.10)	12.34 (1.15)	49 9/16" (1259)	17.63 (1.64)	wash mode
3036-2 ◊	5.82 (0.54)	23 3/8" (594)	35 13/16" (909)	14.32 (1.33)	14.82 (1.38)	43 9/16" (1106)	20.61 (1.91)	wash mode
3040-2 ◊	6.79 (0.63)	23 3/8" (594)	41 13/16" (1062)	16.76 (1.56)	17.31 (1.61)	37 9/16" (954)	23.59 (2.19)	wash mode
3046-2 ◊	7.77 (0.72)	23 3/8" (594)	47 13/16" (1214)	19.20 (1.78)	19.79 (1.84)	31 9/16" (802)	26.56 (2.47)	wash mode
3050-2 ◊	8.74 (0.81)	23 3/8" (594)	53 13/16" (1367)	21.63 (2.01)	22.27 (2.07)	25 9/16" (649)	29.54 (2.74)	wash mode
3056-2 ◊	9.72 (0.90)	23 3/8" (594)	59 13/16" (1519)	24.07 (2.24)	24.76 (2.30)	19 9/16" (497)	32.52 (3.02)	wash mode
3060-2 ◊	10.69 (0.99)	23 3/8" (594)	65 13/16" (1671)	26.51 (2.46)	27.24 (2.53)	13 9/16" (344)	35.50 (3.30)	wash mode

*Top of Subfloor to Top of Inside Sill Stop" is calculated based upon a structural header height of 6'-10 1/2" (2096).
 • Dimensions in parentheses are in millimeters or meters squared.
 ◊Meet or exceed clear opening area of 5.7 sq.ft. or 0.53 m², clear opening width of 20" (508) and clear opening height of 24" (610).

Grille Patterns

	Prairie A	Colonial	Specified Equal Light with Simulated Meeting Rail	Modified Colonial	Tall Fractional	Short Fractional	Victorian
Casement							

Number of lights and overall pattern varies with window size. Patterns shown may not be available for all sizes. Specified equal light pattern is also available. For more information on divided light, see page 13 or visit andersenwindows.com/grilles.

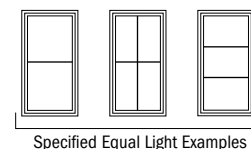

Casement Window Details – New Construction

Scale 1 1/2" (38) = 1'-0" (305) – 1:8

1 3/8" flange setback

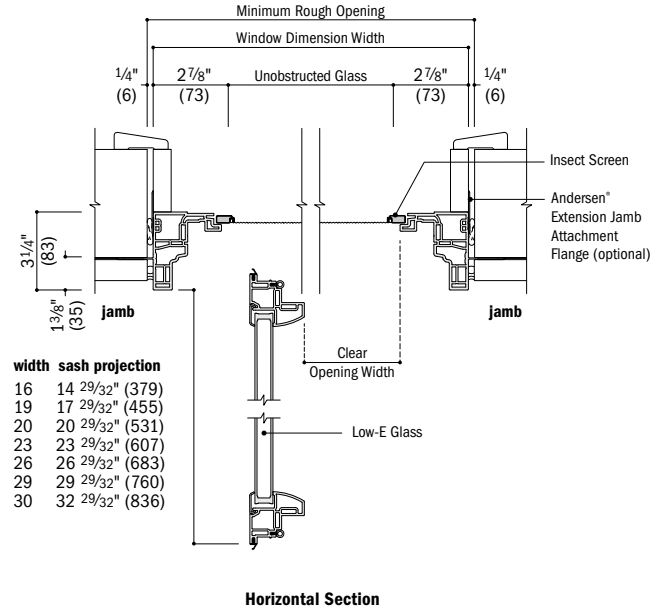
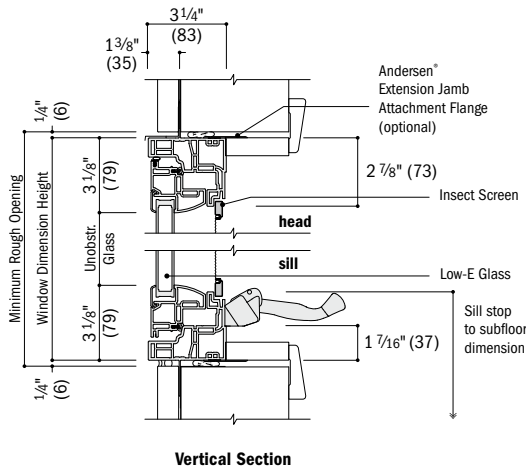

1" flange setback with stucco key

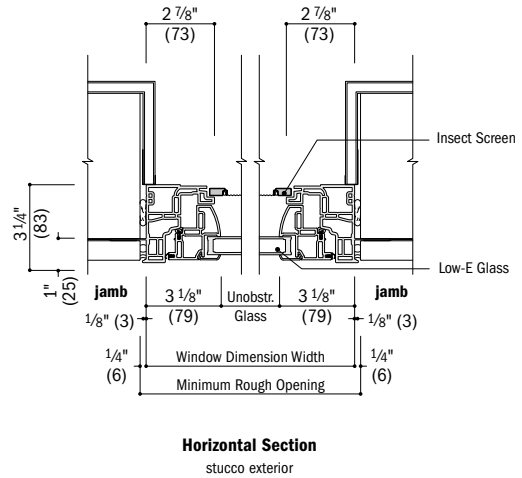
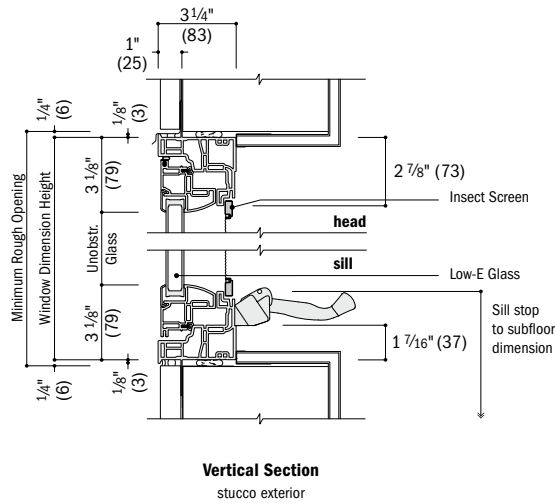

Integrals

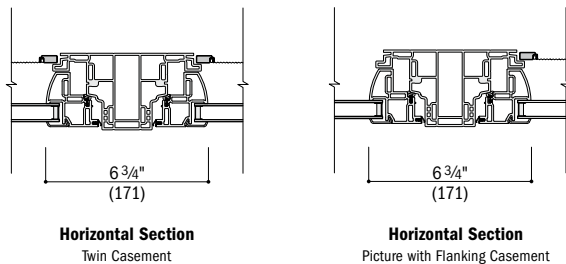

See pages 85-87 for horizontal and vertical joining details.

- Drip cap is required to complete window installation as shown, but may not be included with the window. Use of drip cap is recommended for proper installation.
- Light-colored areas are parts included with window. Dark-colored areas are additional Andersen® parts required to complete window assembly as shown.
- **Rough openings may need to be increased to allow for use of building wraps, flashing, sill panning, brackets, fasteners or other items. See installation information on page 109.**
- Details are for illustration only and are not intended to represent product installation methods or materials. Refer to product installation guides at andersenwindows.com.
- Dimensions in parentheses are in millimeters.

100 Series
Casement & Awning
Windows

CASEMENT WINDOWS

Casement Window Details - Replacement

Scale 1 1/2" (38) = 1'-0" (305) - 1:8

no flange

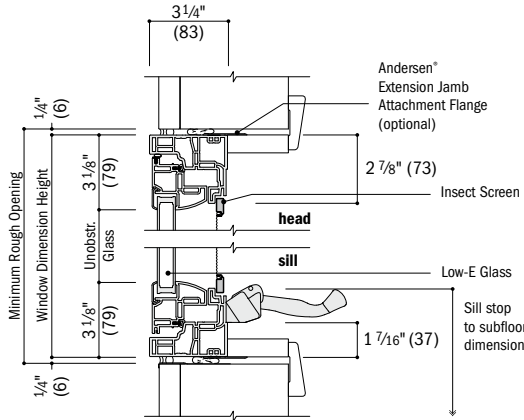

Vertical Section
existing framed opening

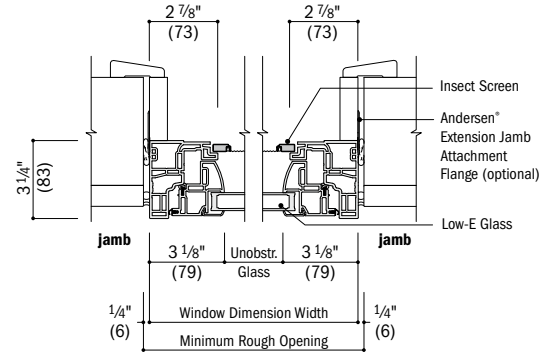

Horizontal Section
existing framed opening

insert

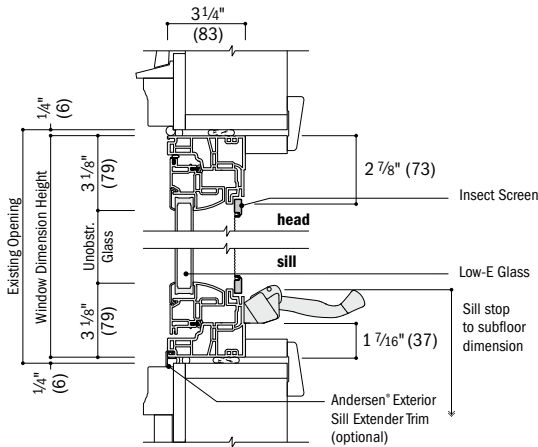

Vertical Section
existing window opening

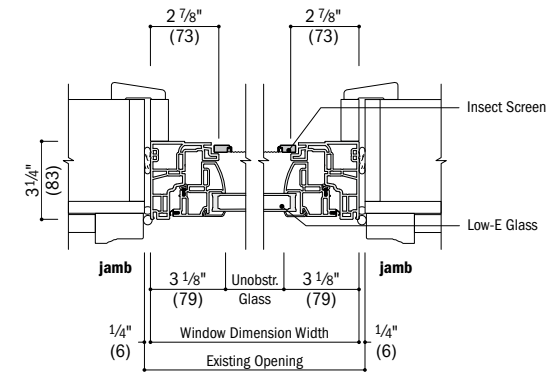

Horizontal Section
existing window opening

integrals

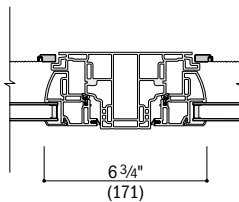

Horizontal Section
Twin Casement

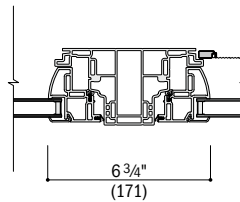

Horizontal Section
Picture with Flanking Casement

Installation accessories for insert frame shown on page 108.

See pages 85-87 for horizontal and vertical joining details.

- Drip cap is required to complete window installation as shown, but may not be included with the window. Use of drip cap is recommended for proper installation.
- Light-colored areas are parts included with window. Dark-colored areas are additional Andersen® parts required to complete window assembly as shown.
- **Rough openings may need to be increased to allow for use of building wraps, flashing, sill panning, brackets, fasteners or other items. See installation information on page 109.**
- Details are for illustration only and are not intended to represent product installation methods or materials. Refer to product installation guides at andersenwindows.com.
- Dimensions in parentheses are in millimeters.

Table of Awning Window Sizes

Scale 1/8" (3) = 1'-0" (305) – 1:96

Window Dimension	1'-5 1/2"	1'-11 1/2"	2'-5 1/2"	2'-11 1/2"	3'-5 1/2"	3'-11 1/2"
	(445)	(597)	(749)	(902)	(1054)	(1207)
Minimum Rough Opening	1'-6"	2'-0"	2'-6"	3'-0"	3'-6"	4'-0"
	(457)	(610)	(762)	(914)	(1067)	(1219)
Unobstructed Glass	11 1/4"	17 1/4"	23 1/4"	29 1/4"	35 1/4"	41 1/4"
	(286)	(438)	(591)	(743)	(895)	(1048)

CUSTOM WIDTHS – 17 1/2" to 47 1/2"

CUSTOM HEIGHTS – 17 1/2" to 35 1/2"	CUSTOM WIDTHS – 17 1/2" to 47 1/2"					
	1'-5 1/2"	1'-11 1/2"	2'-5 1/2"	2'-11 1/2"	3'-5 1/2"	3'-11 1/2"
1'-5 1/2"	1616	2016	2616	3016	3616	4016
1'-11 1/2"	1620	2020	2620	3020	3620	4020
2'-5 1/2"	1626	2026	2626	3026	3626	4026
2'-11 1/2"	1630	2030	2630	3030	3630	4030



Custom-size windows are available in 1/8" (3) increments. See page 88 for custom sizes and specifications.

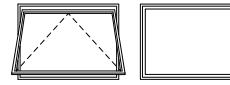

Venting Stationary

Choose venting or stationary. **Awning windows must be installed to vent as shown and should not be rotated and used as a hopper.** Details shown on pages 28-29. Grille patterns shown on page 26.

Table of Twin Awning Window Sizes

Scale 1/8" (3) = 1'-0" (305) – 1:96

Window Dimension	2'-11 1/2"	3'-5 1/2"	3'-11 1/2"	4'-5 1/2"	4'-11 1/2"	5'-5 1/2"	5'-11 1/2"
	(902)	(1054)	(1207)	(1359)	(1511)	(1664)	(1816)
Minimum Rough Opening	3'-0"	3'-6"	4'-0"	4'-6"	5'-0"	5'-6"	6'-0"
	(914)	(1067)	(1219)	(1372)	(1524)	(1676)	(1829)
Unobstructed Glass (width of single sash)	11 1/4"	14 1/4"	17 1/4"	20 1/4"	23 1/4"	26 1/4"	29 1/4"
	(286)	(362)	(438)	(514)	(591)	(667)	(743)

CUSTOM HEIGHTS – 17 1/2" to 35 1/2"	CUSTOM WIDTHS – 35 1/2" to 71 1/2"						
	2'-11 1/2"	3'-5 1/2"	3'-11 1/2"	4'-5 1/2"	4'-11 1/2"	5'-5 1/2"	5'-11 1/2"
11 1/2"	1610-2	1910-2	2010-2	2310-2	2610-2	2910-2	3010-2
1'-5 1/2"	1616-2	1916-2	2016-2	2316-2	2616-2	2916-2	3016-2
1'-11 1/2"	1620-2	1920-2	2020-2	2320-2	2620-2	2920-2	3020-2

CUSTOM HEIGHTS – 17 1/2" to 35 1/2"	CUSTOM WIDTHS – 35 1/2" to 71 1/2"						
	2'-11 1/2"	3'-5 1/2"	3'-11 1/2"	4'-5 1/2"	4'-11 1/2"	5'-5 1/2"	5'-11 1/2"
1'-5 1/2"	1616-2	1916-2	2016-2	2316-2	2616-2	2916-2	3016-2
1'-11 1/2"	1620-2	1920-2	2020-2	2320-2	2620-2	2920-2	3020-2
2'-5 1/2"	1626-2	1926-2	2026-2	2326-2	2626-2	2926-2	3026-2
2'-11 1/2"	1630-2	1930-2	2030-2	2330-2	2630-2	2930-2	3030-2



Custom-size windows are available in 1/8" (3) increments. See page 88 for custom sizes and specifications.

Windows have one continuous outer frame.

Twin transoms are also shown. See pages 70-71 for more information.

Details shown on pages 28-29. Grille patterns shown on page 26.

• "Window Dimension" always refers to outside frame to frame dimension.
 • "Minimum Rough Opening" dimensions may need to be increased to allow for use of building wraps, flashing, sill panning, brackets, fasteners or other items. See page 109 for more details.
 • Dimensions in parentheses are in millimeters.

AWNING WINDOWS

Table of Sizes for Picture Window over Awning

Scale 1/8" (3) = 1'-0" (305) – 1:96

Window Dimension	1'-11 1/2" (597)	2'-5 1/2" (749)	2'-11 1/2" (902)	3'-5 1/2" (1054)	3'-11 1/2" (1207)
Minimum Rough Opening	2'-0" (610)	2'-6" (762)	3'-0" (914)	3'-6" (1067)	4'-0" (1219)
Unobstructed Glass (height of upper sash)	17 1/4" (438)	23 1/4" (591)	29 1/4" (743)	35 1/4" (895)	41 1/4" (1048)

Window Dimension	CUSTOM WIDTHS – 17 1/2" to 47 1/2"				
	17 1/2"	23 1/4"	29 1/4"	35 1/4"	41 1/4"
3'-11 1/2" (1207)	2020 2020	2620 2620	3020 3020	3620 3620	4020 4020
4'-11 1/2" (1511)	2026 2026	2626 2626	3026 3026	3626 3626	4026 4026
5'-11 1/2" (1816)	2030 2030	2630 2630	3030 3030	3630 3630	4030 4030
5'-11 1/2" (1816)	2040 2020	2640 2620	3040 3020	3640 3620	4040 4020
6'-11 1/2" (2121)	2040 2030	2640 2630	3040 3030	3640 3630	4040 4030
6'-11 1/2" (2121)	2050 2020	2650 2620	3050 3020	3650 3620	4050 4020
7'-11 1/2" (2426)	2050 2030	2650 2630	3050 3030	3650 3630	4050 4030



Custom-size windows are available in 1/8" (3) increments. See page 89 for custom sizes and specifications.

Windows have one continuous outer frame.

For unobstructed glass height dimensions of lower sash, see page 25.

Details shown on pages 28-29.

Grille patterns shown below.

Grille Patterns

	Prairie A	Colonial	Modified Colonial*
Awning			
	Tall Fractional	Short Fractional	Victorian

*Modified colonial pattern is available only for the upper sash of a picture window over awning configuration.

Number of lights and overall pattern varies with window size. Patterns shown may not be available for all sizes. Specified equal light pattern is also available. For more information on divided light, see page 13 or visit andersenwindows.com/grilles.

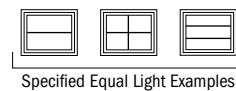

Specified Equal Light Examples

• "Window Dimension" always refers to outside frame to frame dimension.
 • "Minimum Rough Opening" dimensions may need to be increased to allow for use of building wraps, flashing, sill panning, brackets, fasteners or other items. See page 109 for more details.
 • Dimensions in parentheses are in millimeters.

Awning Window Opening and Area Specifications

Window Number	Clear Opening Area Sq. Ft./ (m ²)	Clear Opening in Full Open Position		Glass Area Sq. Ft./ (m ²)	Vent Area Sq. Ft./ (m ²)	Top of Subfloor to Top of Inside Sill Stop Inches/ (mm)	Overall Window Area Sq. Ft./ (m ²)
		Width Inches/ (mm)	Depth Inches/ (mm)				
1616	0.66 (0.06)	11 13/16" (300)	8" (203)	0.88 (0.08)	0.66 (0.06)	67 9/16" (1716)	2.13 (0.20)
1620	0.66 (0.06)	11 13/16" (300)	8" (203)	1.35 (0.13)	0.66 (0.06)	61 9/16" (1564)	2.86 (0.27)
1626	0.66 (0.06)	11 13/16" (300)	8" (203)	1.82 (0.17)	0.66 (0.06)	55 9/16" (1411)	3.59 (0.33)
1630	0.66 (0.06)	11 13/16" (300)	8" (203)	2.29 (0.21)	0.66 (0.06)	49 9/16" (1259)	4.31 (0.40)
2016	0.99 (0.09)	17 13/16" (452)	8" (203)	1.35 (0.13)	0.99 (0.09)	67 9/16" (1716)	2.86 (0.27)
2020	0.99 (0.09)	17 13/16" (452)	8" (203)	2.07 (0.19)	0.99 (0.09)	61 9/16" (1564)	3.84 (0.36)
2026	0.99 (0.09)	17 13/16" (452)	8" (203)	2.79 (0.26)	0.99 (0.09)	55 9/16" (1411)	4.81 (0.45)
2030	0.99 (0.09)	17 13/16" (452)	8" (203)	3.50 (0.33)	0.99 (0.09)	49 9/16" (1259)	5.79 (0.54)
2616	1.32 (0.12)	23 13/16" (605)	8" (203)	1.82 (0.17)	1.32 (0.12)	67 9/16" (1716)	3.59 (0.33)
2620	1.32 (0.12)	23 13/16" (605)	8" (203)	2.79 (0.26)	1.32 (0.12)	61 9/16" (1564)	4.81 (0.45)
2626	1.32 (0.12)	23 13/16" (605)	8" (203)	3.75 (0.35)	1.32 (0.12)	55 9/16" (1411)	6.04 (0.56)
2630	1.32 (0.12)	23 13/16" (605)	8" (203)	4.72 (0.44)	1.32 (0.12)	49 9/16" (1259)	7.27 (0.68)
3016	1.66 (0.15)	29 13/16" (757)	8" (203)	2.29 (0.21)	1.66 (0.15)	67 9/16" (1716)	4.31 (0.40)
3020	1.66 (0.15)	29 13/16" (757)	8" (203)	3.50 (0.33)	1.66 (0.15)	61 9/16" (1564)	5.79 (0.54)
3026	1.66 (0.15)	29 13/16" (757)	8" (203)	4.72 (0.44)	1.66 (0.15)	55 9/16" (1411)	7.27 (0.68)
3030	1.66 (0.15)	29 13/16" (757)	8" (203)	5.94 (0.55)	1.66 (0.15)	49 9/16" (1259)	8.75 (0.81)
3616	1.99 (0.18)	35 13/16" (909)	8" (203)	2.75 (0.26)	1.99 (0.18)	67 9/16" (1716)	5.04 (0.47)
3620	1.99 (0.18)	35 13/16" (909)	8" (203)	4.22 (0.39)	1.99 (0.18)	61 9/16" (1564)	6.77 (0.63)
3626	1.99 (0.18)	35 13/16" (909)	8" (203)	5.69 (0.53)	1.99 (0.18)	55 9/16" (1411)	8.50 (0.79)
3630	1.99 (0.18)	35 13/16" (909)	8" (203)	7.16 (0.67)	1.99 (0.18)	49 9/16" (1259)	10.23 (0.95)
4016	2.32 (0.22)	41 13/16" (1062)	8" (203)	3.22 (0.30)	2.32 (0.22)	67 9/16" (1716)	5.77 (0.54)
4020	2.32 (0.22)	41 13/16" (1062)	8" (203)	4.94 (0.46)	2.32 (0.22)	61 9/16" (1564)	7.75 (0.72)
4026	2.32 (0.22)	41 13/16" (1062)	8" (203)	6.66 (0.62)	2.32 (0.22)	55 9/16" (1411)	9.73 (0.90)
4030	2.32 (0.22)	41 13/16" (1062)	8" (203)	8.38 (0.78)	2.32 (0.22)	49 9/16" (1259)	11.71 (1.09)

Twin Awning Window Opening and Area Specifications

Window Number	Clear Opening Area Sq. Ft./ (m ²)	Clear Opening in Full Open Position		Glass Area Sq. Ft./ (m ²)	Vent Area Sq. Ft./ (m ²)	Top of Subfloor to Top of Inside Sill Stop Inches/ (mm)	Overall Window Area Sq. Ft./ (m ²)
		Width Inches/ (mm)	Depth Inches/ (mm)				
1616-2	0.66 (0.06)	11 13/16" (300)	8" (203)	1.76 (0.16)	1.31 (0.12)	67 9/16" (1716)	4.31 (0.40)
1620-2	0.66 (0.06)	11 13/16" (300)	8" (203)	2.70 (0.25)	1.31 (0.12)	61 9/16" (1564)	5.79 (0.54)
1626-2	0.66 (0.06)	11 13/16" (300)	8" (203)	3.63 (0.34)	1.31 (0.12)	55 9/16" (1411)	7.27 (0.68)
1630-2	0.66 (0.06)	11 13/16" (300)	8" (203)	4.57 (0.42)	1.31 (0.12)	49 9/16" (1259)	8.75 (0.81)
1916-2	0.82 (0.08)	14 13/16" (376)	8" (203)	2.23 (0.21)	1.65 (0.15)	67 9/16" (1716)	5.04 (0.47)
1920-2	0.82 (0.08)	14 13/16" (376)	8" (203)	3.41 (0.32)	1.65 (0.15)	61 9/16" (1564)	6.77 (0.63)
1926-2	0.82 (0.08)	14 13/16" (376)	8" (203)	4.60 (0.43)	1.65 (0.15)	55 9/16" (1411)	8.50 (0.79)
1930-2	0.82 (0.08)	14 13/16" (376)	8" (203)	5.79 (0.54)	1.65 (0.15)	49 9/16" (1259)	10.23 (0.95)
2016-2	0.99 (0.09)	17 13/16" (452)	8" (203)	2.70 (0.25)	1.98 (0.18)	67 9/16" (1716)	5.77 (0.54)
2020-2	0.99 (0.09)	17 13/16" (452)	8" (203)	4.13 (0.38)	1.98 (0.18)	61 9/16" (1564)	7.75 (0.72)
2026-2	0.99 (0.09)	17 13/16" (452)	8" (203)	5.57 (0.52)	1.98 (0.18)	55 9/16" (1411)	9.73 (0.90)
2030-2	0.99 (0.09)	17 13/16" (452)	8" (203)	7.01 (0.65)	1.98 (0.18)	49 9/16" (1259)	11.71 (1.09)
2316-2	1.16 (0.11)	20 13/16" (528)	8" (203)	3.16 (0.29)	2.31 (0.21)	67 9/16" (1716)	6.50 (0.60)
2320-2	1.16 (0.11)	20 13/16" (528)	8" (203)	4.85 (0.45)	2.31 (0.21)	61 9/16" (1564)	8.73 (0.81)
2326-2	1.16 (0.11)	20 13/16" (528)	8" (203)	6.54 (0.61)	2.31 (0.21)	55 9/16" (1411)	10.96 (1.02)
2330-2	1.16 (0.11)	20 13/16" (528)	8" (203)	8.23 (0.76)	2.31 (0.21)	49 9/16" (1259)	13.19 (1.23)
2616-2	1.32 (0.12)	23 13/16" (605)	8" (203)	3.63 (0.34)	2.65 (0.25)	67 9/16" (1716)	7.23 (0.67)
2620-2	1.32 (0.12)	23 13/16" (605)	8" (203)	5.57 (0.52)	2.65 (0.25)	61 9/16" (1564)	9.71 (0.90)
2626-2	1.32 (0.12)	23 13/16" (605)	8" (203)	7.51 (0.70)	2.65 (0.25)	55 9/16" (1411)	12.19 (1.13)
2630-2	1.32 (0.12)	23 13/16" (605)	8" (203)	9.45 (0.88)	2.65 (0.25)	49 9/16" (1259)	14.67 (1.36)
2916-2	1.49 (0.14)	26 13/16" (681)	8" (203)	4.10 (0.38)	2.98 (0.28)	67 9/16" (1716)	7.96 (0.74)
2920-2	1.49 (0.14)	26 13/16" (681)	8" (203)	6.29 (0.58)	2.98 (0.28)	61 9/16" (1564)	10.69 (0.99)
2926-2	1.49 (0.14)	26 13/16" (681)	8" (203)	8.48 (0.79)	2.98 (0.28)	55 9/16" (1411)	13.42 (1.25)
2930-2	1.49 (0.14)	26 13/16" (681)	8" (203)	10.66 (0.99)	2.98 (0.28)	49 9/16" (1259)	16.15 (1.50)
3016-2	1.66 (0.15)	29 13/16" (757)	8" (203)	4.57 (0.42)	3.31 (0.31)	67 9/16" (1716)	8.69 (0.81)
3020-2	1.66 (0.15)	29 13/16" (757)	8" (203)	7.01 (0.65)	3.31 (0.31)	61 9/16" (1564)	11.67 (1.08)
3026-2	1.66 (0.15)	29 13/16" (757)	8" (203)	9.45 (0.88)	3.31 (0.31)	55 9/16" (1411)	14.65 (1.36)
3030-2	1.66 (0.15)	29 13/16" (757)	8" (203)	11.88 (1.10)	3.31 (0.31)	49 9/16" (1259)	17.63 (1.64)

• "Top of Subfloor to Top of Inside Sill Stop" is calculated based upon a structural header height of 6'-10 1/2" (2096).
• Dimensions in parentheses are in millimeters or meters squared.

AWNING WINDOWS

Awning Window Details – New Construction

Scale 1 1/2" (38) = 1'-0" (305) – 1:8

1 3/8" flange setback

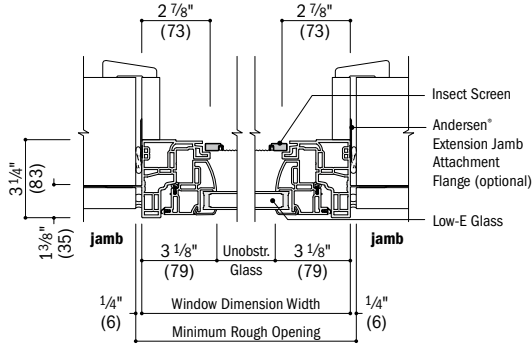

Horizontal Section

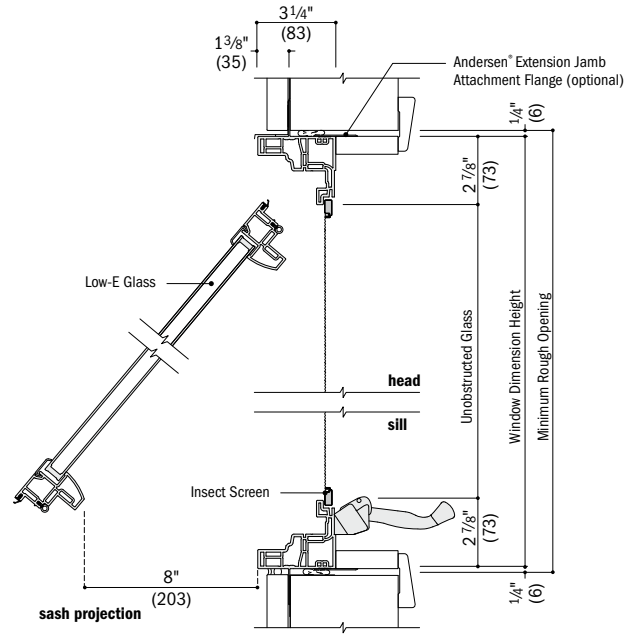

Vertical Section

1" flange setback with stucco key

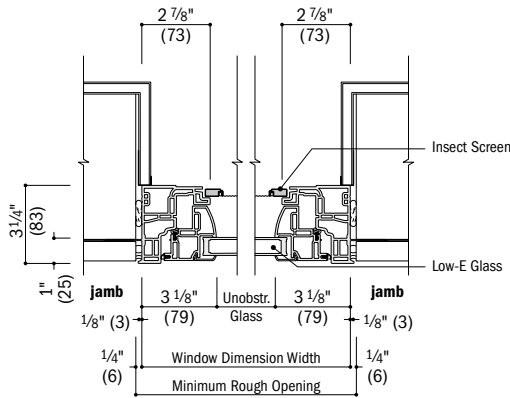

Horizontal Section
stucco exterior

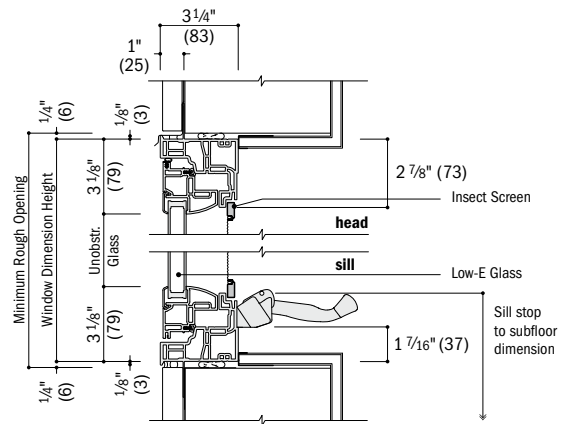

Vertical Section
stucco exterior

Integrals

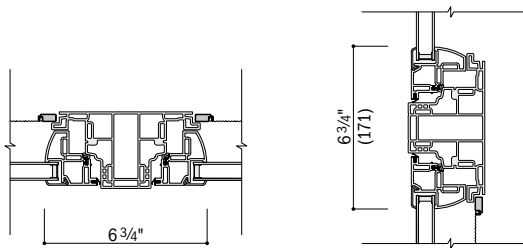

Horizontal Section
Twin Casement

Vertical Section
Picture over Awning

See pages 84-87 for horizontal and vertical joining details.

- Drip cap is required to complete window installation as shown, but may not be included with the window. Use of drip cap is recommended for proper installation.
- Light-colored areas are parts included with window. Dark-colored areas are additional Andersen® parts required to complete window assembly as shown.
- **Rough openings may need to be increased to allow for use of building wraps, flashing, sill panning, brackets, fasteners or other items. See installation information on page 109.**
- Details are for illustration only and are not intended to represent product installation methods or materials. Refer to product installation guides at andersenwindows.com.
- Dimensions in parentheses are in millimeters.

Awning Window Details - Replacement

Scale 1 1/2" (38) = 1'-0" (305) - 1:8

no flange

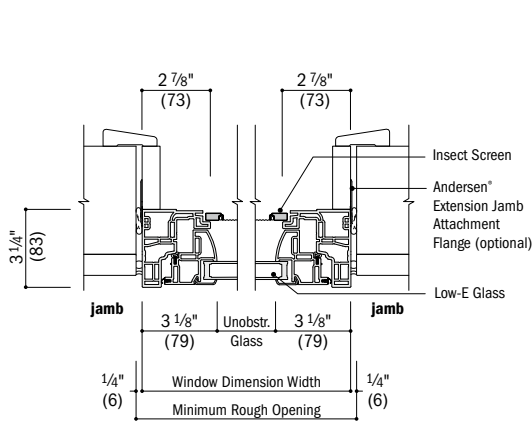

Horizontal Section
existing framed opening

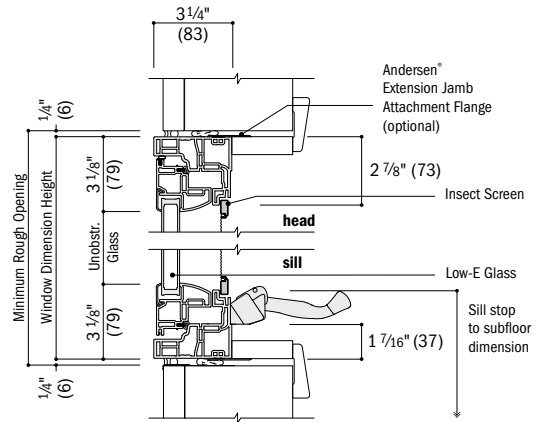

Vertical Section
existing framed opening

insert

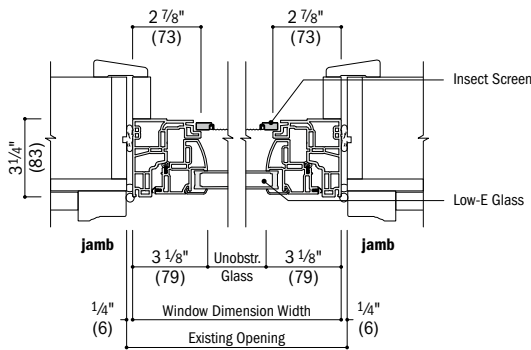

Horizontal Section
existing window opening

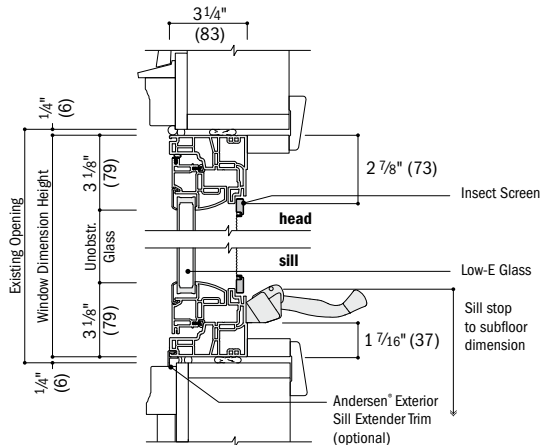

Vertical Section
existing window opening

integrals

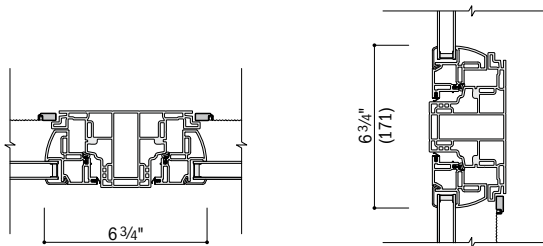

Horizontal Section
Twin Casement

Vertical Section
Picture over Awning

Installation accessories for insert frame shown on page 108.

See pages 84-87 for horizontal and vertical joining details.

100 Series
Casement & Awning
Windows

- Drip cap is required to complete window installation as shown, but may not be included with the window. Use of drip cap is recommended for proper installation.
- Light-colored areas are parts included with window. Dark-colored areas are additional Andersen[®] parts required to complete window assembly as shown.
- **Rough openings may need to be increased to allow for use of building wraps, flashing, sill panning, brackets, fasteners or other items. See installation information on page 109.**
- Details are for illustration only and are not intended to represent product installation methods or materials. Refer to product installation guides at andersenwindows.com.
- Dimensions in parentheses are in millimeters.

SINGLE-HUNG WINDOWS

Table of Arch Single-Hung Window Sizes

Scale 1/8" (3) = 1'-0" (305) – 1:96

Window Width Dimension	1'-11 1/2"	2'-5 1/2"	2'-11 1/2"	3'-5 1/2"
Minimum Rough Opening	(597) 2'-0" (610)	(749) 2'-6" (762)	(902) 3'-0" (914)	(1054) 3'-6" (1067)
Unobstructed Glass (width of upper sash)	20"	26"	32"	38"
Unobstructed Glass (width of lower sash)	17 1/4" (438)	23 1/4" (591)	29 1/4" (743)	35 1/4" (895)
Radius	23 1/2" (597)	29 1/2" (749)	35 1/2" (902)	41 1/2" (1054)
Unobstructed Glass Chord Height (height of lower sash shown below)	3 1/8" (79)	4" (102)	4 3/4" (121)	5 1/2" (140)
Unobstructed Glass (height of upper sash shown to right of window)	15 1/16" (383)	15 7/8" (403)	16 11/16" (424)	17 1/2" (445)
Side Height	2'-5 1/2" (749)	2'-9 1/2" (851)	2'-10 1/4" (870)	2'-11" (889)
Window Height (shown left of window)	2'-8 5/8" (829)	2'-9 1/2" (851)	2'-10 1/4" (870)	2'-11" (889)
10 9/16" (268)	2026	2626	3026	3626
13 9/16" (345)	2030	2630	3030	3630
16 9/16" (421)	2036	2636	3036	3636
19 9/16" (497)	2040	2640	3040	3640
22 9/16" (573)	2046	2646	3046	3646
25 9/16" (649)	2050	2650	3050 ^o	3650 ^o
28 9/16" (726)	2056	2656	3056 ^o	3656 ^o
31 9/16" (802)	2060	2660 ^o	3060 ^o	3660 ^o
34 9/16" (878)	2066	2666 ^o	3066 ^o	3666 ^o



Custom-size windows

are available in 1/8" (3) increments. Contact your Andersen supplier for more information.

For arch single-hung windows, the size designation does not reflect the overall window height. (e.g., a 2026 window size has a side height of 2'-5 1/2" and an overall window height of 2'-8 5/8".)

Height dimensions for upper sash are to the right of each window size and lower sash are to the far left.

Details are shown on pages 48-51. Grille patterns shown on page 47.

continued on next page

* "Window Dimension" always refers to outside frame to frame dimension.
 • "Minimum Rough Opening" dimensions may need to be increased to allow for use of building wraps, flashing, sill panning, brackets, fasteners or other items. See page 109 for more details.
 • Dimensions in parentheses are in millimeters.
^o Meet or exceed clear opening area of 5.7 sq.ft. or 0.53 m², clear opening width of 20" (508) and clear opening height of 24" (610). See table on pages 31 and 33.

Table of Arch Single-Hung Window Sizes (continued)

Scale 1/8" (3) = 1'-0" (305) – 1:96

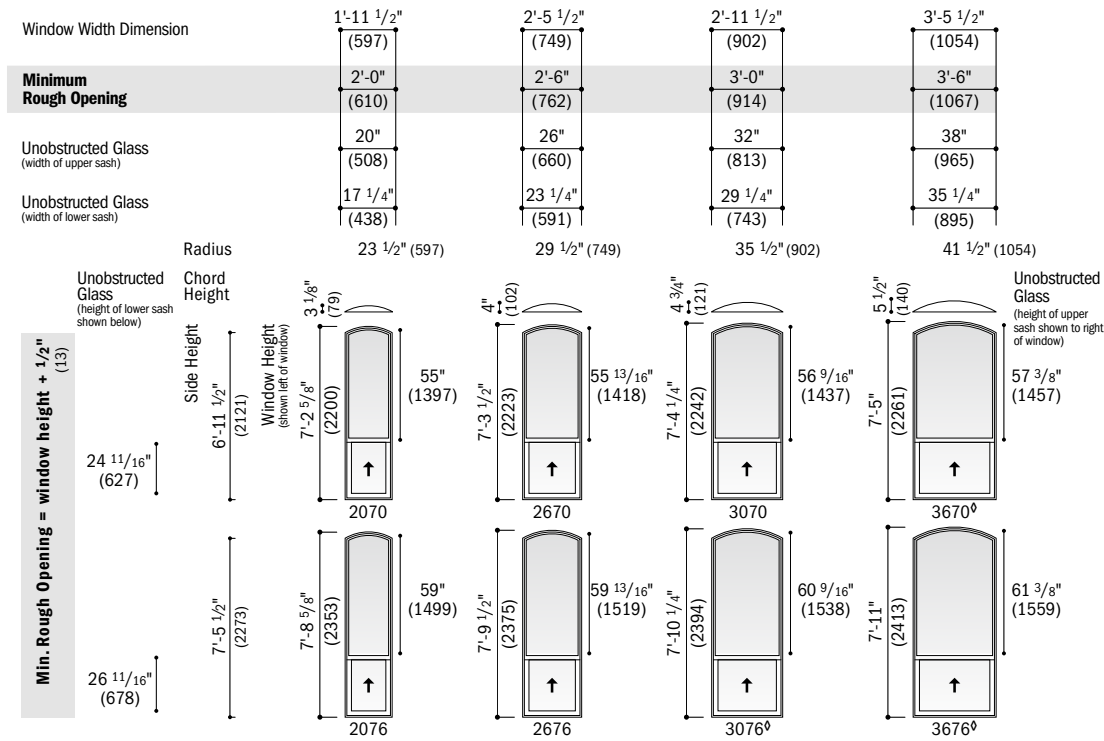

For arch single-hung windows, the size designation does not reflect the overall window height.

Height dimensions for upper sash are to the right of each window size and lower sash are to the far left.

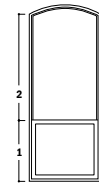

Windows with a side height greater than 6'-5 1/2" (1969) are only available with a 2:1 reverse cottage sash ratio.

Details are shown on pages 48-51.

Grille patterns shown on page 47.

- *"Window Dimension" always refers to outside frame to frame dimension.
- *"Minimum Rough Opening" dimensions may need to be increased to allow for use of building wraps, flashing, sill panning, brackets, fasteners or other items. See page 109 for more details.
- Dimensions in parentheses are in millimeters.
- ◊Meet or exceed clear opening area of 5.7 sq.ft. or 0.53 m², clear opening width of 20" (508) and clear opening height of 24" (610). See table on pages 31 and 33.
- *For side heights greater than 6'-5 1/2" (1969), meeting rail location = (side height in inches x 0.33) + 1.96".

Arch Single-Hung Window Opening and Area Specifications

Window Number	Clear Opening Area Sq. Ft./ (m ²)	Clear Opening in Full Open Position		Glass Area Sq. Ft./ (m ²)	Vent Area Sq. Ft./ (m ²)	Top of Subfloor to Top of Inside Sill Stop Inches/ (mm)	Overall Window Area Sq. Ft./ (m ²)
		Width Inches/ (mm)	Height Inches/ (mm)				
2026	1.53 (0.14)	20" (508)	11 1/16" (280)	3.25 (0.30)	1.53 (0.14)	51 3/8" (1304)	5.16 (0.48)
2030	1.95 (0.18)	20" (508)	14 1/16" (357)	4.03 (0.37)	1.95 (0.18)	45 3/8" (1152)	6.14 (0.57)
2036	2.37 (0.22)	20" (508)	17 1/16" (433)	4.80 (0.45)	2.37 (0.22)	39 3/8" (1000)	7.12 (0.66)
2040	2.78 (0.26)	20" (508)	20 1/16" (509)	5.58 (0.52)	2.78 (0.26)	33 3/8" (847)	8.10 (0.75)
2046	3.20 (0.30)	20" (508)	23 1/16" (585)	6.36 (0.59)	3.20 (0.30)	27 3/8" (695)	9.08 (0.84)
2050	3.62 (0.34)	20" (508)	26 1/16" (661)	7.13 (0.66)	3.62 (0.34)	21 3/8" (542)	10.06 (0.93)
2056	4.03 (0.37)	20" (508)	29 1/16" (738)	7.91 (0.73)	4.03 (0.37)	15 3/8" (390)	11.04 (1.03)
2060	4.45 (0.41)	20" (508)	32 1/16" (814)	8.68 (0.81)	4.45 (0.41)	9 3/8" (238)	12.02 (1.12)
2066	4.87 (0.45)	20" (508)	35 1/16" (890)	9.46 (0.88)	4.87 (0.45)	-	12.99 (1.21)
2070	3.48 (0.32)	20" (508)	25 1/16" (636)	10.48 (0.97)	3.48 (0.32)	-	13.97 (1.30)
2076	3.76 (0.35)	20" (508)	27 1/16" (687)	11.28 (1.05)	3.76 (0.35)	-	14.95 (1.39)
2626	1.99 (0.19)	26" (660)	11 1/16" (280)	4.39 (0.41)	1.99 (0.19)	50 9/16" (1284)	6.59 (0.61)
2630	2.53 (0.24)	26" (660)	14 1/16" (357)	5.41 (0.50)	2.53 (0.24)	44 9/16" (1132)	7.82 (0.73)
2636	3.08 (0.29)	26" (660)	17 1/16" (433)	6.44 (0.60)	3.08 (0.29)	38 9/16" (979)	9.05 (0.84)
2640	3.62 (0.34)	26" (660)	20 1/16" (509)	7.46 (0.69)	3.62 (0.34)	32 9/16" (827)	10.28 (0.95)
2646	4.16 (0.39)	26" (660)	23 1/16" (585)	8.49 (0.79)	4.16 (0.39)	26 9/16" (674)	11.51 (1.07)
2650	4.70 (0.44)	26" (660)	26 1/16" (661)	9.52 (0.88)	4.70 (0.44)	20 9/16" (522)	12.74 (1.18)
2656	5.24 (0.49)	26" (660)	29 1/16" (738)	10.54 (0.98)	5.24 (0.49)	14 9/16" (370)	13.97 (1.30)
2660 ◊	5.78 (0.54)	26" (660)	32 1/16" (814)	11.57 (1.07)	5.78 (0.54)	8 9/16" (217)	15.20 (1.41)
2666 ◊	6.33 (0.59)	26" (660)	35 1/16" (890)	12.59 (1.17)	6.33 (0.59)	-	16.42 (1.53)
2670	4.52 (0.42)	26" (660)	25 1/16" (636)	13.87 (1.29)	4.52 (0.42)	-	17.65 (1.64)
2676	4.88 (0.45)	26" (660)	27 1/16" (687)	14.91 (1.39)	4.88 (0.45)	-	18.88 (1.75)
3026	2.45 (0.23)	32" (813)	11 1/16" (280)	5.57 (0.52)	2.45 (0.23)	49 3/4" (1263)	8.07 (0.75)
3030	3.12 (0.29)	32" (813)	14 1/16" (357)	6.84 (0.64)	3.12 (0.29)	43 3/4" (1111)	9.54 (0.89)

- *"Top of Subfloor to Top of Inside Sill Stop" is calculated based upon a structural header height of 6'-10 1/2" (2096).
- Dimensions in parentheses are in millimeters or square meters.
- ◊Meet or exceed clear opening area of 5.7 sq. ft. or 0.53 m², clear opening width of 20" (508) and clear opening height of 24" (610).

continued on page 33

SINGLE-HUNG WINDOWS

Table of Single-Hung Window Sizes

Scale 1/8" (3) = 1'-0" (305) – 1:96

Window Dimension	1'-5 1/2"	1'-11 1/2"	2'-5 1/2"	2'-11 1/2"	3'-5 1/2"	3'-11 1/2"
Minimum Rough Opening	1'-6"	2'-0"	2'-6"	3'-0"	3'-6"	4'-0"
Unobstructed Glass (height of single sash)	11 1/4"	17 1/4"	23 1/4"	29 1/4"	35 1/4"	41 1/4"
	(445)	(597)	(749)	(902)	(1054)	(1207)
	(457)	(610)	(762)	(914)	(1067)	(1219)
	(286)	(438)	(591)	(743)	(895)	(1048)

CUSTOM HEIGHTS – 23 1/2" to 77 1/2"	CUSTOM WIDTHS – 17 1/2" to 47 1/2"					
	1'-5 1/2"	1'-11 1/2"	2'-5 1/2"	2'-11 1/2"	3'-5 1/2"	3'-11 1/2"
1'-11 1/2"	1620	2020	2620	3020	3620	4020
2'-5 1/2"	1626	2026	2626	3026	3626	4026
2'-11 1/2"	1630	2030	2630	3030	3630	4030
3'-5 1/2"	1636	2036	2636	3036	3636	4036
3'-11 1/2"	1640	2040	2640	3040	3640	4040
4'-5 1/2"	1646	2046	2646	3046	3646	4046
4'-11 1/2"	1650	2050	2650†	3050†	3650†	4050†
5'-5 1/2"	1656	2056	2656†	3056†	3656†	4056†
5'-11 1/2"	1660	2060	2660†	3060†	3660†	4060†
6'-5 1/2"	1666	2066	2666†	3066†	3666†	4066†
6'-11 1/2"	1670	2070	2670†	3070†	3670†	4070†

Reverse cottage sash is available based on a 3:2 ratio. Available in standard widths for the heights shown below.

REVERSE COTTAGE CUSTOM WIDTHS – 1'-5 1/2" (445) to 3'-11 1/2" (1207)

REVERSE COTTAGE CUSTOM HEIGHTS – 2'-5 1/2" (749) to 6'-5 1/2" (1969)

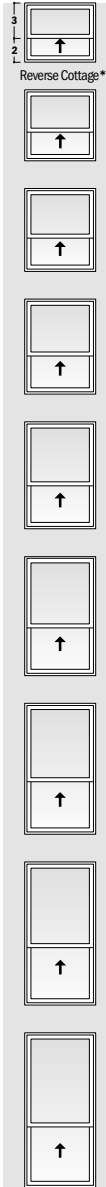

Custom-size windows are available in 1/8" (3) increments. See page 89 for custom sizes and specifications.

Windows with a height greater than 6'-5 1/2" (1969) are only available with a 2:1 reverse cottage sash ratio.

For construction site convenience, an optional drywall pass-through window is available for removal and reinstallation of the upper and lower sash.

Size tables for windows with reverse cottage sash are available on andersenwindows.com.

Details shown on pages 48-51.

Grille patterns shown on page 47.

- *"Window Dimension" always refers to outside frame to frame dimension.
- **"Minimum Rough Opening" dimensions may need to be increased to allow for use of building wraps, flashing, sill panning, brackets, fasteners or other items. See page 109 for more details.
- Dimensions in parentheses are in millimeters.
- ◊ Meet or exceed clear opening area of 5.7 sq.ft. or 0.53 m², clear opening width of 20" (508) and clear opening height of 24" (610). See table on page 39.
- *For reverse cottage sash windows, meeting rail location = (window height in inches x 0.40) + 1.96".
- **For heights greater than 6'-5 1/2" (1969), meeting rail location = (window height in inches x 0.33) + 1.96".
- † Drywall pass-through window available for these standard and reverse cottage sizes and for custom-size windows wider than 1'-11 1/2" (597) and taller than 4'-5 1/2" (1359).

Windows with a height greater than 6'-5 1/2" (1969) are only available with a 2:1 reverse cottage sash ratio.**

continued on next page

Table of Single-Hung Window Sizes (continued)

Scale 1/8" (3) = 1'-0" (305) – 1:96

Window Dimension	1'-5 1/2" (445)	1'-11 1/2" (597)	2'-5 1/2" (749)	2'-11 1/2" (902)	3'-5 1/2" (1054)	3'-11 1/2" (1207)
Minimum Rough Opening	1'-6" (457)	2'-0" (610)	2'-6" (762)	3'-0" (914)	3'-6" (1067)	4'-0" (1219)
Unobstructed Glass	11 1/4" (286)	17 1/4" (438)	23 1/4" (591)	29 1/4" (743)	35 1/4" (895)	41 1/4" (1048)

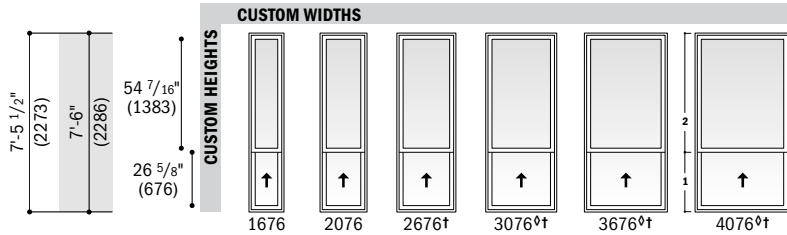

*"Window Dimension" always refers to outside frame to frame dimension.
 **"Minimum Rough Opening" dimensions may need to be increased to allow for use of building wraps, flashing, sill panning, brackets, fasteners or other items. See page 109 for more details.
 • Dimensions in parentheses are in millimeters.
 ◊ Meet or exceed clear opening area of 5.7 sq.ft. or 0.53 m², clear opening width of 20" (508) and clear opening height of 24" (610). See table on page 39.
 **For heights greater than 6'-5 1/2" (1969), meeting rail location = (window height in inches x 0.33) + 1.96".
 †Drywall pass-through window available for these standard and reverse cottage sizes and for custom-size windows wider than 1'-11 1/2" (597) and taller than 4'-5 1/2" (1359).

Windows with a height greater than 6'-5 1/2" (1969) are only available with a 2:1 reverse cottage sash ratio.**

Arch Single-Hung Window Opening and Area Specifications (continued from page 31)

Window Number	Clear Opening Area Sq. Ft./ (m ²)	Clear Opening in Full Open Position		Glass Area Sq. Ft./ (m ²)	Vent Area Sq. Ft./ (m ²)	Top of Subfloor to Top of Inside Sill Stop Inches/(mm)	Overall Window Area Sq. Ft./ (m ²)
		Width Inches/(mm)	Height Inches/(mm)				
3036	3.79 (0.35)	32" (813)	17 1/16" (433)	8.12 (0.75)	3.79 (0.35)	37 3/4" (959)	11.02 (1.02)
3040	4.45 (0.41)	32" (813)	20 1/16" (509)	9.39 (0.87)	4.45 (0.41)	31 3/4" (806)	12.50 (1.16)
3046	5.12 (0.48)	32" (813)	23 1/16" (585)	10.67 (0.99)	5.12 (0.48)	25 3/4" (654)	13.98 (1.30)
3050 ◊	5.79 (0.54)	32" (813)	26 1/16" (661)	11.95 (1.11)	5.79 (0.54)	19 3/4" (501)	15.46 (1.44)
3056 ◊	6.45 (0.60)	32" (813)	29 1/16" (738)	13.22 (1.23)	6.45 (0.60)	13 3/4" (349)	16.94 (1.57)
3060 ◊	7.12 (0.66)	32" (813)	32 1/16" (814)	14.50 (1.35)	7.12 (0.66)	7 3/4" (197)	18.42 (1.71)
3066 ◊	7.79 (0.72)	32" (813)	35 1/16" (890)	15.77 (1.47)	7.79 (0.72)	-	19.90 (1.85)
3070	5.56 (0.52)	32" (813)	25 1/16" (636)	17.30 (1.61)	5.56 (0.52)	-	21.38 (1.99)
3076 ◊	6.01 (0.56)	32" (813)	27 1/16" (687)	18.59 (1.73)	6.01 (0.56)	-	22.86 (2.12)
3626	2.91 (0.27)	38" (965)	11 1/16" (280)	6.79 (0.63)	2.91 (0.27)	48 15/16" (1243)	9.59 (0.89)
3630	3.70 (0.34)	38" (965)	14 1/16" (357)	8.32 (0.77)	3.70 (0.34)	42 15/16" (1091)	11.31 (1.05)
3636	4.50 (0.42)	38" (965)	17 1/16" (433)	9.84 (0.91)	4.50 (0.42)	36 15/16" (938)	13.04 (1.21)
3640	5.29 (0.49)	38" (965)	20 1/16" (509)	11.37 (1.06)	5.29 (0.49)	30 15/16" (786)	14.77 (1.37)
3646	6.08 (0.56)	38" (965)	23 1/16" (585)	12.89 (1.20)	6.08 (0.56)	24 15/16" (633)	16.50 (1.53)
3650 ◊	6.87 (0.64)	38" (965)	26 1/16" (661)	14.42 (1.34)	6.87 (0.64)	18 15/16" (481)	18.23 (1.69)
3656 ◊	7.66 (0.71)	38" (965)	29 1/16" (738)	15.95 (1.48)	7.66 (0.71)	12 15/16" (329)	19.96 (1.85)
3660 ◊	8.45 (0.79)	38" (965)	32 1/16" (814)	17.47 (1.62)	8.45 (0.79)	6 15/16" (176)	21.69 (2.02)
3666 ◊	9.25 (0.86)	38" (965)	35 1/16" (890)	19.00 (1.77)	9.25 (0.86)	-	23.42 (2.18)
3670 ◊	6.61 (0.61)	38" (965)	25 1/16" (636)	20.77 (1.93)	6.61 (0.61)	-	25.15 (2.34)
3676 ◊	7.14 (0.66)	38" (965)	27 1/16" (687)	22.32 (2.07)	7.14 (0.66)	-	26.88 (2.50)

Single-Hung Window Opening and Area Specifications

Window Number	Clear Opening Area Sq. Ft./ (m ²)	Clear Opening in Full Open Position		Glass Area Sq. Ft./ (m ²)	Vent Area Sq. Ft./ (m ²)	Top of Subfloor to Top of Inside Sill Stop Inches/(mm)	Overall Window Area Sq. Ft./ (m ²)
		Width Inches/(mm)	Height Inches/(mm)				
1620	0.78 (0.07)	14" (356)	8 1/16" (204)	1.18 (0.11)	0.78 (0.07)	60 1/2" (1537)	2.86 (0.27)
1626	1.07 (0.10)	14" (356)	11 1/16" (280)	1.65 (0.15)	1.07 (0.10)	54 1/2" (1384)	3.59 (0.33)
1630	1.37 (0.13)	14" (356)	14 1/16" (357)	2.12 (0.20)	1.37 (0.13)	48 1/2" (1232)	4.31 (0.40)
1636	1.66 (0.15)	14" (356)	17 1/16" (433)	2.59 (0.24)	1.66 (0.15)	42 1/2" (1080)	5.04 (0.47)
1640	1.95 (0.18)	14" (356)	20 1/16" (509)	3.05 (0.28)	1.95 (0.18)	36 1/2" (927)	5.77 (0.54)
1646	2.24 (0.21)	14" (356)	23 1/16" (585)	3.52 (0.33)	2.24 (0.21)	30 1/2" (775)	6.50 (0.60)
1650	2.53 (0.24)	14" (356)	26 1/16" (661)	3.99 (0.37)	2.53 (0.24)	24 1/2" (622)	7.23 (0.67)
1656	2.82 (0.26)	14" (356)	29 1/16" (738)	4.46 (0.41)	2.82 (0.26)	18 1/2" (470)	7.96 (0.74)
1660	3.12 (0.29)	14" (356)	32 1/16" (814)	4.93 (0.46)	3.12 (0.29)	12 1/2" (318)	8.69 (0.81)
1666	3.41 (0.32)	14" (356)	35 1/16" (890)	5.40 (0.50)	3.41 (0.32)	6 1/2" (165)	9.42 (0.88)
1670*	2.43 (0.23)	14" (356)	25 1/16" (636)	5.87 (0.55)	2.43 (0.23)	-	10.15 (0.94)

*"Top of Subfloor to Top of Inside Sill Stop" is calculated based upon a structural header height of 6'-10 1/2" (2096).
 • Dimensions in parentheses are in millimeters or square meters.
 ◊ Meet or exceed clear opening area of 5.7 sq.ft. or 0.53 m², clear opening width of 20" (508) and clear opening height of 24" (610).
 *Available only with a 2:1 reverse cottage sash ratio.

continued on page 39

For reverse cottage, twin and triple single-hung window specifications, see pages 41, 43 and 45.

SINGLE-HUNG WINDOWS

Table of Twin and Triple Single-Hung Window Sizes

Scale 1/8" (3) = 1'-0" (305) – 1:96

Window Dimension	2'-11 1/2"	3'-11 1/2"	4'-11 1/2"	5'-11 1/2"	6'-11 1/2"	7'-11 1/2"	4'-5 1/2"
	(902)	(1207)	(1511)	(1816)	(2121)	(2426)	(1359)
Minimum Rough Opening	3'-0"	4'-0"	5'-0"	6'-0"	7'-0"	8'-0"	4'-6"
	(914)	(1219)	(1524)	(1829)	(2134)	(2438)	(1372)
Unobstructed Glass (width of single sash)	11 1/4"	17 1/4"	23 1/4"	29 1/4"	35 1/4"	41 1/4"	11 1/4"
	(286)	(438)	(591)	(743)	(895)	(1048)	(286)

CUSTOM WIDTHS TWIN – 35 1/2" to 95 1/2"

CUSTOM HEIGHTS – 23 1/2" to 71 1/2"	CUSTOM WIDTHS TWIN – 35 1/2" to 95 1/2"							CUSTOM WIDTHS TRIPLE – 45 1/2" to 135 1/2"
	1610-2	2010-2	2610-2	3010-2	3610-2	4010-2	1610-3	
11 1/2" (292)								
1'-5 1/2" (445)								
1'-11 1/2" (597)								
2'-0" (610)								
2'-6" (762)								
3'-0" (914)								
3'-6" (1067)								
4'-0" (1219)								
4'-6" (1372)								
5'-0" (1524)								
5'-6" (1676)								
6'-0" (1829)								
31 9/16" (802)								

* "Window Dimension" always refers to outside frame to frame dimension.
 * "Minimum Rough Opening" dimensions may need to be increased to allow for use of building wraps, flashing, sill panning, brackets, fasteners or other items. See page 109 for more details.
 • Dimensions in parentheses are in millimeters.
 ◊ Meet or exceed clear opening area of 5.7 sq.ft. or 0.53 m², clear opening width of 20" (508) and clear opening height of 24" (610). See tables on pages 43 and 45.

Notes on this page also apply to previous page.

5'-11 1/2" (1816)	7'-5 1/2" (2273)	8'-11 1/2" (2731)	10'-5 1/2" (3188)	11'-11 1/2" (3645)
6'-0" (1829)	7'-6" (2286)	9'-0" (2743)	10'-6" (3200)	12'-0" (3658)
17 1/4" (438)	23 1/4" (591)	29 1/4" (743)	35 1/4" (895)	41 1/4" (1048)

TRIPLE – 53 1/2" to 143 1/2"

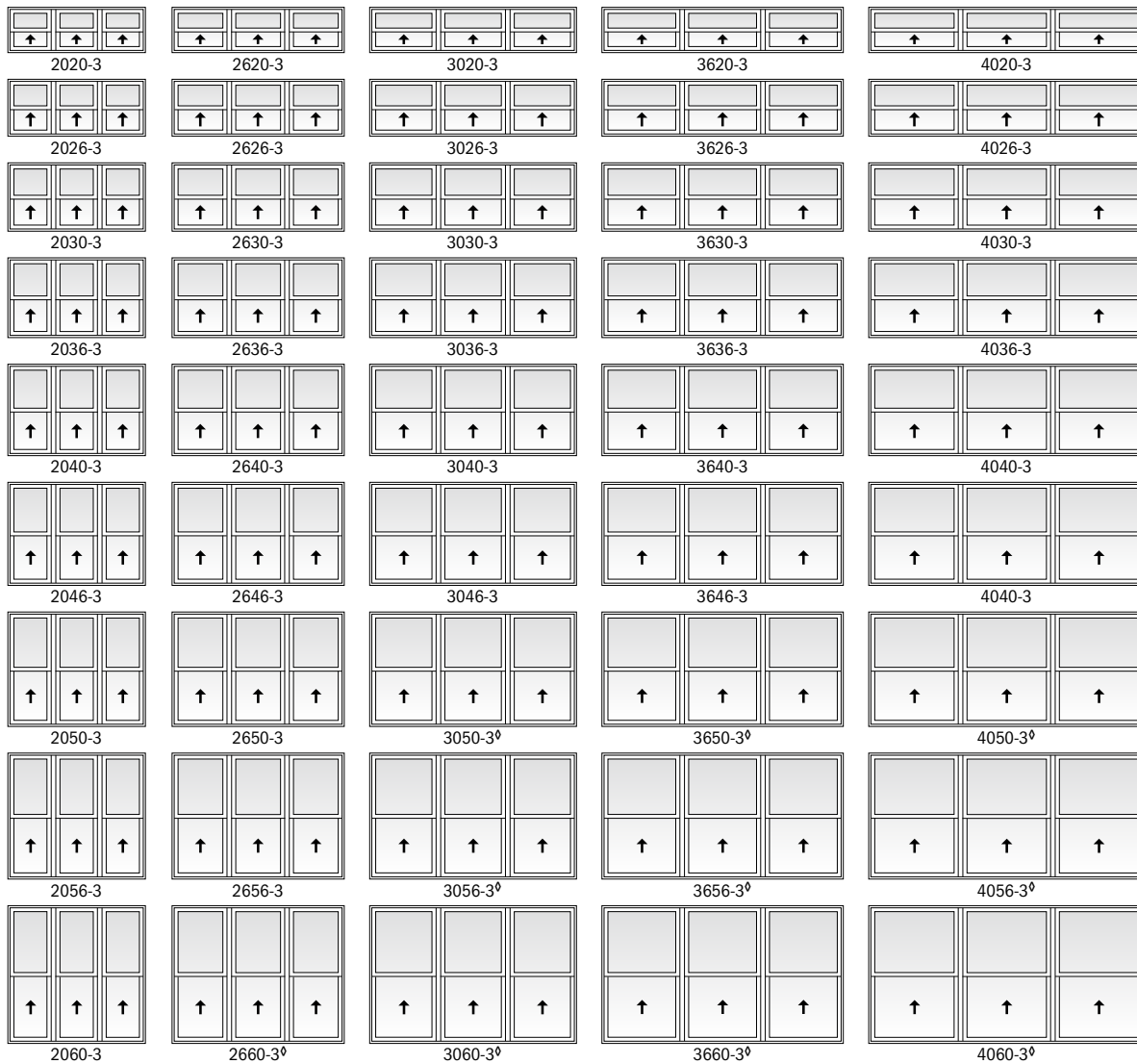
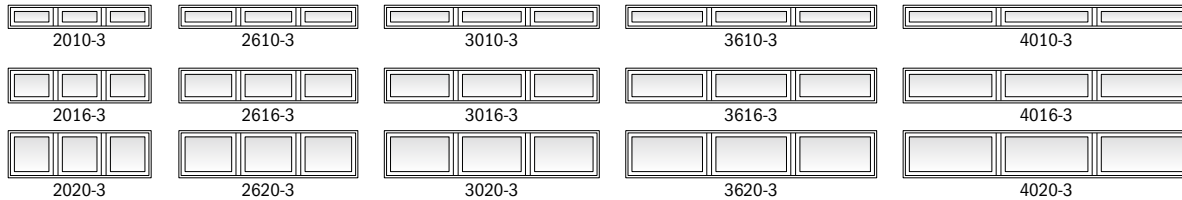

Custom-size windows are available in 1/8" (3) increments. See page 89 for custom sizes and specifications.

Windows have one continuous outer frame.

Twin and triple transoms are also shown. See pages 70-71 for more information.

Details shown on pages 48-51. Grille patterns shown on page 47.















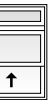



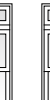



















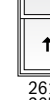

100 Series
Single-Hung Windows

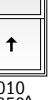
* "Window Dimension" always refers to outside frame to frame dimension.
 ** "Minimum Rough Opening" dimensions may need to be increased to allow for use of building wraps, flashing, sill panning, brackets, fasteners or other items. See page 109 for more details.
 • Dimensions in parentheses are in millimeters.
 ◊ Meet or exceed clear opening area of 5.7 sq.ft. or 0.53 m², clear opening width of 20" (508) and clear opening height of 24" (610). See tables on pages 43 and 45.

SINGLE-HUNG WINDOWS

Table of Sizes for 10-High Transom Window Over Single-Hung

Scale 1/8" (3) = 1'-0" (305) – 1:96

Window Dimension	1'-5 1/2"	1'-11 1/2"	2'-5 1/2"	2'-11 1/2"	3'-5 1/2"	3'-11 1/2"
	(445)	(597)	(749)	(902)	(1054)	(1207)
Minimum Rough Opening	1'-6"	2'-0"	2'-6"	3'-0"	3'-6"	4'-0"
	(457)	(610)	(762)	(914)	(1067)	(1219)
Unobstructed Glass <small>(height of individual single-hung sash only)</small>	11 1/4"	17 1/4"	23 1/4"	29 1/4"	35 1/4"	41 1/4"
	(286)	(438)	(591)	(743)	(895)	(1048)
3'-11 1/2"						
	1610 1630	2010 2030	2610 2630	3010 3030	3610 3630	4010 4030
4'-5 1/2"						
	1610 1636	2010 2036	2610 2636	3010 3036	3610 3636	4010 4036
4'-11 1/2"						
	1610 1640	2010 2040	2610 2640	3010 3040	3610 3640	4010 4040
5'-5 1/2"						
	1610 1646	2010 2046	2610 2646	3010 3046	3610 3646	4010 4046
5'-11 1/2"						
	1610 1650	2010 2050	2610 2650	3010 3050 ^o	3610 3650 ^o	4010 4050 ^o
6'-5 1/2"						
	1610 1656	2010 2056	2610 2656	3010 3056 ^o	3610 3656 ^o	4010 4056 ^o
6'-11 1/2"						
	1610 1660	2010 2060	2610 2660 ^o	3010 3060 ^o	3610 3660 ^o	4010 4060 ^o

Windows have one continuous outer frame.

Unobstructed glass height dimension of upper transom sash is 5 1/4" (133).

Details shown on pages 48-51.

Grille patterns shown on page 47.

• "Window Dimension" always refers to outside frame to frame dimension.
 • "Minimum Rough Opening" dimensions may need to be increased to allow for use of building wraps, flashing, sill panning, brackets, fasteners or other items. See page 109 for more details.
 • Dimensions in parentheses are in millimeters.
^o Meet or exceed clear opening area of 5.7 sq.ft. or 0.53 m², clear opening width of 20" (508) and clear opening height of 24" (610).

Table of Sizes for 16-High Transom Window Over Single-Hung

Scale 1/8" (3) = 1'-0" (305) – 1:96

Window Dimension	1'-5 1/2" (445)	1'-11 1/2" (597)	2'-5 1/2" (749)	2'-11 1/2" (902)	3'-5 1/2" (1054)	3'-11 1/2" (1207)
Minimum Rough Opening	1'-6" (457)	2'-0" (610)	2'-6" (762)	3'-0" (914)	3'-6" (1067)	4'-0" (1219)
Unobstructed Glass <small>(height of individual single-hung sash only)</small>	11 1/4" (286)	17 1/4" (438)	23 1/4" (591)	29 1/4" (743)	35 1/4" (895)	41 1/4" (1048)

4'-5 1/2" (1359)	4'-6" (1372)	4'-6" (1372)	4'-6" (1372)	4'-6" (1372)	4'-6" (1372)	4'-6" (1372)
1616	2016	2616	3016	3616	4016	
1630	2030	2630	3030	3630	4030	
4'-11 1/2" (1511)	5'-0" (1524)	5'-0" (1524)	5'-0" (1524)	5'-0" (1524)	5'-0" (1524)	5'-0" (1524)
1616	2016	2616	3016	3616	4016	
1636	2036	2636	3036	3636	4036	
5'-5 1/2" (1664)	5'-6" (1676)	5'-6" (1676)	5'-6" (1676)	5'-6" (1676)	5'-6" (1676)	5'-6" (1676)
1616	2016	2616	3016	3616	4016	
1640	2040	2640	3040	3640	4040	
5'-11 1/2" (1816)	6'-0" (1829)	6'-0" (1829)	6'-0" (1829)	6'-0" (1829)	6'-0" (1829)	6'-0" (1829)
1616	2016	2616	3016	3616	4016	
1646	2046	2646	3046	3646	4046	
6'-5 1/2" (1969)	6'-6" (1981)	6'-6" (1981)	6'-6" (1981)	6'-6" (1981)	6'-6" (1981)	6'-6" (1981)
1616	2016	2616	3016	3616	4016	
1650	2050	2650	3050 ^o	3650 ^o	4050 ^o	
6'-11 1/2" (2121)	7'-0" (2134)	7'-0" (2134)	7'-0" (2134)	7'-0" (2134)	7'-0" (2134)	7'-0" (2134)
1616	2016	2616	3016	3616	4016	
1656	2056	2656	3056 ^o	3656 ^o	4056 ^o	
7'-5 1/2" (2273)	7'-6" (2286)	7'-6" (2286)	7'-6" (2286)	7'-6" (2286)	7'-6" (2286)	7'-6" (2286)
1616	2016	2616	3016	3616	4016	
1660	2060	2660 ^o	3060 ^o	3660 ^o	4060 ^o	

Windows have one continuous outer frame.

Unobstructed glass height dimension of upper transom sash is 11 1/4" (286).

Details shown on pages 48-51.

Grille patterns shown on page 47.

* "Window Dimension" always refers to outside frame to frame dimension.
 • "Minimum Rough Opening" dimensions may need to be increased to allow for use of building wraps, flashing, sill panning, brackets, fasteners or other items. See page 109 for more details.
 • Dimensions in parentheses are in millimeters.
 ◊ Meet or exceed clear opening area of 5.7 sq.ft. or 0.53 m², clear opening width of 20" (508) and clear opening height of 24" (610).

SINGLE-HUNG WINDOWS

Table of Sizes for 20-High Transom Window Over Single-Hung

Scale 1/8" (3) = 1'-0" (305) – 1:96

Window Dimension	1'-5 1/2"	1'-11 1/2"	2'-5 1/2"	2'-11 1/2"	3'-5 1/2"	3'-11 1/2"
	(445)	(597)	(749)	(902)	(1054)	(1207)
Minimum Rough Opening	1'-6"	2'-0"	2'-6"	3'-0"	3'-6"	4'-0"
	(457)	(610)	(762)	(914)	(1067)	(1219)
Unobstructed Glass <small>(height of individual single-hung sash only)</small>	11 1/4"	17 1/4"	23 1/4"	29 1/4"	35 1/4"	41 1/4"
	(286)	(438)	(591)	(743)	(895)	(1048)

4'-11 1/2"	(1511)	(1511)	(1511)	(1511)	(1511)	(1511)
5'-0"	(1524)	(1524)	(1524)	(1524)	(1524)	(1524)
13 9/16"	(345)	(345)	(345)	(345)	(345)	(345)
	1620	2020	2620	3020	3620	4020
	1630	2030	2630	3030	3630	4030
5'-5 1/2"	(1664)	(1664)	(1664)	(1664)	(1664)	(1664)
5'-6"	(1676)	(1676)	(1676)	(1676)	(1676)	(1676)
16 9/16"	(421)	(421)	(421)	(421)	(421)	(421)
	1620	2020	2620	3020	3620	4020
	1636	2036	2636	3036	3636	4036
5'-11 1/2"	(1816)	(1816)	(1816)	(1816)	(1816)	(1816)
6'-0"	(1829)	(1829)	(1829)	(1829)	(1829)	(1829)
19 9/16"	(497)	(497)	(497)	(497)	(497)	(497)
	1620	2020	2620	3020	3620	4020
	1640	2040	2640	3040	3640	4040
6'-5 1/2"	(1969)	(1969)	(1969)	(1969)	(1969)	(1969)
6'-6"	(1981)	(1981)	(1981)	(1981)	(1981)	(1981)
22 9/16"	(573)	(573)	(573)	(573)	(573)	(573)
	1620	2020	2620	3020	3620	4020
	1646	2046	2646	3046	3646	4046
6'-11 1/2"	(2121)	(2121)	(2121)	(2121)	(2121)	(2121)
7'-0"	(2134)	(2134)	(2134)	(2134)	(2134)	(2134)
25 9/16"	(649)	(649)	(649)	(649)	(649)	(649)
	1620	2020	2620	3020	3620	4020
	1650	2050	2650	3050 [◊]	3650 [◊]	4050 [◊]
7'-5 1/2"	(2273)	(2273)	(2273)	(2273)	(2273)	(2273)
7'-6"	(2286)	(2286)	(2286)	(2286)	(2286)	(2286)
28 9/16"	(726)	(726)	(726)	(726)	(726)	(726)
	1620	2020	2620	3020	3620	4020
	1656	2056	2656	3056 [◊]	3656 [◊]	4056 [◊]
7'-11 1/2"	(2426)	(2426)	(2426)	(2426)	(2426)	(2426)
8'-0"	(2438)	(2438)	(2438)	(2438)	(2438)	(2438)
31 9/16"	(802)	(802)	(802)	(802)	(802)	(802)
	1620	2020	2620	3020	3620	4020
	1660	2060	2660 [◊]	3060 [◊]	3660 [◊]	4060 [◊]

Windows have one continuous outer frame.

Unobstructed glass height dimension of upper transom sash is 17 1/4" (438).

Details shown on pages 48-51.

Grille patterns shown on page 47.

* "Window Dimension" always refers to outside frame to frame dimension.

◊ "Minimum Rough Opening" dimensions may need to be increased to allow for use of building wraps, flashing, sill panning, brackets, fasteners or other items. See page 109 for more details.

• Dimensions in parentheses are in millimeters.

◊ Meet or exceed clear opening area of 5.7 sq.ft. or 0.53 m², clear opening width of 20" (508) and clear opening height of 24" (610).

Single-Hung Window Opening and Area Specifications (continued from page 33)

Window Number	Clear Opening Area Sq. Ft./ (m ²)		Clear Opening in Full Open Position		Glass Area Sq. Ft./ (m ²)	Vent Area Sq. Ft./ (m ²)	Top of Subfloor to Top of Inside Sill Stop Inches/(mm)	Overall Window Area Sq. Ft./ (m ²)
			Width Inches/(mm)	Height Inches/(mm)				
1676*	2.63 (0.24)	14" (356)	27 1/16" (687)	6.34 (0.59)	2.63 (0.24)	-	10.88 (1.01)	
2020	1.12 (0.10)	20" (508)	8 1/16" (204)	1.81 (0.17)	1.12 (0.10)	60 1/2" (1537)	3.84 (0.36)	
2026	1.53 (0.14)	20" (508)	11 1/16" (280)	2.53 (0.24)	1.53 (0.14)	54 1/2" (1384)	4.81 (0.45)	
2030	1.95 (0.18)	20" (508)	14 1/16" (357)	3.25 (0.30)	1.95 (0.18)	48 1/2" (1232)	5.79 (0.54)	
2036	2.37 (0.22)	20" (508)	17 1/16" (433)	3.96 (0.37)	2.37 (0.22)	42 1/2" (1080)	6.77 (0.63)	
2040	2.78 (0.26)	20" (508)	20 1/16" (509)	4.68 (0.44)	2.78 (0.26)	36 1/2" (927)	7.75 (0.72)	
2046	3.20 (0.30)	20" (508)	23 1/16" (585)	5.40 (0.50)	3.20 (0.30)	30 1/2" (775)	8.73 (0.81)	
2050	3.62 (0.34)	20" (508)	26 1/16" (661)	6.12 (0.57)	3.62 (0.34)	24 1/2" (622)	9.71 (0.90)	
2056	4.03 (0.38)	20" (508)	29 1/16" (738)	6.84 (0.64)	4.03 (0.38)	18 1/2" (470)	10.69 (0.99)	
2060	4.45 (0.41)	20" (508)	32 1/16" (814)	7.56 (0.70)	4.45 (0.41)	12 1/2" (318)	11.67 (1.08)	
2066	4.87 (0.45)	20" (508)	35 1/16" (890)	8.28 (0.77)	4.87 (0.45)	6 1/2" (165)	12.65 (1.18)	
2070*	3.48 (0.32)	20" (508)	25 1/16" (636)	9.00 (0.84)	3.48 (0.32)	-	13.63 (1.27)	
2076*	3.76 (0.35)	20" (508)	27 1/16" (687)	9.71 (0.90)	3.76 (0.35)	-	14.61 (1.36)	
2620	1.45 (0.14)	26" (660)	8 1/16" (204)	2.44 (0.23)	1.45 (0.14)	60 1/2" (1537)	4.81 (0.45)	
2626	1.99 (0.19)	26" (660)	11 1/16" (280)	3.41 (0.32)	1.99 (0.19)	54 1/2" (1384)	6.04 (0.56)	
2630	2.54 (0.24)	26" (660)	14 1/16" (357)	4.37 (0.41)	2.54 (0.24)	48 1/2" (1232)	7.27 (0.68)	
2636	3.08 (0.29)	26" (660)	17 1/16" (433)	5.34 (0.50)	3.08 (0.29)	42 1/2" (1080)	8.50 (0.79)	
2640	3.62 (0.34)	26" (660)	20 1/16" (509)	6.31 (0.59)	3.62 (0.34)	36 1/2" (927)	9.73 (0.90)	
2646	4.16 (0.39)	26" (660)	23 1/16" (585)	7.28 (0.68)	4.16 (0.39)	30 1/2" (775)	10.96 (1.02)	
2650	4.70 (0.44)	26" (660)	26 1/16" (661)	8.25 (0.77)	4.70 (0.44)	24 1/2" (622)	12.19 (1.13)	
2656	5.24 (0.49)	26" (660)	29 1/16" (738)	9.22 (0.86)	5.24 (0.49)	18 1/2" (470)	13.42 (1.25)	
2660 ◊	5.79 (0.54)	26" (660)	32 1/16" (814)	10.19 (0.95)	5.79 (0.54)	12 1/2" (318)	14.65 (1.36)	
2666 ◊	6.33 (0.59)	26" (660)	35 1/16" (890)	11.16 (1.04)	6.33 (0.45)	6 1/2" (165)	15.88 (1.48)	
2670*	4.52 (0.42)	26" (660)	25 1/16" (636)	12.12 (1.13)	4.52 (0.42)	-	17.11 (1.59)	
2676*	4.88 (0.45)	26" (660)	27 1/16" (687)	13.09 (1.22)	4.88 (0.45)	-	18.34 (1.70)	
3020	1.79 (0.17)	32" (813)	8 1/16" (204)	3.07 (0.29)	1.79 (0.17)	60 1/2" (1537)	5.79 (0.54)	
3026	2.45 (0.23)	32" (813)	11 1/16" (280)	4.28 (0.40)	2.45 (0.23)	54 1/2" (1384)	7.27 (0.68)	
3030	3.12 (0.29)	32" (813)	14 1/16" (357)	5.50 (0.51)	3.12 (0.29)	48 1/2" (1232)	8.75 (0.81)	
3036	3.79 (0.35)	32" (813)	17 1/16" (433)	6.72 (0.62)	3.79 (0.35)	42 1/2" (1080)	10.23 (0.95)	
3040	4.45 (0.41)	32" (813)	20 1/16" (509)	7.94 (0.74)	4.45 (0.41)	36 1/2" (927)	11.71 (1.09)	
3046	5.12 (0.48)	32" (813)	23 1/16" (585)	9.16 (0.85)	5.12 (0.48)	30 1/2" (775)	13.19 (1.23)	
3050 ◊	5.79 (0.54)	32" (813)	26 1/16" (661)	10.38 (0.96)	5.79 (0.54)	24 1/2" (622)	14.67 (1.36)	
3056 ◊	6.45 (0.60)	32" (813)	29 1/16" (738)	11.60 (1.08)	6.45 (0.60)	18 1/2" (470)	16.15 (1.50)	
3060 ◊	7.12 (0.66)	32" (813)	32 1/16" (814)	12.82 (1.19)	7.12 (0.66)	12 1/2" (318)	17.63 (1.64)	
3066 ◊	7.79 (0.72)	32" (813)	35 1/16" (890)	14.03 (1.30)	7.79 (0.72)	6 1/2" (165)	19.11 (1.78)	
3070*	5.56 (0.52)	32" (813)	25 1/16" (636)	15.25 (1.42)	5.56 (0.52)	-	20.59 (1.91)	
3076 ◊*	6.01 (0.56)	32" (813)	27 1/16" (687)	16.47 (1.53)	6.01 (0.56)	-	22.06 (2.05)	
3620	2.12 (0.20)	38" (965)	8 1/16" (204)	3.69 (0.34)	2.12 (0.20)	60 1/2" (1537)	6.77 (0.63)	
3626	2.91 (0.27)	38" (965)	11 1/16" (280)	5.16 (0.48)	2.91 (0.27)	54 1/2" (1384)	8.50 (0.79)	
3630	3.71 (0.34)	38" (965)	14 1/16" (357)	6.63 (0.62)	3.71 (0.34)	48 1/2" (1232)	10.23 (0.95)	
3636	4.50 (0.42)	38" (965)	17 1/16" (433)	8.10 (0.75)	4.50 (0.42)	42 1/2" (1080)	11.96 (1.11)	
3640	5.29 (0.49)	38" (965)	20 1/16" (509)	9.57 (0.89)	5.29 (0.49)	36 1/2" (927)	13.69 (1.27)	
3646	6.08 (0.57)	38" (965)	23 1/16" (585)	11.04 (1.03)	6.08 (0.57)	30 1/2" (775)	15.42 (1.43)	
3650 ◊	6.87 (0.64)	38" (965)	26 1/16" (661)	12.51 (1.16)	6.87 (0.64)	24 1/2" (622)	17.15 (1.59)	
3656 ◊	7.66 (0.71)	38" (965)	29 1/16" (738)	13.98 (1.30)	7.66 (0.71)	18 1/2" (470)	18.88 (1.75)	
3660 ◊	8.46 (0.79)	38" (965)	32 1/16" (814)	15.44 (1.44)	8.46 (0.79)	12 1/2" (318)	20.61 (1.91)	
3666 ◊	9.25 (0.86)	38" (965)	35 1/16" (890)	16.91 (1.57)	9.25 (0.86)	6 1/2" (165)	22.34 (2.08)	
3670 ◊*	6.61 (0.61)	38" (965)	25 1/16" (636)	18.38 (1.71)	6.61 (0.61)	-	24.06 (2.24)	
3676 ◊*	7.14 (0.66)	38" (965)	27 1/16" (687)	19.85 (1.84)	7.14 (0.66)	-	25.79 (2.40)	
4020	2.46 (0.23)	44" (1118)	8 1/16" (204)	4.32 (0.40)	2.46 (0.23)	60 1/2" (1537)	7.75 (0.72)	
4026	3.37 (0.31)	44" (1118)	11 1/16" (280)	6.04 (0.56)	3.37 (0.31)	54 1/2" (1384)	9.73 (0.90)	
4030	4.29 (0.40)	44" (1118)	14 1/16" (357)	7.76 (0.72)	4.29 (0.40)	48 1/2" (1232)	11.71 (1.09)	
4036	5.21 (0.48)	44" (1118)	17 1/16" (433)	9.48 (0.88)	5.21 (0.48)	42 1/2" (1080)	13.69 (1.27)	
4040	6.12 (0.57)	44" (1118)	20 1/16" (509)	11.20 (1.04)	6.12 (0.57)	36 1/2" (927)	15.67 (1.46)	
4046	7.04 (0.65)	44" (1118)	23 1/16" (585)	12.92 (1.20)	7.04 (0.65)	30 1/2" (775)	17.65 (1.64)	
4050 ◊	7.96 (0.74)	44" (1118)	26 1/16" (661)	14.64 (1.36)	7.96 (0.74)	24 1/2" (622)	19.63 (1.82)	
4056 ◊	8.87 (0.82)	44" (1118)	29 1/16" (738)	16.35 (1.52)	8.87 (0.82)	18 1/2" (470)	21.61 (2.01)	
4060 ◊	9.79 (0.91)	44" (1118)	32 1/16" (814)	18.07 (1.68)	9.79 (0.91)	12 1/2" (318)	23.59 (2.19)	
4066 ◊	10.71 (1.00)	44" (1118)	35 1/16" (890)	19.79 (1.84)	10.70 (1.00)	6 1/2" (165)	25.56 (2.38)	
4070 ◊*	7.65 (0.71)	44" (1118)	25 1/16" (636)	21.51 (2.00)	7.65 (0.71)	-	27.54 (2.56)	
4076 ◊*	8.26 (0.77)	44" (1118)	27 1/16" (687)	23.23 (2.16)	8.26 (0.77)	-	29.52 (2.74)	

For arch single-hung window specifications, see pages 31 and 33.

For reverse cottage, twin and triple single-hung window specifications, see pages 41, 43 and 45.

* "Top of Subfloor to Top of Inside Sill Stop" is calculated based upon a structural header height of 6'-10 1/2" (2096).
 ◊ Meet or exceed clear opening area of 5.7 sq.ft. or 0.53 m²; clear opening width of 20" (508) and clear opening height of 24" (610).
 * Available only with a 2:1 reverse cottage sash ratio.

SINGLE-HUNG WINDOWS

Table of Sizes for Picture Window with Flanking 16-Wide Single-Hungs

Scale 1/8" (3) = 1'-0" (305) – 1:96

Window Dimension	5'-11 1/2" (1816)	6'-5 1/2" (1969)	6'-11 1/2" (2121)	7'-5 1/2" (2273)	7'-11 1/2" (2426)	8'-5 1/2" (2578)
Minimum Rough Opening	6'-0" (1829)	6'-6" (1981)	7'-0" (2134)	7'-6" (2286)	8'-0" (2438)	8'-6" (2591)
Unobstructed Glass (center sash only)	29 1/4" (743)	35 1/4" (895)	41 1/4" (1048)	47 1/4" (1200)	53 1/4" (1353)	59 1/4" (1505)

11 1/4" (292)	1'-0" (305)	5 1/4" (133)						
1'-5 1/2" (445)	1'-6" (457)	11 1/4" (286)						
1'-11 1/2" (497)	2'-0" (610)	17 1/4" (438)						
3'-11 1/2" (1207)	4'-0" (1219)	41 1/4" (1048)						
4'-5 1/2" (1359)	4'-6" (1372)	47 1/4" (1200)						
4'-11 1/2" (1511)	5'-0" (1524)	53 1/4" (1353)						
5'-5 1/2" (1664)	5'-6" (1676)	59 1/4" (1505)						
5'-11 1/2" (1816)	6'-0" (1829)	65 1/4" (1657)						

Windows have one continuous outer frame.

Unobstructed glass width dimension of flanking sash is 11 1/4" (286). For unobstructed glass height dimensions of flanking single-hungs, see page 32.

Matching transoms are also shown.

Details shown on pages 48-51.

Grille patterns shown on page 47.

- "Window Dimension" always refers to outside frame to frame dimension.
- "Minimum Rough Opening" dimensions may need to be increased to allow for use of building wraps, flashing, sill panning, brackets, fasteners or other items. See page 109 for more details.
- Dimensions in parentheses are in millimeters.

See notes on previous page.

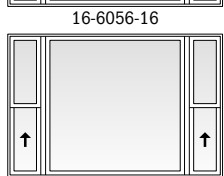
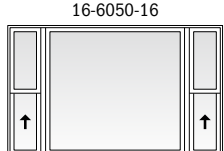
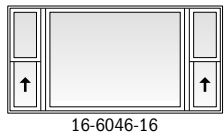
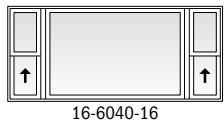
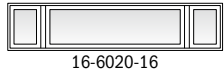
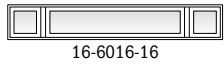
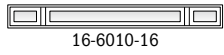
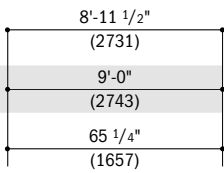

Single-Hung Window Opening and Area Specifications - 3:2 Reverse Cottage Sash Ratio

Window Number	Clear Opening Area		Clear Opening in Full Open Position		Glass Area		Vent Area		Top of Subfloor to Top of Inside Sill Stop Inches/(mm)	Overall Window Area		
	Sq. Ft./	(m ²)	Width Inches/(mm)	Height Inches/(mm)	Sq. Ft./	(m ²)	Sq. Ft./	(m ²)				
1626	0.88	(0.08)	14"	(356)	9 1/16"	(230)	1.65	(0.15)	54 1/2"	(1384)	3.59	(0.33)
1630	1.07	(0.10)	14"	(356)	11 1/16"	(280)	2.12	(0.20)	48 1/2"	(1232)	4.31	(0.40)
1636	1.37	(0.13)	14"	(356)	14 1/16"	(357)	2.59	(0.24)	42 1/2"	(1080)	5.04	(0.47)
1640	1.56	(0.15)	14"	(356)	16 1/16"	(407)	3.05	(0.28)	36 1/2"	(927)	5.77	(0.54)
1646	1.85	(0.17)	14"	(356)	19 1/16"	(484)	3.52	(0.33)	30 1/2"	(775)	6.50	(0.60)
1650	2.05	(0.19)	14"	(356)	21 1/16"	(534)	3.99	(0.37)	24 1/2"	(622)	7.23	(0.67)
1656	2.24	(0.21)	14"	(356)	23 1/16"	(585)	4.46	(0.41)	18 1/2"	(470)	7.96	(0.74)
1660	2.53	(0.24)	14"	(356)	26 1/16"	(661)	4.93	(0.46)	12 1/2"	(318)	8.69	(0.81)
1666	2.73	(0.25)	14"	(356)	28 1/16"	(712)	5.40	(0.50)	6 1/2"	(165)	9.42	(0.88)
2026	1.26	(0.12)	20"	(508)	9 1/16"	(230)	2.53	(0.24)	54 1/2"	(1384)	4.81	(0.45)
2030	1.53	(0.14)	20"	(508)	11 1/16"	(280)	3.25	(0.30)	48 1/2"	(1232)	5.79	(0.54)
2036	1.95	(0.18)	20"	(508)	14 1/16"	(357)	3.96	(0.37)	42 1/2"	(1080)	6.77	(0.63)
2040	2.23	(0.21)	20"	(508)	16 1/16"	(407)	4.68	(0.44)	36 1/2"	(927)	7.75	(0.72)
2046	2.64	(0.25)	20"	(508)	19 1/16"	(484)	5.40	(0.50)	30 1/2"	(775)	8.73	(0.81)
2050	2.92	(0.27)	20"	(508)	21 1/16"	(534)	6.12	(0.57)	24 1/2"	(622)	9.71	(0.90)
2056	3.20	(0.30)	20"	(508)	23 1/16"	(585)	6.84	(0.64)	18 1/2"	(470)	10.69	(0.99)
2060	3.62	(0.34)	20"	(508)	26 1/16"	(661)	7.56	(0.70)	12 1/2"	(318)	11.67	(1.08)
2066	3.89	(0.36)	20"	(508)	28 1/16"	(712)	8.28	(0.77)	6 1/2"	(165)	12.65	(1.18)
2626	1.63	(0.15)	26"	(660)	9 1/16"	(230)	3.41	(0.32)	54 1/2"	(1384)	6.04	(0.56)
2630	1.99	(0.19)	26"	(660)	11 1/16"	(280)	4.37	(0.41)	48 1/2"	(1232)	7.27	(0.68)
2636	2.54	(0.24)	26"	(660)	14 1/16"	(357)	5.34	(0.50)	42 1/2"	(1080)	8.50	(0.79)
2640	2.90	(0.27)	26"	(660)	16 1/16"	(407)	6.31	(0.59)	36 1/2"	(927)	9.73	(0.90)
2646	3.44	(0.32)	26"	(660)	19 1/16"	(484)	7.28	(0.68)	30 1/2"	(775)	10.96	(1.02)
2650	3.80	(0.35)	26"	(660)	21 1/16"	(534)	8.25	(0.77)	24 1/2"	(622)	12.19	(1.13)
2656	4.16	(0.39)	26"	(660)	23 1/16"	(585)	9.22	(0.86)	18 1/2"	(470)	13.42	(1.25)
2660	4.70	(0.44)	26"	(660)	26 1/16"	(661)	10.19	(0.95)	12 1/2"	(318)	14.65	(1.36)
2666	5.06	(0.47)	26"	(660)	28 1/16"	(712)	11.16	(1.04)	6 1/2"	(165)	15.88	(1.48)
3026	2.01	(0.19)	32"	(813)	9 1/16"	(230)	4.28	(0.40)	54 1/2"	(1384)	7.27	(0.68)
3030	2.45	(0.23)	32"	(813)	11 1/16"	(280)	5.50	(0.51)	48 1/2"	(1232)	8.75	(0.81)
3036	3.12	(0.29)	32"	(813)	14 1/16"	(357)	6.72	(0.62)	42 1/2"	(1080)	10.23	(0.95)
3040	3.56	(0.33)	32"	(813)	16 1/16"	(407)	7.94	(0.74)	36 1/2"	(927)	11.71	(1.09)
3046	4.23	(0.39)	32"	(813)	19 1/16"	(484)	9.16	(0.85)	30 1/2"	(775)	13.19	(1.23)
3050	4.68	(0.43)	32"	(813)	21 1/16"	(534)	10.38	(0.96)	24 1/2"	(622)	14.67	(1.36)
3056	5.12	(0.48)	32"	(813)	23 1/16"	(585)	11.60	(1.08)	18 1/2"	(470)	16.15	(1.50)
3060 ◊	5.79	(0.54)	32"	(813)	26 1/16"	(661)	12.82	(1.19)	12 1/2"	(318)	17.63	(1.64)
3066 ◊	6.23	(0.58)	32"	(813)	28 1/16"	(712)	14.03	(1.30)	6 1/2"	(165)	19.11	(1.78)
3626	2.39	(0.22)	38"	(965)	9 1/16"	(230)	5.16	(0.48)	54 1/2"	(1384)	8.50	(0.79)
3630	2.91	(0.27)	38"	(965)	11 1/16"	(280)	6.63	(0.62)	48 1/2"	(1232)	10.23	(0.95)
3636	3.71	(0.34)	38"	(965)	14 1/16"	(357)	8.10	(0.75)	42 1/2"	(1080)	11.96	(1.11)
3640	4.23	(0.39)	38"	(965)	16 1/16"	(407)	9.57	(0.89)	36 1/2"	(927)	13.69	(1.27)
3646	5.02	(0.47)	38"	(965)	19 1/16"	(484)	11.04	(1.03)	30 1/2"	(775)	15.42	(1.43)
3650	5.55	(0.52)	38"	(965)	21 1/16"	(534)	12.51	(1.16)	24 1/2"	(622)	17.15	(1.59)
3656	6.08	(0.57)	38"	(965)	23 1/16"	(585)	13.98	(1.30)	18 1/2"	(470)	18.88	(1.75)
3660 ◊	6.87	(0.64)	38"	(965)	26 1/16"	(661)	15.44	(1.44)	12 1/2"	(318)	20.61	(1.91)
3666 ◊	7.40	(0.69)	38"	(965)	28 1/16"	(712)	16.91	(1.57)	6 1/2"	(165)	22.34	(2.08)
4026	2.76	(0.26)	44"	(1118)	9 1/16"	(230)	6.04	(0.56)	54 1/2"	(1384)	9.73	(0.90)
4030	3.37	(0.31)	44"	(1118)	11 1/16"	(280)	7.76	(0.72)	48 1/2"	(1232)	11.71	(1.09)
4036	4.29	(0.40)	44"	(1118)	14 1/16"	(357)	9.48	(0.88)	42 1/2"	(1080)	13.69	(1.27)
4040	4.90	(0.46)	44"	(1118)	16 1/16"	(407)	11.20	(1.04)	36 1/2"	(927)	15.67	(1.46)
4046	5.82	(0.54)	44"	(1118)	19 1/16"	(484)	12.92	(1.20)	30 1/2"	(775)	17.65	(1.64)
4050	6.43	(0.60)	44"	(1118)	21 1/16"	(534)	14.64	(1.36)	24 1/2"	(622)	19.63	(1.82)
4056	7.04	(0.65)	44"	(1118)	23 1/16"	(585)	16.35	(1.52)	18 1/2"	(470)	21.61	(2.01)
4060 ◊	7.96	(0.74)	44"	(1118)	26 1/16"	(661)	18.07	(1.68)	12 1/2"	(318)	23.59	(2.19)
4066 ◊	8.57	(0.80)	44"	(1118)	28 1/16"	(712)	19.79	(1.84)	6 1/2"	(165)	25.56	(2.38)

Top of Subfloor to Top of Inside Sill Stop is calculated based upon a structural header height of 6'-10 1/2" (2096).

*Dimensions in parentheses are in millimeters or square meters.

◊Meet or exceed clear opening area of 5.7 sq.ft. or 0.53 m², clear opening width of 20" (508) and clear opening height of 24" (610).

100 Series
Single-Hung Windows

SINGLE-HUNG WINDOWS

Table of Sizes for Picture Window with Flanking 20-Wide Single-Hungs

Scale 1/8" (3) = 1'-0" (305) – 1:96

Window Dimension	6'-11 1/2" (2121)	7'-5 1/2" (2273)	7'-11 1/2" (2426)	8'-5 1/2" (2578)	8'-11 1/2" (2731)
Minimum Rough Opening	7'-0" (2134)	7'-6" (2286)	8'-0" (2438)	8'-6" (2591)	9'-0" (2743)
Unobstructed Glass (center sash only)	29 1/4" (743)	35 1/4" (895)	41 1/4" (1048)	47 1/4" (1200)	53 1/4" (1353)

11 1/2" (292)	1'-0" (305)	5 1/4" (133)					
1'-5 1/2" (445)	1'-6" (457)	11 1/4" (286)					
1'-11 1/2" (597)	2'-0" (610)	17 1/4" (438)					
3'-11 1/2" (1207)	4'-0" (1219)	41 1/4" (1048)					
4'-5 1/2" (1359)	4'-6" (1372)	47 1/4" (1200)					
4'-11 1/2" (1511)	5'-0" (1524)	53 1/4" (1353)					
5'-5 1/2" (1664)	5'-6" (1676)	59 1/4" (1505)					
5'-11 1/2" (1816)	6'-0" (1829)	65 1/4" (1657)					

Windows have one continuous outer frame.

Unobstructed glass width dimension of flanking sash is 17 1/4" (438). For unobstructed glass height dimensions of flanking single-hungs, see page 32.

Matching transoms are also shown.

Details shown on pages 48-51.

Grille patterns shown on page 47.

• "Window Dimension" always refers to outside frame to frame dimension.
 • "Minimum Rough Opening" dimensions may need to be increased to allow for use of building wraps, flashing, sill panning, brackets, fasteners or other items. See page 109 for more details.
 • Dimensions in parentheses are in millimeters.

See notes on previous page.

Twin Single-Hung Window Opening and Area Specifications

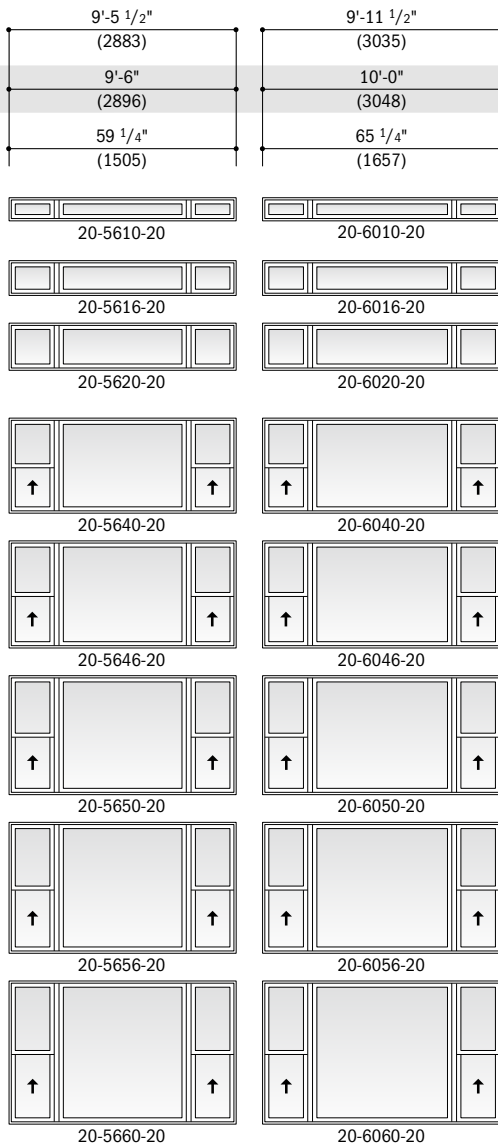

Window Number	Clear Opening Area Sq. Ft./ (m ²)	Clear Opening in Full Open Position		Glass Area Sq. Ft./ (m ²)	Vent Area Sq. Ft./ (m ²)	Top of Subfloor to Top of Inside Sill Stop Inches/ (mm)	Overall Window Area Sq. Ft./ (m ²)
		Width Inches/ (mm)	Height Inches/ (mm)				
1620-2	0.78 (0.07)	14" (356)	8 1/16" (204)	2.36 (0.22)	1.56 (0.15)	60 1/2" (1537)	5.79 (0.54)
1626-2	1.07 (0.10)	14" (356)	11 1/16" (280)	3.30 (0.31)	2.15 (0.20)	54 1/2" (1384)	7.27 (0.68)
1630-2	1.37 (0.13)	14" (356)	14 1/16" (357)	4.23 (0.39)	2.73 (0.25)	48 1/2" (1232)	8.75 (0.81)
1636-2	1.66 (0.15)	14" (356)	17 1/16" (433)	5.17 (0.48)	3.31 (0.31)	42 1/2" (1080)	10.23 (0.95)
1640-2	1.95 (0.18)	14" (356)	20 1/16" (509)	6.11 (0.57)	3.90 (0.36)	36 1/2" (927)	11.71 (1.09)
1646-2	2.24 (0.21)	14" (356)	23 1/16" (585)	7.05 (0.66)	4.48 (0.42)	30 1/2" (775)	13.19 (1.23)
1650-2	2.53 (0.24)	14" (356)	26 1/16" (661)	7.98 (0.74)	5.06 (0.47)	24 1/2" (622)	14.67 (1.36)
1656-2	2.82 (0.26)	14" (356)	29 1/16" (738)	8.92 (0.83)	5.65 (0.53)	18 1/2" (470)	16.15 (1.50)
1660-2	3.12 (0.29)	14" (356)	32 1/16" (814)	9.86 (0.92)	6.23 (0.58)	12 1/2" (318)	17.63 (1.64)
2020-2	1.12 (0.10)	20" (508)	8 1/16" (204)	3.62 (0.34)	2.23 (0.21)	60 1/2" (1537)	7.75 (0.72)
2026-2	1.53 (0.14)	20" (508)	11 1/16" (280)	5.05 (0.47)	3.07 (0.29)	54 1/2" (1384)	9.73 (0.90)
2030-2	1.95 (0.18)	20" (508)	14 1/16" (357)	6.49 (0.60)	3.90 (0.36)	48 1/2" (1232)	11.71 (1.09)
2036-2	2.37 (0.22)	20" (508)	17 1/16" (433)	7.93 (0.74)	4.73 (0.44)	42 1/2" (1080)	13.69 (1.27)
2040-2	2.78 (0.26)	20" (508)	20 1/16" (509)	9.37 (0.87)	5.57 (0.52)	36 1/2" (927)	15.67 (1.46)
2046-2	3.20 (0.30)	20" (508)	23 1/16" (585)	10.80 (1.00)	6.40 (0.60)	30 1/2" (775)	17.65 (1.64)
2050-2	3.62 (0.34)	20" (508)	26 1/16" (661)	12.24 (1.14)	7.23 (0.67)	24 1/2" (622)	19.63 (1.82)
2056-2	4.03 (0.38)	20" (508)	29 1/16" (738)	13.68 (1.27)	8.07 (0.75)	18 1/2" (470)	21.61 (2.01)
2060-2	4.45 (0.41)	20" (508)	32 1/16" (814)	15.12 (1.40)	8.90 (0.83)	12 1/2" (318)	23.59 (2.19)
2620-2	1.45 (0.14)	26" (660)	8 1/16" (204)	4.87 (0.45)	2.90 (0.27)	60 1/2" (1537)	9.71 (0.90)
2626-2	1.99 (0.19)	26" (660)	11 1/16" (280)	6.81 (0.63)	3.99 (0.37)	54 1/2" (1384)	12.19 (1.13)
2630-2	2.54 (0.24)	26" (660)	14 1/16" (357)	8.75 (0.81)	5.07 (0.47)	48 1/2" (1232)	14.67 (1.36)
2636-2	3.08 (0.29)	26" (660)	17 1/16" (433)	10.69 (0.99)	6.15 (0.57)	42 1/2" (1080)	17.15 (1.59)
2640-2	3.62 (0.34)	26" (660)	20 1/16" (509)	12.62 (1.17)	7.24 (0.67)	36 1/2" (927)	19.63 (1.82)
2646-2	4.16 (0.39)	26" (660)	23 1/16" (585)	14.56 (1.35)	8.32 (0.77)	30 1/2" (775)	22.11 (2.05)
2650-2	4.70 (0.44)	26" (660)	26 1/16" (661)	16.50 (1.53)	9.40 (0.87)	24 1/2" (622)	24.59 (2.28)
2656-2	5.24 (0.49)	26" (660)	29 1/16" (738)	18.44 (1.71)	10.49 (0.97)	18 1/2" (470)	27.06 (2.51)
2660-2	5.79 (0.54)	26" (660)	32 1/16" (814)	20.37 (1.89)	11.57 (1.08)	12 1/2" (318)	29.54 (2.75)
3020-2	1.79 (0.17)	32" (813)	8 1/16" (204)	6.13 (0.57)	3.57 (0.33)	60 1/2" (1537)	11.67 (1.08)
3026-2	2.45 (0.23)	32" (813)	11 1/16" (280)	8.57 (0.80)	4.91 (0.46)	54 1/2" (1384)	14.65 (1.36)
3030-2	3.12 (0.29)	32" (813)	14 1/16" (357)	11.01 (1.02)	6.24 (0.58)	48 1/2" (1232)	17.63 (1.64)
3036-2	3.79 (0.35)	32" (813)	17 1/16" (433)	13.44 (1.25)	7.57 (0.70)	42 1/2" (1080)	20.61 (1.91)
3040-2	4.45 (0.41)	32" (813)	20 1/16" (509)	15.88 (1.48)	8.91 (0.83)	36 1/2" (927)	23.59 (2.19)
3046-2	5.12 (0.48)	32" (813)	23 1/16" (585)	18.32 (1.70)	10.24 (0.95)	30 1/2" (775)	26.56 (2.47)
3050-2	5.79 (0.54)	32" (813)	26 1/16" (661)	20.76 (1.93)	11.57 (1.08)	24 1/2" (622)	29.54 (2.75)
3056-2	6.45 (0.60)	32" (813)	29 1/16" (738)	23.19 (2.16)	12.91 (1.20)	18 1/2" (470)	32.52 (3.02)
3060-2	7.12 (0.66)	32" (813)	32 1/16" (814)	25.63 (2.38)	14.24 (1.32)	12 1/2" (318)	35.50 (3.30)
3620-2	2.12 (0.20)	38" (965)	8 1/16" (204)	7.39 (0.69)	4.24 (0.39)	60 1/2" (1537)	13.63 (1.27)
3626-2	2.91 (0.27)	38" (965)	11 1/16" (280)	10.33 (0.96)	5.83 (0.54)	54 1/2" (1384)	17.11 (1.59)
3630-2	3.71 (0.34)	38" (965)	14 1/16" (357)	13.26 (1.23)	7.41 (0.69)	48 1/2" (1232)	20.59 (1.91)
3636-2	4.50 (0.42)	38" (965)	17 1/16" (433)	16.20 (1.51)	8.99 (0.84)	42 1/2" (1080)	24.06 (2.24)
3640-2	5.29 (0.49)	38" (965)	20 1/16" (509)	19.14 (1.78)	10.58 (0.98)	36 1/2" (927)	27.54 (2.56)
3646-2	6.08 (0.57)	38" (965)	23 1/16" (585)	22.08 (2.05)	12.16 (1.13)	30 1/2" (775)	31.02 (2.88)
3650-2	6.87 (0.64)	38" (965)	26 1/16" (661)	25.01 (2.32)	13.74 (1.28)	24 1/2" (622)	34.50 (3.21)
3656-2	7.66 (0.71)	38" (965)	29 1/16" (738)	27.95 (2.60)	15.33 (1.42)	18 1/2" (470)	37.98 (3.53)
3660-2	8.46 (0.79)	38" (965)	32 1/16" (814)	30.89 (2.87)	16.91 (1.57)	12 1/2" (318)	41.46 (3.85)
4020-2	2.46 (0.23)	44" (1118)	8 1/16" (204)	8.65 (0.80)	4.91 (0.46)	60 1/2" (1537)	15.59 (1.45)
4026-2	3.37 (0.31)	44" (1118)	11 1/16" (280)	12.08 (1.12)	6.75 (0.63)	54 1/2" (1384)	19.56 (1.82)
4030-2	4.29 (0.40)	44" (1118)	14 1/16" (357)	15.52 (1.44)	8.58 (0.80)	48 1/2" (1232)	23.54 (2.19)
4036-2	5.21 (0.48)	44" (1118)	17 1/16" (433)	18.96 (1.76)	10.41 (0.97)	42 1/2" (1080)	27.52 (2.56)
4040-2	6.12 (0.57)	44" (1118)	20 1/16" (509)	22.40 (2.08)	12.25 (1.14)	36 1/2" (927)	31.50 (2.93)
4046-2	7.04 (0.65)	44" (1118)	23 1/16" (585)	25.83 (2.40)	14.08 (1.31)	30 1/2" (775)	35.48 (3.30)
4050-2	7.96 (0.74)	44" (1118)	26 1/16" (661)	29.27 (2.72)	15.91 (1.48)	24 1/2" (622)	39.46 (3.67)
4056-2	8.87 (0.82)	44" (1118)	29 1/16" (738)	32.71 (3.04)	17.75 (1.65)	18 1/2" (470)	43.44 (4.04)
4060-2	9.79 (0.91)	44" (1118)	32 1/16" (814)	36.15 (3.36)	19.58 (1.82)	12 1/2" (318)	47.42 (4.41)

• "Top of Subfloor to Top of Inside Sill Stop" is calculated based upon a structural header height of 6'-10 1/2" (2096).
 • Dimensions in parentheses are in millimeters or square meters.
 ♦ Meet or exceed clear opening area of 5.7 sq.ft. or 0.53 m², clear opening width of 20" (508) and clear opening height of 24" (610).

100 Series
Single-Hung Windows

SINGLE-HUNG WINDOWS

Table of Sizes for Picture Window with Flanking 26-Wide Single-Hungs

Scale 1/8" (3) = 1'-0" (305) – 1:96

Window Dimension	7'-11 1/2" (2426)	8'-5 1/2" (2578)	8'-11 1/2" (2731)	9'-5 1/2" (2883)	9'-11 1/2" (3035)
Minimum Rough Opening	8'-0" (2438)	8'-6" (2591)	9'-0" (2743)	9'-6" (2896)	10'-0" (3048)
Unobstructed Glass (center sash only)	29 1/4" (743)	35 1/4" (895)	41 1/4" (1048)	47 1/4" (1200)	53 1/4" (1353)

11 1/2" (292)	1'-0" (305)	5 1/4" (133)					
1'-5 1/2" (445)	1'-6" (457)	11 1/4" (286)					
1'-11 1/2" (597)	2'-0" (610)	17 1/4" (438)					
3'-11 1/2" (1207)	4'-0" (1219)	41 1/4" (1048)					
4'-5 1/2" (1359)	4'-6" (1372)	47 1/4" (1200)					
4'-11 1/2" (1511)	5'-0" (1524)	53 1/4" (1353)					
5'-5 1/2" (1664)	5'-6" (1676)	59 1/4" (1505)					
5'-11 1/2" (1816)	6'-0" (1829)	65 1/4" (1657)					

Windows have one continuous outer frame.

Unobstructed glass width dimension of flanking sash is 23 1/4" (591). For unobstructed glass height dimensions of flanking single-hungs, see page 32.

Matching transoms are also shown.

Details shown on pages 48-51.

Grille patterns shown on page 47.

* "Window Dimension" always refers to outside frame to frame dimension.

* "Minimum Rough Opening" dimensions may need to be increased to allow for use of building wraps, flashing, sill panning, brackets, fasteners or other items. See page 109 for more details.

* Dimensions in parentheses are in millimeters.

⊕ Meet or exceed clear opening area of 5.7 sq.ft. or 0.53 m², clear opening width of 20" (508) and clear opening height of 24" (610).

See notes on previous page.

Triple Single-Hung Window Opening and Area Specifications

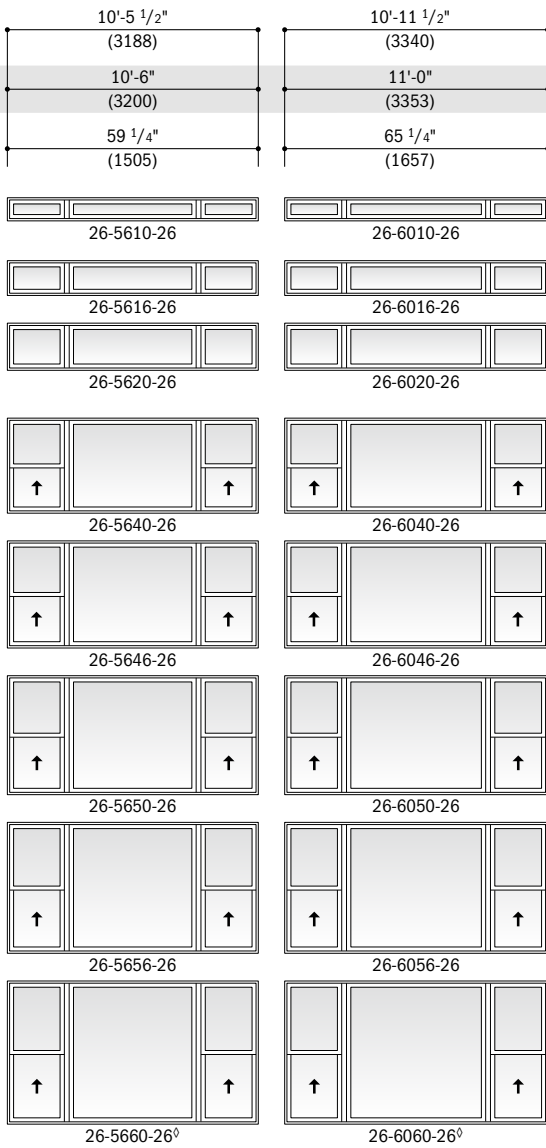

Window Number	Clear Opening Area Sq. Ft./ (m ²)	Clear Opening in Full Open Position		Glass Area Sq. Ft./ (m ²)	Vent Area Sq. Ft./ (m ²)	Top of Subfloor to Top of Inside Sill Stop Inches/ (mm)	Overall Window Area Sq. Ft./ (m ²)
		Width Inches/ (mm)	Height Inches/ (mm)				
1620-3	0.78 (0.07)	14" (356)	8 1/16" (204)	3.54 (0.33)	2.35 (0.22)	60 1/2" (1537)	8.73 (0.81)
1626-3	1.07 (0.10)	14" (356)	11 1/16" (280)	4.94 (0.46)	3.22 (0.30)	54 1/2" (1384)	10.96 (1.02)
1630-3	1.37 (0.13)	14" (356)	14 1/16" (357)	6.35 (0.59)	4.10 (0.38)	48 1/2" (1232)	13.19 (1.23)
1636-3	1.66 (0.15)	14" (356)	17 1/16" (433)	7.76 (0.72)	4.97 (0.46)	42 1/2" (1080)	15.42 (1.43)
1640-3	1.95 (0.18)	14" (356)	20 1/16" (509)	9.16 (0.85)	5.85 (0.54)	36 1/2" (927)	17.65 (1.64)
1646-3	2.24 (0.21)	14" (356)	23 1/16" (585)	10.57 (0.98)	6.72 (0.62)	30 1/2" (775)	19.88 (1.85)
1650-3	2.53 (0.24)	14" (356)	26 1/16" (661)	11.97 (1.11)	7.60 (0.71)	24 1/2" (622)	22.11 (2.05)
1656-3	2.82 (0.26)	14" (356)	29 1/16" (738)	13.38 (1.24)	8.47 (0.79)	18 1/2" (470)	24.34 (2.26)
1660-3	3.12 (0.29)	14" (356)	32 1/16" (814)	14.79 (1.37)	9.35 (0.87)	12 1/2" (318)	26.56 (2.47)
2020-3	1.12 (0.10)	20" (508)	8 1/16" (204)	5.42 (0.50)	3.35 (0.31)	60 1/2" (1537)	11.67 (1.08)
2026-3	1.53 (0.14)	20" (508)	11 1/16" (280)	7.58 (0.70)	4.60 (0.43)	54 1/2" (1384)	14.65 (1.36)
2030-3	1.95 (0.18)	20" (508)	14 1/16" (357)	9.74 (0.90)	5.85 (0.54)	48 1/2" (1232)	17.63 (1.64)
2036-3	2.37 (0.22)	20" (508)	17 1/16" (433)	11.89 (1.11)	7.10 (0.66)	42 1/2" (1080)	20.61 (1.91)
2040-3	2.78 (0.26)	20" (508)	20 1/16" (509)	14.05 (1.31)	8.35 (0.78)	36 1/2" (927)	23.59 (2.19)
2046-3	3.20 (0.30)	20" (508)	23 1/16" (585)	16.20 (1.51)	9.60 (0.89)	30 1/2" (775)	26.56 (2.47)
2050-3	3.62 (0.34)	20" (508)	26 1/16" (661)	18.36 (1.71)	10.85 (1.01)	24 1/2" (622)	29.54 (2.75)
2056-3	4.03 (0.38)	20" (508)	29 1/16" (738)	20.52 (1.91)	12.10 (1.12)	18 1/2" (470)	32.52 (3.02)
2060-3	4.45 (0.41)	20" (508)	32 1/16" (814)	22.67 (2.11)	13.35 (1.24)	12 1/2" (318)	35.50 (3.30)
2620-3	1.45 (0.14)	26" (660)	8 1/16" (204)	7.31 (0.68)	4.35 (0.41)	60 1/2" (1537)	14.61 (1.36)
2626-3	1.99 (0.19)	26" (660)	11 1/16" (280)	10.22 (0.95)	5.98 (0.56)	54 1/2" (1384)	18.34 (1.70)
2630-3	2.54 (0.24)	26" (660)	14 1/16" (357)	13.12 (1.22)	7.60 (0.71)	48 1/2" (1232)	22.06 (2.05)
2636-3	3.08 (0.29)	26" (660)	17 1/16" (433)	16.03 (1.49)	9.23 (0.86)	42 1/2" (1080)	25.79 (2.40)
2640-3	3.62 (0.34)	26" (660)	20 1/16" (509)	18.93 (1.76)	10.85 (1.01)	36 1/2" (927)	29.52 (2.74)
2646-3	4.16 (0.39)	26" (660)	23 1/16" (585)	21.84 (2.03)	12.48 (1.16)	30 1/2" (775)	33.25 (3.09)
2650-3	4.70 (0.44)	26" (660)	26 1/16" (661)	24.75 (2.30)	14.10 (1.31)	24 1/2" (622)	36.98 (3.44)
2656-3	5.24 (0.49)	26" (660)	29 1/16" (738)	27.65 (2.57)	15.73 (1.46)	18 1/2" (470)	40.71 (3.78)
2660-3	5.79 (0.54)	26" (660)	32 1/16" (814)	30.56 (2.84)	17.35 (1.61)	12 1/2" (318)	44.44 (4.13)
3020-3	1.79 (0.17)	32" (813)	8 1/16" (204)	9.20 (0.85)	5.36 (0.50)	60 1/2" (1537)	17.54 (1.63)
3026-3	2.45 (0.23)	32" (813)	11 1/16" (280)	12.85 (1.19)	7.36 (0.68)	54 1/2" (1384)	22.02 (2.05)
3030-3	3.12 (0.29)	32" (813)	14 1/16" (357)	16.51 (1.53)	9.36 (0.87)	48 1/2" (1232)	26.50 (2.46)
3036-3	3.79 (0.35)	32" (813)	17 1/16" (433)	20.16 (1.87)	11.36 (1.06)	42 1/2" (1080)	30.98 (2.88)
3040-3	4.45 (0.41)	32" (813)	20 1/16" (509)	23.82 (2.21)	13.36 (1.24)	36 1/2" (927)	35.46 (3.29)
3046-3	5.12 (0.48)	32" (813)	23 1/16" (585)	27.48 (2.55)	15.36 (1.43)	30 1/2" (775)	39.94 (3.71)
3050-3	5.79 (0.54)	32" (813)	26 1/16" (661)	31.13 (2.89)	17.36 (1.61)	24 1/2" (622)	44.42 (4.13)
3056-3	6.45 (0.60)	32" (813)	29 1/16" (738)	34.79 (3.23)	19.36 (1.80)	18 1/2" (470)	48.90 (4.54)
3060-3	7.12 (0.66)	32" (813)	32 1/16" (814)	38.45 (3.57)	21.36 (1.98)	12 1/2" (318)	53.38 (4.96)
3620-3	2.12 (0.20)	38" (965)	8 1/16" (204)	11.08 (1.03)	6.36 (0.59)	60 1/2" (1537)	20.48 (1.90)
3626-3	2.91 (0.27)	38" (965)	11 1/16" (280)	15.49 (1.44)	8.74 (0.81)	54 1/2" (1384)	25.71 (2.39)
3630-3	3.71 (0.34)	38" (965)	14 1/16" (357)	19.89 (1.85)	11.11 (1.03)	48 1/2" (1232)	30.94 (2.87)
3636-3	4.50 (0.42)	38" (965)	17 1/16" (433)	24.30 (2.26)	13.49 (1.25)	42 1/2" (1080)	36.17 (3.36)
3640-3	5.29 (0.49)	38" (965)	20 1/16" (509)	28.71 (2.67)	15.86 (1.47)	36 1/2" (927)	41.40 (3.85)
3646-3	6.08 (0.57)	38" (965)	23 1/16" (585)	33.11 (3.08)	18.24 (1.69)	30 1/2" (775)	46.63 (4.33)
3650-3	6.87 (0.64)	38" (965)	26 1/16" (661)	37.52 (3.49)	20.61 (1.92)	24 1/2" (622)	51.86 (4.82)
3656-3	7.66 (0.71)	38" (965)	29 1/16" (738)	41.93 (3.90)	22.99 (2.14)	18 1/2" (470)	57.09 (5.30)
3660-3	8.46 (0.79)	38" (965)	32 1/16" (814)	46.33 (4.30)	25.36 (2.36)	12 1/2" (318)	62.31 (5.79)
4020-3	2.46 (0.23)	44" (1118)	8 1/16" (204)	12.97 (1.21)	7.37 (0.69)	60 1/2" (1537)	23.42 (2.18)
4026-3	3.37 (0.31)	44" (1118)	11 1/16" (280)	18.12 (1.68)	10.12 (0.94)	54 1/2" (1384)	29.40 (2.73)
4030-3	4.29 (0.40)	44" (1118)	14 1/16" (357)	23.28 (2.16)	12.87 (1.20)	48 1/2" (1232)	35.38 (3.29)
4036-3	5.21 (0.48)	44" (1118)	17 1/16" (433)	28.44 (2.64)	15.62 (1.45)	42 1/2" (1080)	41.36 (3.84)
4040-3	6.12 (0.57)	44" (1118)	20 1/16" (509)	33.59 (3.12)	18.37 (1.71)	36 1/2" (927)	47.34 (4.40)
4046-3	7.04 (0.65)	44" (1118)	23 1/16" (585)	38.75 (3.60)	21.12 (1.96)	30 1/2" (775)	53.31 (4.95)
4050-3	7.96 (0.74)	44" (1118)	26 1/16" (661)	43.91 (4.08)	23.87 (2.22)	24 1/2" (622)	59.29 (5.51)
4056-3	8.87 (0.82)	44" (1118)	29 1/16" (738)	49.06 (4.56)	26.62 (2.47)	18 1/2" (470)	65.27 (6.06)
4060-3	9.79 (0.91)	44" (1118)	32 1/16" (814)	54.22 (5.04)	29.37 (2.73)	12 1/2" (318)	71.25 (6.62)

Top of Subfloor to Top of Inside Sill Stop is calculated based upon a structural header height of 6'-10 1/2" (2096).
 *Dimensions in parentheses are in millimeters or square meters.
 ◊Meet or exceed clear opening area of 5.7 sq.ft. or 0.53 m², clear opening width of 20" (508) and clear opening height of 24" (610).

100 Series
Single-Hung Windows

SINGLE-HUNG WINDOWS

Table of Sizes for Picture Window with Flanking 30-Wide Single-Hungs

Scale 1/8" (3) = 1'-0" (305) – 1:96

Window Dimension	8'-11 1/2" (2731)	9'-5 1/2" (2883)	9'-11 1/2" (3035)	10'-5 1/2" (3188)
Minimum Rough Opening	9'-0" (2743)	9'-6" (2896)	10'-0" (3048)	10'-6" (3200)
Unobstructed Glass (center sash only)	29 1/4" (743)	35 1/4" (895)	41 1/4" (1048)	47 1/4" (1200)

11 1/2" (292)	1'-0" (305)	5 1/4" (133)				
1'-5 1/2" (445)	1'-6" (457)	11 1/4" (286)				
1'-11 1/2" (597)	2'-0" (610)	17 1/4" (438)				
3'-11 1/2" (1207)	4'-0" (1219)	41 1/4" (1048)				
4'-5 1/2" (1359)	4'-6" (1372)	47 1/4" (1200)				
4'-11 1/2" (1511)	5'-0" (1524)	53 1/4" (1353)				
5'-5 1/2" (1664)	5'-6" (1676)	59 1/4" (1505)				
5'-11 1/2" (1816)	6'-0" (1829)	65 1/4" (1657)				

* "Window Dimension" always refers to outside frame to frame dimension.

* "Minimum Rough Opening" dimensions may need to be increased to allow for use of building wraps, flashing, sill panning, brackets, fasteners or other items. See page 109 for more details.

* Dimensions in parentheses are in millimeters.

◊ Meet or exceed clear opening area of 5.7 sq.ft. or 0.53 m², clear opening width of 20" (508) and clear opening height of 24" (610).

Notes on this page also apply to previous page.

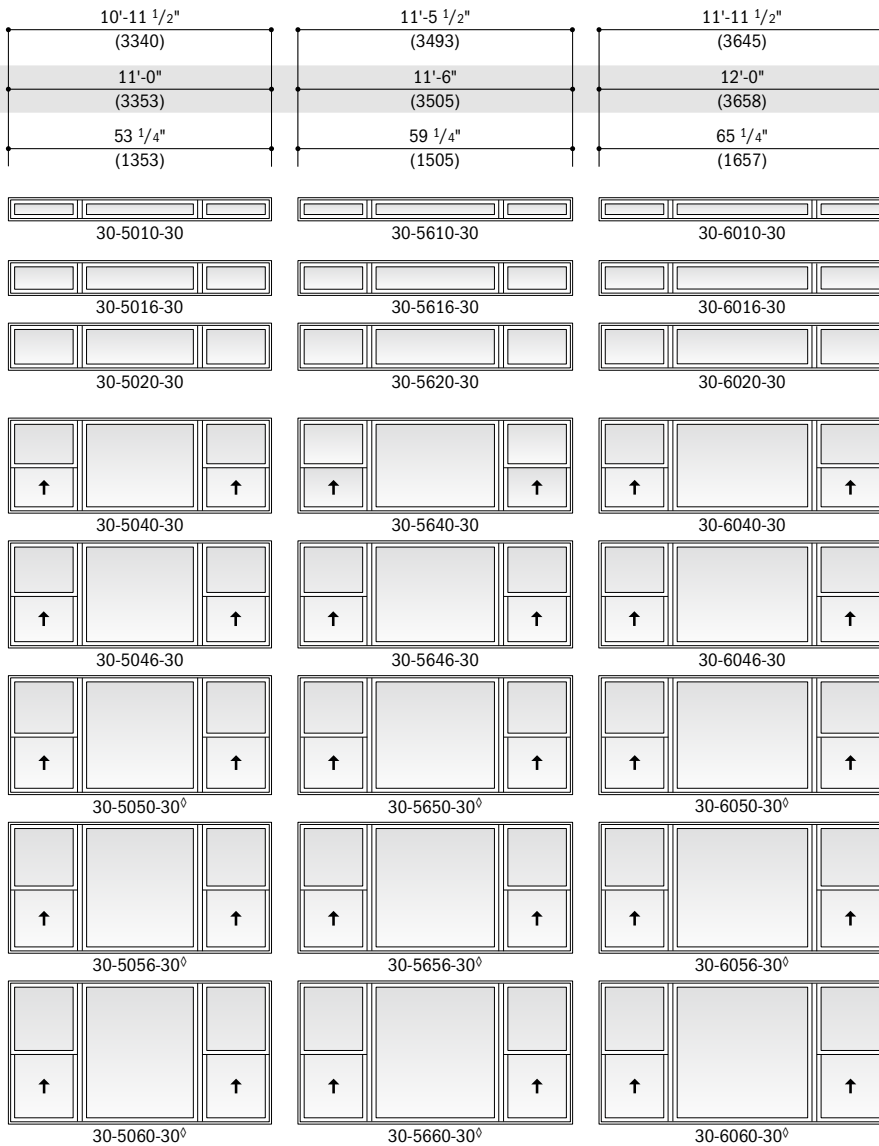

Windows have one continuous outer frame.

Unobstructed glass width dimension of flanking sash is 29 1/4" (743). For unobstructed glass height dimensions of flanking single-hungs, see page 32.

Matching transoms are also shown.

Details shown on pages 48-51.

Grille patterns shown below.

- "Window Dimension" always refers to outside frame to frame dimension.
- "Minimum Rough Opening" dimensions may need to be increased to allow for use of building wraps, flashing, sill panning, brackets, fasteners or other items. See page 109 for more details.
- Dimensions in parentheses are in millimeters.
- Meet or exceed clear opening area of 5.7 sq.ft. or 0.53 m², clear opening width of 20" (508) and clear opening height of 24" (610).

100 Series Single-Hung Windows

Grille Patterns

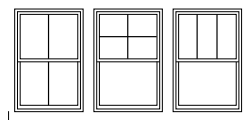
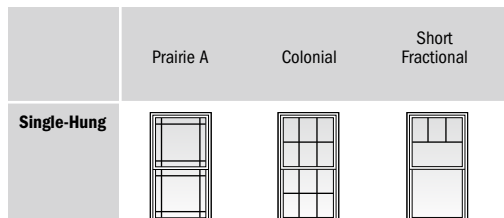

Specified Equal Light Examples

Single-hung window patterns are also available in Upper Sash Only (USO) configurations.

For picture window patterns that require alignment with single-hung patterns, identify the single-hung sash style (equal or reverse cottage) when ordering.

Number of lights and overall pattern varies with window size. Patterns shown may not be available for all sizes. Specified equal light pattern is also available. For more information on divided light, see page 13 or visit andersenwindows.com/grilles.

SINGLE-HUNG WINDOWS

Arch Single-Hung Window Details - New Construction

Scale 1 1/2" (38) = 1'-0" (305) - 1:8

1 3/8" flange setback

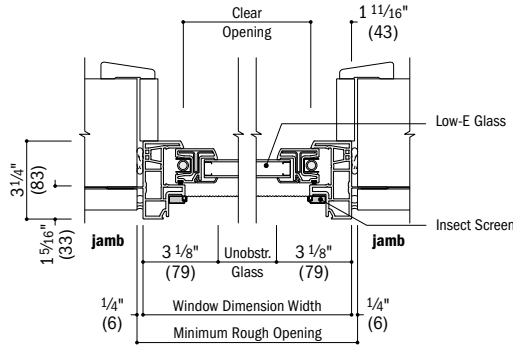

Horizontal Section
Arch Single-Hung

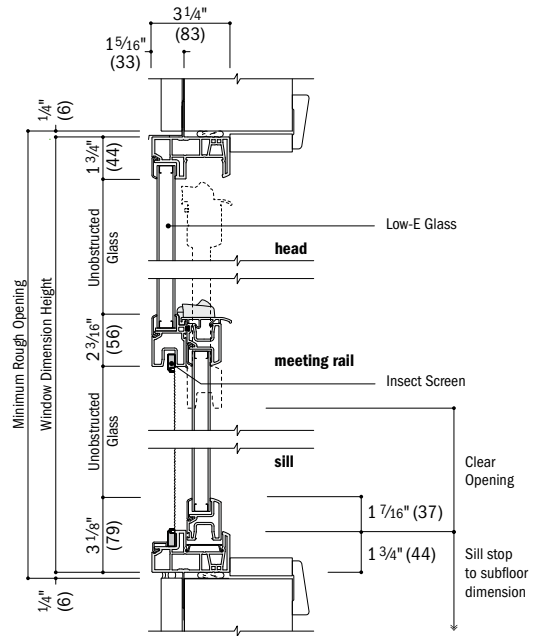

Vertical Section
Arch Single-Hung

1" flange setback with stucco key

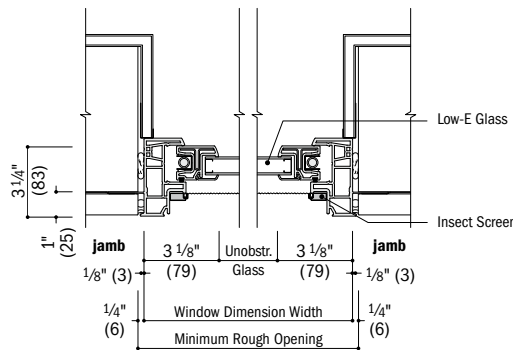

Horizontal Section
Arch Single-Hung - stucco exterior

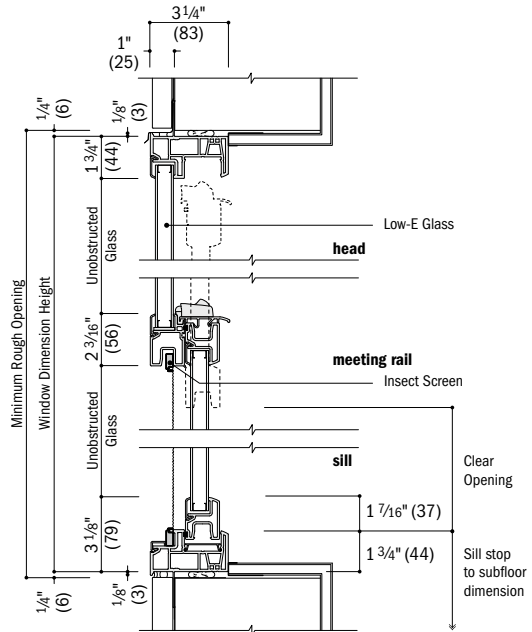

Vertical Section
Arch Single-Hung - stucco exterior

- Drip cap is required to complete window installation as shown, but may not be included with the window. Use of drip cap is recommended for proper installation.
- Light-colored areas are parts included with window. Dark-colored areas are additional Andersen® parts required to complete window assembly as shown.
- **Rough openings may need to be increased to allow for use of building wraps, flashing, sill panning, brackets, fasteners or other items. See installation information on page 109.**
- Details are for illustration only and are not intended to represent product installation methods or materials. Refer to product installation guides at andersenwindows.com.
- Dimensions in parentheses are in millimeters.

Arch Single-Hung Window Details – Replacement

Scale 1 1/2" (38) = 1'-0" (305) – 1:8

no flange

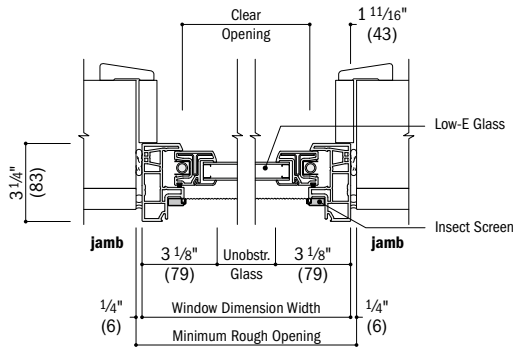

Horizontal Section
existing framed opening

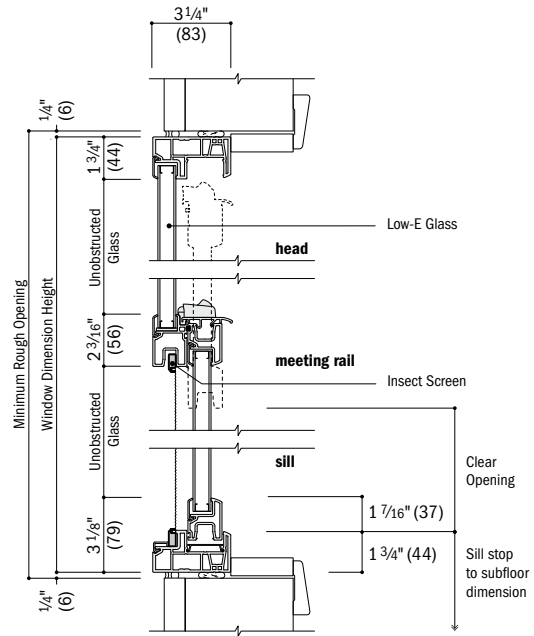

Vertical Section
existing framed opening

100 Series
Single-Hung Windows

- Drip cap is required to complete window installation as shown, but may not be included with the window. Use of drip cap is recommended for proper installation.
- Light-colored areas are parts included with window. Dark-colored areas are additional Andersen[®] parts required to complete window assembly as shown.
- **Rough openings may need to be increased to allow for use of building wraps, flashing, sill panning, brackets, fasteners or other items. See installation information on page 109.**
- Details are for illustration only and are not intended to represent product installation methods or materials. Refer to product installation guides at andersenwindows.com.
- Dimensions in parentheses are in millimeters.

SINGLE-HUNG WINDOWS

Single-Hung Window Details – New Construction

Scale 1 1/2" (38) = 1'-0" (305) – 1:8

1 3/8" flange setback

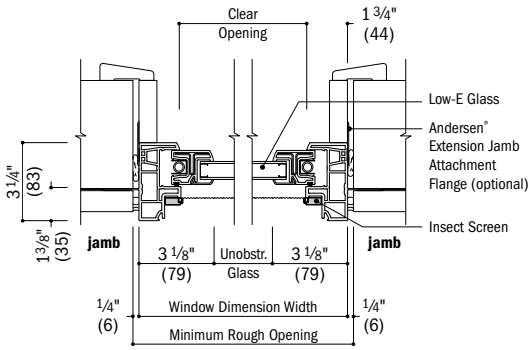

Horizontal Section

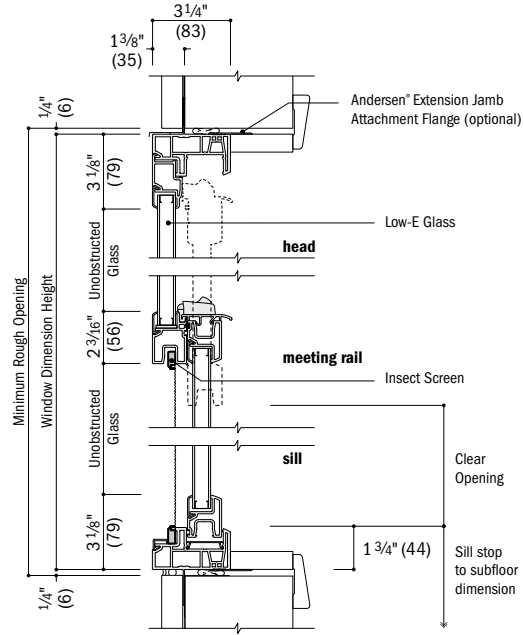

Vertical Section

1" flange setback with stucco key

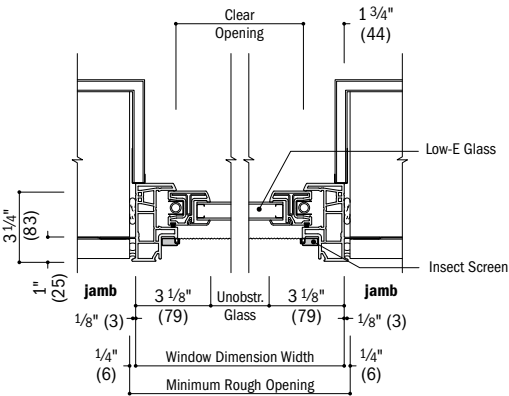

Horizontal Section
stucco exterior

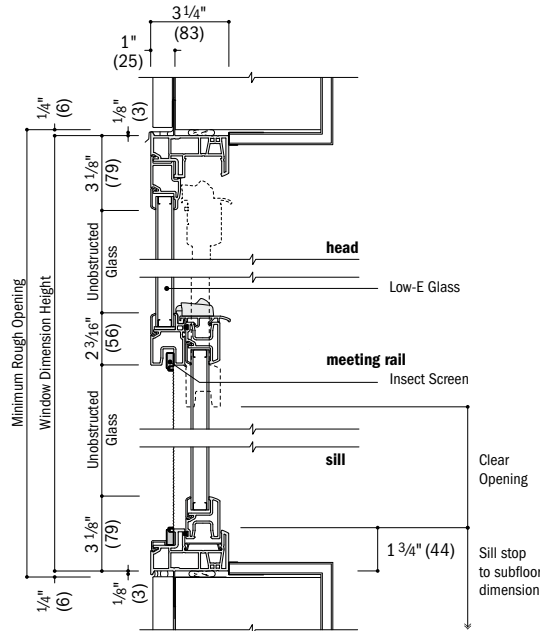

Vertical Section
stucco exterior

See pages 84-87 for horizontal and vertical joining details.

integrals

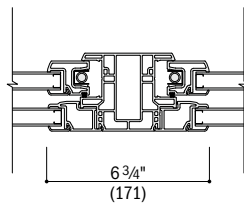

Horizontal Section
Twin or Triple Single-Hung

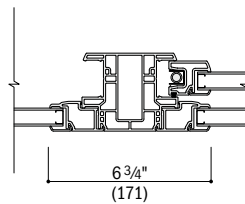

Horizontal Section
Picture with Flanking Single-Hung

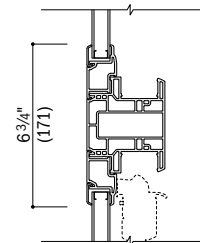

Vertical Section
Transom over Single-Hung

- Drip cap is required to complete window installation as shown, but may not be included with the window. Use of drip cap is recommended for proper installation.
- Light-colored areas are parts included with window. Dark-colored areas are additional Andersen® parts required to complete window assembly as shown.
- **Rough openings may need to be increased to allow for use of building wraps, flashing, sill panning, brackets, fasteners or other items. See installation information on page 109.**
- Details are for illustration only and are not intended to represent product installation methods or materials. Refer to product installation guides at andersenwindows.com.
- Dimensions in parentheses are in millimeters.

Single-Hung Window Details – Replacement

Scale 1 1/2" (38) = 1'-0" (305) – 1:8

no flange

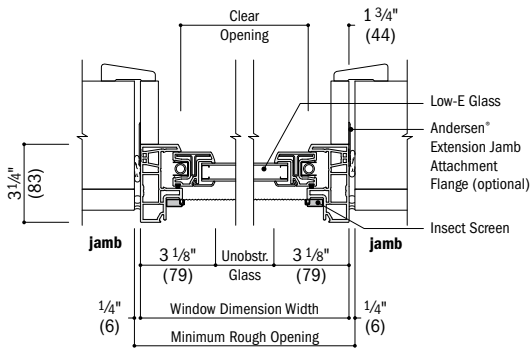

Horizontal Section
existing framed opening

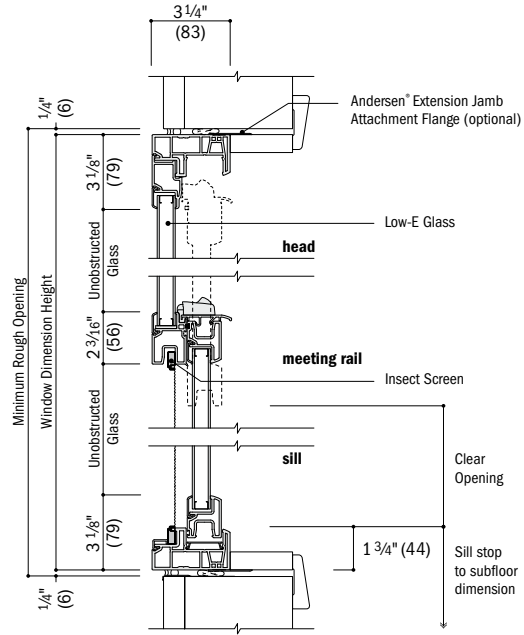

Vertical Section
existing framed opening

insert

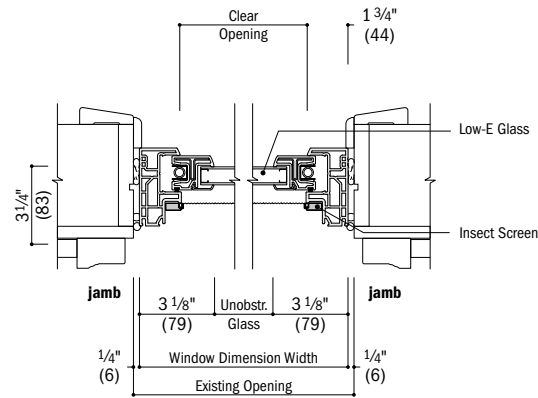

Horizontal Section
existing window opening

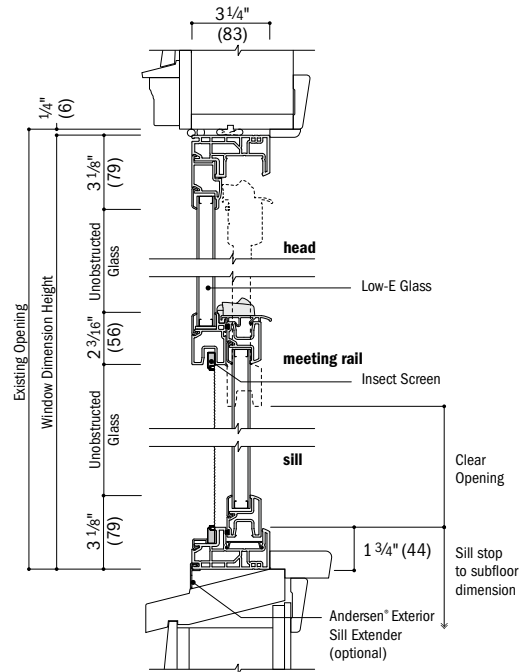

Vertical Section
existing window opening

Installation accessories for insert frame shown on page 108.

See pages 84-87 for horizontal and vertical joining details.

- Drip cap is required to complete window installation as shown, but may not be included with the window. Use of drip cap is recommended for proper installation.
- Light-colored areas are parts included with window. Dark-colored areas are additional Andersen® parts required to complete window assembly as shown.
- **Rough openings may need to be increased to allow for use of building wraps, flashing, sill panning, brackets, fasteners or other items. See installation information on page 109.**
- Details are for illustration only and are not intended to represent product installation methods or materials. Refer to product installation guides at andersenwindows.com.
- Dimensions in parentheses are in millimeters.

integrals

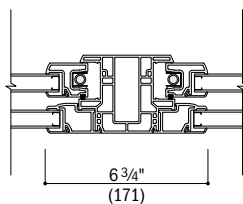

Horizontal Section
Twin or Triple Single-Hung

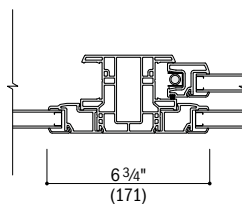

Horizontal Section
Picture with Flanking Single-Hung

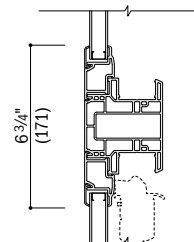

Vertical Section
Transom over Single-Hung

100 Series
Single-Hung Windows

GLIDING WINDOWS

Table of Gliding Window Sizes – Active-Stationary or Stationary-Active (XO/OX)

Scale 1/8" (3) = 1'-0" (305) – 1:96

Window Dimension	1'-11 1/2"	2'-5 1/2"	2'-11 1/2"	3'-5 1/2"	3'-11 1/2"	4'-5 1/2"	4'-11 1/2"	5'-5 1/2"	5'-11 1/2"
	(597)	(749)	(902)	(1054)	(1207)	(1359)	(1511)	(1664)	(1816)
Minimum Rough Opening	2'-0"	2'-6"	3'-0"	3'-6"	4'-0"	4'-6"	5'-0"	5'-6"	6'-0"
	(610)	(762)	(914)	(1067)	(1219)	(1372)	(1524)	(1676)	(1829)
Unobstructed Glass (width of single sash)	7 9/16"	10 9/16"	13 9/16"	16 9/16"	19 9/16"	22 9/16"	25 9/16"	28 9/16"	31 9/16"
	(192)	(268)	(344)	(420)	(496)	(573)	(649)	(725)	(801)

CUSTOM WIDTHS – 23 1/2" to 71 1/2"

CUSTOM HEIGHTS – 11 1/2" to 71 1/2"	CUSTOM WIDTHS – 23 1/2" to 71 1/2"								
	2010	2610	3010	3610	4010	4610	5010	5610	6010
11 1/2" (292)									
1'-5 1/2" (445)									
1'-11 1/2" (597)									
2'-5 1/2" (749)									
2'-11 1/2" (902)									
3'-5 1/2" (1054)									
3'-11 1/2" (1207)									
4'-5 1/2" (1359)									
4'-11 1/2" (1511)									
5'-5 1/2" (1664)									
5'-11 1/2" (1816)									



Custom-size windows are available in 1/8" (3) increments. See page 90 for custom sizes and specifications.

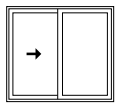

Active-Stationary

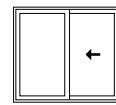

Stationary-Active

Choose active-stationary (XO) or stationary-active (OX) as viewed from the exterior. Two locks are standard on all heights greater than 4'-2" (1270). Details shown on pages 64-65. Grille patterns shown on page 63.

• "Window Dimension" always refers to outside frame to frame dimension.
 • "Minimum Rough Opening" dimensions may need to be increased to allow for use of building wraps, flashing, sill panning, brackets, fasteners or other items. See page 109 for more details.
 • Dimensions in parentheses are in millimeters.
 ◊ Meet or exceed clear opening area of 5.7 sq.ft. or 0.53 m², clear opening width of 20" (508) and clear opening height of 24" (610). See table on pages 58-59.

Table of Sizes for Picture Window over Gliding - Active-Stationary or Stationary-Active (X0/OX)

Scale 1/8" (3) = 1'-0" (305) – 1:96

Window Dimension	2'-11 1/2" (902)	3'-11 1/2" (1207)	4'-11 1/2" (1511)	5'-11 1/2" (1816)
Minimum Rough Opening	3'-0" (914)	4'-0" (1219)	5'-0" (1524)	6'-0" (1829)
Unobstructed Glass (upper sash only)	29 1/4" (743)	41 1/4" (1048)	53 1/4" (1353)	65 1/4" (1657)

4'-11 1/2" (1511)	5'-0" (1524)	35 1/4" (895)				
			3036 3016	4036 4016	5036 5016	6036 6016
5'-11 1/2" (1816)	6'-0" (1829)	41 1/4" (1048)				
			3040 3020	4040 4020	5040 5020	6040 6020
6'-11 1/2" (2121)	7'-0" (2134)	53 1/4" (1353)				
			3050 3020	4050 4020	5050 5020	6050 6020

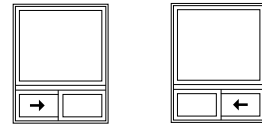

Active-Stationary Stationary-Active

Choose active-stationary (**X0**) or stationary-active (**OX**) as viewed from the exterior. Windows have one continuous outer frame.

For unobstructed glass dimensions of lower sash, see page 52.

Details shown on pages 64-65.

Grille patterns shown on page 63.

- "Window Dimension" always refers to outside frame to frame dimension.
- "Minimum Rough Opening" dimensions may need to be increased to allow for use of building wraps, flashing, sill panning, brackets, fasteners or other items. See page 109 for more details.
- Dimensions in parentheses are in millimeters.

Table of Gliding Window Sizes – Active-Stationary-Active (XOX) 1:2:1 Sash Ratio

Scale 1/8" (3) = 1'-0" (305) – 1:96

Window Dimension	4'-11 1/2" (1511)	5'-11 1/2" (1816)	6'-11 1/2" (2121)	7'-5 1/2" (2273)	7'-11 1/2" (2426)	8'-5 1/2" (2578)
Minimum Rough Opening	5'-0" (1524)	6'-0" (1829)	7'-0" (2134)	7'-6" (2286)	8'-0" (2438)	8'-6" (2591)
Unobstructed Glass (width of center sash)	27 7/8" (708)	33 7/8" (861)	39 7/8" (1013)	42 7/8" (1089)	45 7/8" (1165)	48 7/8" (1242)
Unobstructed Glass (width of single venting sash)	10 17/32" (267)	13 17/32" (344)	16 17/32" (420)	18 17/32" (458)	19 17/32" (496)	21 17/32" (534)

CUSTOM WIDTHS – 59 1/2" to 143 1/2"

CUSTOM HEIGHTS – 17 1/2" to 71 1/2"	CUSTOM WIDTHS – 59 1/2" to 143 1/2"					
	5016	6016	7016	7616	8016	8616
1'-5 1/2" (445)						
1'-11 1/2" (597)						
2'-5 1/2" (749)						
2'-11 1/2" (902)						
3'-5 1/2" (1054)						
3'-11 1/2" (1207)						
4'-5 1/2" (1359)						
4'-11 1/2" (1511)						
5'-5 1/2" (1664)						
5'-11 1/2" (1816)						

* "Window Dimension" always refers to outside frame to frame dimension.
 • "Minimum Rough Opening" dimensions may need to be increased to allow for use of building wraps, flashing, sill panning, brackets, fasteners or other items. See page 109 for more details.
 • Dimensions in parentheses are in millimeters.
 ◊ Meet or exceed clear opening area of 5.7 sq.ft. or 0.53 m², clear opening width of 20" (508) and clear opening height of 24" (610). See table on pages 60-61.

Notes on this page also apply to previous page.

8'-11 1/2" (2731)	9'-11 1/2" (3035)	10'-11 1/2" (3340)	11'-11 1/2" (3645)
9'-0" (2743)	10'-0" (3048)	11'-0" (3353)	12'-0" (3658)
51 7/8" (1318)	57 7/8" (1470)	63 7/8" (1623)	69 7/8" (1775)
22 17/32" (572)	25 17/32" (648)	28 17/32" (725)	31 17/32" (801)



Custom-size windows are available in 1/8" (3) increments. See page 90 for custom sizes and specifications.

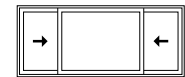
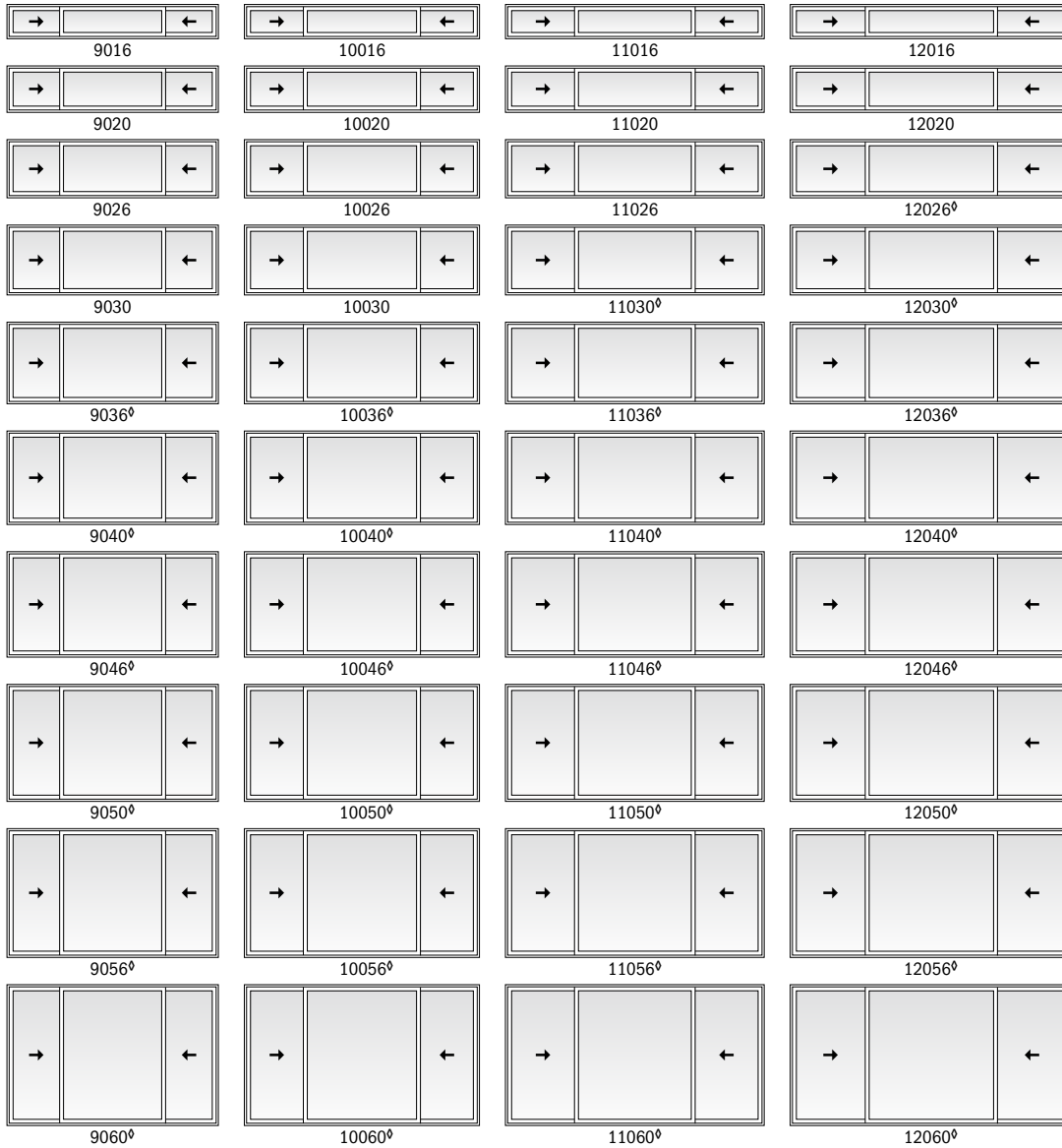

Active-Stationary-Active

Exterior view shown. Sash configuration is active-stationary-active (XOX) with a 1:2:1 sash ratio. Two locks for each sash are standard on all heights greater than 4'-2" (1270).

Details shown on pages 64-65. Grille patterns shown on page 63.

* "Window Dimension" always refers to outside frame to frame dimension.
 * "Minimum Rough Opening" dimensions may need to be increased to allow for use of building wraps, flashing, sill panning, brackets, fasteners or other items. See page 109 for more details.
 • Dimensions in parentheses are in millimeters.
 ◊ Meet or exceed clear opening area of 5.7 sq.ft. or 0.53 m², clear opening width of 20" (508) and clear opening height of 24" (610). See table on pages 60-61.

GLIDING WINDOWS

Table of Sizes for Picture Window over Gliding – Active-Stationary-Active (XOX) 1:2:1 Sash Ratio

Scale 1/8" (3) = 1'-0" (305) – 1:96

Window Dimension	5'-11 1/2" (1816)	6'-11 1/2" (2121)	7'-11 1/2" (2426)	8'-11 1/2" (2731)
Minimum Rough Opening	6'-0" (1829)	7'-0" (2134)	8'-0" (2438)	9'-0" (2743)
Unobstructed Glass (upper sash only)	65 1/4" (1657)	77 1/4" (1962)	89 1/4" (2267)	101 1/4" (2572)

4'-11 1/2" (1511) 5'-0" (1524) 35 1/4" (895)				
	6036 6016	7036 7016	8036 8016	9036 9016
	5'-11 1/2" (1816) 6'-0" (1829) 41 1/4" (1048)			
6040 6020		7040 7020	8040 8020	9040 9020
6'-11 1/2" (2121) 7'-0" (2134) 53 1/4" (1353)				
	6050 6020	7050 7020	8050 8020	9050 9020

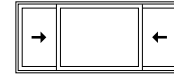

Active-Stationary-Active

Exterior view shown. Lower sash configuration is active-stationary-active (XOX) with a 1:2:1 sash ratio. Windows have one continuous outer frame.

For unobstructed glass dimensions of lower sash, see pages 54-55.

Details shown on pages 64-65.
Grille patterns shown on page 63.

• "Window Dimension" always refers to outside frame to frame dimension.
 • "Minimum Rough Opening" dimensions may need to be increased to allow for use of building wraps, flashing, sill panning, brackets, fasteners or other items. See page 109 for more details.
 • Dimensions in parentheses are in millimeters.

Table of Gliding Window Sizes – Active-Stationary-Active (XOX) 1:1:1 Equal Sash Ratio

Scale 1/8" (3) = 1'-0" (305) – 1:96

Window Dimension	3'-11 1/2"	4'-11 1/2"	5'-11 1/2"	6'-11 1/2"	7'-5 1/2"	7'-11 1/2"	8'-5 1/2"
	(1207)	(1511)	(1816)	(2121)	(2273)	(2426)	(2578)
Minimum Rough Opening	4'-0"	5'-0"	6'-0"	7'-0"	7'-6"	8'-0"	8'-6"
	(1219)	(1524)	(1829)	(2134)	(2286)	(2438)	(2591)
Unobstructed Glass (width of center sash)	12 11/32"	16 11/32"	20 11/32"	24 11/32"	26 11/32"	28 11/32"	30 11/32"
	(313)	(415)	(517)	(618)	(669)	(720)	(771)
Unobstructed Glass (width of single venting sash)	12 9/32"	16 9/32"	20 9/32"	24 9/32"	26 9/32"	28 9/32"	30 9/32"
	(312)	(414)	(516)	(617)	(668)	(719)	(770)

CUSTOM WIDTHS – 47 1/2" to 101 1/2"

CUSTOM HEIGHTS – 17 1/2" to 71 1/2"

Window Dimension	3'-11 1/2"	4'-11 1/2"	5'-11 1/2"	6'-11 1/2"	7'-5 1/2"	7'-11 1/2"	8'-5 1/2"
1'-5 1/2"	4016	5016	6016	7016	7616	8016	8616
1'-11 1/2"	4020	5020	6020	7020	7620	8020	8620
2'-5 1/2"	4026	5026	6026	7026	7626	8026	8626
2'-11 1/2"	4030	5030	6030	7030	7630	8030 ^o	8630 ^o
3'-5 1/2"	4036	5036	6036	7036 ^o	7636 ^o	8036 ^o	8636 ^o
3'-11 1/2"	4040	5040	6040	7040 ^o	7640 ^o	8040 ^o	8640 ^o
4'-5 1/2"	4046	5046	6046	7046 ^o	7646 ^o	8046 ^o	8646 ^o
4'-11 1/2"	4050	5050	6050	7050 ^o	7650 ^o	8050 ^o	8650 ^o
5'-5 1/2"	4056	5056	6056	7056 ^o	7656 ^o	8056 ^o	8656 ^o
5'-11 1/2"	4060	5060	6060	7060 ^o	7660 ^o	8060 ^o	8660 ^o



Custom-size windows are available in 1/8" (3) increments. See page 90 for custom sizes and specifications.

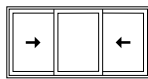

Active-Stationary-Active

Exterior view shown. Sash configuration is active-stationary-active (XOX) with a 1:1:1 equal sash ratio. Two locks are standard on all heights greater than 4'-2" (1270). Grille patterns shown on page 63.

* "Window Dimension" always refers to outside frame to frame dimension.

** "Minimum Rough Opening" dimensions may need to be increased to allow for use of building wraps, flashing, sill panning, brackets, fasteners or other items. See page 109 for more details.

• Dimensions in parentheses are in millimeters.

◊ Meet or exceed clear opening area of 5.7 sq.ft. or 0.53 m², clear opening width of 20" (508) and clear opening height of 24" (610). See table on pages 62-63.

Gliding Window Opening and Area Specifications – Active-Stationary or Stationary-Active (XO/OX) *(continued)*

Window Number	Clear Opening Area Sq. Ft./ (m ²)	Clear Opening in Full Open Position		Total Glass Area Sq. Ft./ (m ²)	Fixed Sash Glass Area Sq. Ft./ (m ²)	Active Sash Glass Area Sq. Ft./ (m ²)	Vent Area Sq. Ft./ (m ²)	Top of Subfloor to Top of Inside Sill Stop Inches/ (mm)	Overall Window Area Sq. Ft./ (m ²)
		Width Inches/ (mm)	Height Inches/ (mm)						
4626	4.16 (0.39)	23 1/16" (585)	26" (660)	7.28 (0.68)	3.64 (0.34)	3.64 (0.34)	4.16 (0.39)	54 1/2" (1384)	10.96 (1.02)
4630	5.12 (0.48)	23 1/16" (585)	32" (813)	9.16 (0.85)	4.58 (0.43)	4.58 (0.43)	5.12 (0.48)	48 1/2" (1232)	13.19 (1.23)
4636 ◊	6.08 (0.56)	23 1/16" (585)	38" (965)	11.04 (1.03)	5.52 (0.51)	5.51 (0.51)	6.08 (0.56)	42 1/2" (1080)	15.42 (1.43)
4640 ◊	7.04 (0.65)	23 1/16" (585)	44" (1118)	12.92 (1.20)	6.46 (0.60)	6.45 (0.60)	7.04 (0.65)	36 1/2" (927)	17.65 (1.64)
4646 ◊	8.00 (0.74)	23 1/16" (585)	50" (1270)	14.80 (1.37)	7.40 (0.69)	7.39 (0.69)	8.00 (0.74)	30 1/2" (775)	19.88 (1.85)
4650 ◊	8.96 (0.83)	23 1/16" (585)	56" (1422)	16.67 (1.55)	8.34 (0.78)	8.33 (0.77)	8.96 (0.83)	24 1/2" (622)	22.11 (2.05)
4656 ◊	9.92 (0.92)	23 1/16" (585)	62" (1575)	18.55 (1.72)	9.28 (0.86)	9.27 (0.86)	9.92 (0.92)	18 1/2" (470)	24.34 (2.26)
4660 ◊	10.88 (1.01)	23 1/16" (585)	68" (1727)	20.43 (1.90)	10.23 (0.95)	10.21 (0.95)	10.88 (1.01)	12 1/2" (318)	26.56 (2.47)
5010	1.45 (0.13)	26 1/16" (661)	8" (203)	1.86 (0.17)	0.93 (0.09)	0.93 (0.09)	1.45 (0.13)	72 1/2" (1842)	4.75 (0.44)
5016	2.53 (0.24)	26 1/16" (661)	14" (356)	3.99 (0.37)	2.00 (0.19)	1.99 (0.19)	2.53 (0.24)	66 1/2" (1689)	7.23 (0.67)
5020	3.62 (0.34)	26 1/16" (661)	20" (508)	6.12 (0.57)	3.06 (0.28)	3.06 (0.28)	3.62 (0.34)	60 1/2" (1537)	9.71 (0.90)
5026	4.70 (0.44)	26 1/16" (661)	26" (660)	8.25 (0.77)	4.13 (0.38)	4.12 (0.38)	4.70 (0.44)	54 1/2" (1384)	12.19 (1.13)
5030 ◊	5.79 (0.54)	26 1/16" (661)	32" (813)	10.38 (0.96)	5.19 (0.48)	5.18 (0.48)	5.79 (0.54)	48 1/2" (1232)	14.67 (1.36)
5036 ◊	6.87 (0.64)	26 1/16" (661)	38" (965)	12.51 (1.16)	6.26 (0.58)	6.25 (0.58)	6.87 (0.64)	42 1/2" (1080)	17.15 (1.59)
5040 ◊	7.96 (0.74)	26 1/16" (661)	44" (1118)	14.64 (1.36)	7.32 (0.68)	7.31 (0.68)	7.96 (0.74)	36 1/2" (927)	19.63 (1.82)
5046 ◊	9.04 (0.84)	26 1/16" (661)	50" (1270)	16.76 (1.56)	8.39 (0.78)	8.38 (0.78)	9.04 (0.84)	30 1/2" (775)	22.11 (2.05)
5050 ◊	10.13 (0.94)	26 1/16" (661)	56" (1422)	18.89 (1.76)	9.45 (0.88)	9.44 (0.88)	10.13 (0.94)	24 1/2" (622)	24.59 (2.28)
5056 ◊	11.21 (1.04)	26 1/16" (661)	62" (1575)	21.02 (1.95)	10.52 (0.98)	10.50 (0.98)	11.21 (1.04)	18 1/2" (470)	27.06 (2.51)
5060 ◊	12.30 (1.14)	26 1/16" (661)	68" (1727)	23.15 (2.15)	11.58 (1.08)	11.57 (1.07)	12.30 (1.14)	12 1/2" (318)	29.54 (2.74)
5610	1.61 (0.15)	29 1/16" (738)	8" (203)	2.08 (0.19)	1.04 (0.10)	1.04 (0.10)	1.61 (0.15)	72 1/2" (1842)	5.23 (0.49)
5616	2.82 (0.26)	29 1/16" (738)	14" (356)	4.46 (0.41)	2.23 (0.21)	2.23 (0.21)	2.82 (0.26)	66 1/2" (1689)	7.96 (0.74)
5620	4.03 (0.37)	29 1/16" (738)	20" (508)	6.84 (0.64)	3.42 (0.32)	3.42 (0.32)	4.03 (0.37)	60 1/2" (1537)	10.69 (0.99)
5626	5.24 (0.49)	29 1/16" (738)	26" (660)	9.22 (0.86)	4.61 (0.43)	4.61 (0.43)	5.24 (0.49)	54 1/2" (1384)	13.42 (1.25)
5630 ◊	6.45 (0.60)	29 1/16" (738)	32" (813)	11.60 (1.08)	5.80 (0.54)	5.79 (0.54)	6.45 (0.60)	48 1/2" (1232)	16.15 (1.50)
5636 ◊	7.66 (0.71)	29 1/16" (738)	38" (965)	13.98 (1.30)	6.99 (0.65)	6.98 (0.65)	7.66 (0.71)	42 1/2" (1080)	18.88 (1.75)
5640 ◊	8.87 (0.82)	29 1/16" (738)	44" (1118)	16.35 (1.52)	8.18 (0.76)	8.17 (0.76)	8.87 (0.82)	36 1/2" (927)	21.61 (2.01)
5646 ◊	10.08 (0.94)	29 1/16" (738)	50" (1270)	18.73 (1.74)	9.37 (0.87)	9.36 (0.87)	10.08 (0.94)	30 1/2" (775)	24.34 (2.26)
5650 ◊	11.29 (1.05)	29 1/16" (738)	56" (1422)	21.11 (1.96)	10.56 (0.98)	10.55 (0.98)	11.29 (1.05)	24 1/2" (622)	27.06 (2.51)
5656 ◊	12.50 (1.16)	29 1/16" (738)	62" (1575)	23.49 (2.18)	11.75 (1.09)	11.74 (1.09)	12.50 (1.16)	18 1/2" (470)	29.79 (2.77)
5660 ◊	13.71 (1.27)	29 1/16" (738)	68" (1727)	25.87 (2.40)	12.94 (1.20)	12.92 (1.20)	13.71 (1.27)	12 1/2" (318)	32.52 (3.02)
6010	1.78 (0.17)	32 1/16" (814)	8" (203)	2.30 (0.21)	1.15 (0.11)	1.15 (0.11)	1.78 (0.17)	72 1/2" (1842)	5.71 (0.53)
6016	3.11 (0.29)	32 1/16" (814)	14" (356)	4.93 (0.46)	2.47 (0.23)	2.46 (0.23)	3.11 (0.29)	66 1/2" (1689)	8.69 (0.81)
6020	4.45 (0.41)	32 1/16" (814)	20" (508)	7.56 (0.70)	3.78 (0.35)	3.78 (0.35)	4.45 (0.41)	60 1/2" (1537)	11.67 (1.08)
6026 ◊	5.78 (0.54)	32 1/16" (814)	26" (660)	10.19 (0.95)	5.10 (0.47)	5.09 (0.47)	5.78 (0.54)	54 1/2" (1384)	14.65 (1.36)
6030 ◊	7.12 (0.66)	32 1/16" (814)	32" (813)	12.82 (1.19)	6.41 (0.60)	6.40 (0.59)	7.12 (0.66)	48 1/2" (1232)	17.63 (1.64)
6036 ◊	8.45 (0.79)	32 1/16" (814)	38" (965)	15.44 (1.43)	7.73 (0.72)	7.72 (0.72)	8.45 (0.79)	42 1/2" (1080)	20.61 (1.91)
6040 ◊	9.79 (0.91)	32 1/16" (814)	44" (1118)	18.07 (1.68)	9.04 (0.84)	9.03 (0.84)	9.79 (0.91)	36 1/2" (927)	23.59 (2.19)
6046 ◊	11.12 (1.03)	32 1/16" (814)	50" (1270)	20.70 (1.92)	10.36 (0.96)	10.34 (0.96)	11.12 (1.03)	30 1/2" (775)	26.56 (2.47)
6050 ◊	12.46 (1.16)	32 1/16" (814)	56" (1422)	23.33 (2.17)	11.67 (1.08)	11.66 (1.08)	12.46 (1.16)	24 1/2" (622)	29.54 (2.74)
6056 ◊	13.79 (1.28)	32 1/16" (814)	62" (1575)	25.96 (2.41)	12.99 (1.21)	12.97 (1.21)	13.79 (1.28)	18 1/2" (470)	32.52 (3.02)
6060 ◊	15.13 (1.41)	32 1/16" (814)	68" (1727)	28.59 (2.66)	14.30 (1.33)	14.28 (1.33)	15.13 (1.41)	12 1/2" (318)	35.50 (3.30)

*"Top of Subfloor to Top of Inside Sill Stop" is calculated based upon a structural header height of 6'-10 1/2" (2096).
 • Dimensions in parentheses are in millimeters or square meters.
 ◊ Meet or exceed clear opening area of 5.7 sq.ft. or 0.53 m², clear opening width of 20" (508) and clear opening height of 24" (610).

GLIDING WINDOWS

Gliding Window Opening and Area Specifications – Active-Stationary-Active (XOX) 1:2:1 Sash Ratio

Window Number	Clear Opening Area Sq. Ft./ (m ²)		Clear Opening in Full Open Position		Total Glass Area Sq. Ft./ (m ²)	Fixed Sash Glass Area Sq. Ft./ (m ²)	Single Active Sash Glass Area Sq. Ft./ (m ²)	Vent Area Sq. Ft./ (m ²)	Top of Subfloor to Top of Inside Sill Stop Inches/(mm)	Overall Window Area Sq. Ft./ (m ²)
			Width Inches/(mm)	Height Inches/(mm)						
5016	1.16	(0.11)	11 7/8" (302)	14" (356)	3.82 (0.36)	2.18 (0.20)	0.82 (0.08)	2.31 (0.21)	66 1/2" (1689)	7.23 (0.67)
5020	1.65	(0.15)	11 7/8" (302)	20" (508)	5.86 (0.54)	3.34 (0.31)	1.26 (0.12)	3.31 (0.31)	60 1/2" (1537)	9.71 (0.90)
5026	2.15	(0.20)	11 7/8" (302)	26" (660)	7.90 (0.73)	4.50 (0.42)	1.70 (0.16)	4.30 (0.40)	54 1/2" (1384)	12.19 (1.13)
5030	2.64	(0.25)	11 7/8" (302)	32" (813)	9.94 (0.92)	5.66 (0.53)	2.14 (0.20)	5.29 (0.49)	48 1/2" (1232)	14.67 (1.36)
5036	3.14	(0.29)	11 7/8" (302)	38" (965)	11.98 (1.11)	6.83 (0.63)	2.58 (0.24)	6.28 (0.58)	42 1/2" (1080)	17.15 (1.59)
5040	3.64	(0.34)	11 7/8" (302)	44" (1118)	14.02 (1.30)	7.99 (0.74)	3.01 (0.28)	7.27 (0.68)	36 1/2" (927)	19.63 (1.82)
5046	4.13	(0.38)	11 7/8" (302)	50" (1270)	16.06 (1.49)	9.15 (0.85)	3.45 (0.32)	8.26 (0.77)	30 1/2" (775)	22.11 (2.05)
5050	4.63	(0.43)	11 7/8" (302)	56" (1422)	18.09 (1.68)	10.31 (0.96)	3.89 (0.36)	9.25 (0.86)	24 1/2" (622)	24.59 (2.28)
5056	5.12	(0.48)	11 7/8" (302)	62" (1575)	20.13 (1.87)	11.47 (1.07)	4.33 (0.40)	10.25 (0.95)	18 1/2" (470)	27.06 (2.51)
5060	5.62	(0.52)	11 7/8" (302)	68" (1727)	22.17 (2.06)	12.63 (1.17)	4.77 (0.44)	11.24 (1.04)	12 1/2" (318)	29.54 (2.74)
6016	1.45	(0.13)	14 7/8" (378)	14" (356)	4.76 (0.44)	2.65 (0.25)	1.06 (0.10)	2.90 (0.27)	66 1/2" (1689)	8.69 (0.81)
6020	2.07	(0.19)	14 7/8" (378)	20" (508)	7.30 (0.68)	4.06 (0.38)	1.62 (0.15)	4.14 (0.38)	60 1/2" (1537)	11.67 (1.08)
6026	2.69	(0.25)	14 7/8" (378)	26" (660)	9.84 (0.91)	5.47 (0.51)	2.18 (0.20)	5.38 (0.50)	54 1/2" (1384)	14.65 (1.36)
6030	3.31	(0.31)	14 7/8" (378)	32" (813)	12.38 (1.15)	6.88 (0.64)	2.75 (0.26)	6.62 (0.62)	48 1/2" (1232)	17.63 (1.64)
6036	3.93	(0.37)	14 7/8" (378)	38" (965)	14.92 (1.39)	8.29 (0.77)	3.31 (0.31)	7.86 (0.73)	42 1/2" (1080)	20.61 (1.91)
6040	4.55	(0.42)	14 7/8" (378)	44" (1118)	17.45 (1.62)	9.71 (0.90)	3.87 (0.36)	9.10 (0.85)	36 1/2" (927)	23.59 (2.19)
6046	5.17	(0.48)	14 7/8" (378)	50" (1270)	19.99 (1.86)	11.12 (1.03)	4.44 (0.41)	10.35 (0.96)	30 1/2" (775)	26.56 (2.47)
6050	5.79	(0.54)	14 7/8" (378)	56" (1422)	22.53 (2.09)	12.53 (1.16)	5.00 (0.46)	11.59 (1.08)	24 1/2" (622)	29.54 (2.74)
6056	6.41	(0.60)	14 7/8" (378)	62" (1575)	25.07 (2.33)	13.94 (1.30)	5.56 (0.52)	12.83 (1.19)	18 1/2" (470)	32.52 (3.02)
6060	7.04	(0.65)	14 7/8" (378)	68" (1727)	27.61 (2.56)	15.35 (1.43)	6.13 (0.57)	14.07 (1.31)	12 1/2" (318)	35.50 (3.30)
7016	1.74	(0.16)	17 7/8" (455)	14" (356)	5.70 (0.53)	3.12 (0.29)	1.29 (0.12)	3.48 (0.32)	66 1/2" (1689)	10.15 (0.94)
7020	2.49	(0.23)	17 7/8" (455)	20" (508)	8.74 (0.81)	4.78 (0.44)	1.98 (0.18)	4.97 (0.46)	60 1/2" (1537)	13.63 (1.27)
7026	3.23	(0.30)	17 7/8" (455)	26" (660)	11.78 (1.09)	6.44 (0.60)	2.67 (0.25)	6.46 (0.60)	54 1/2" (1384)	17.11 (1.59)
7030	3.98	(0.37)	17 7/8" (455)	32" (813)	14.81 (1.38)	8.10 (0.75)	3.36 (0.31)	7.96 (0.74)	48 1/2" (1232)	20.59 (1.91)
7036	4.72	(0.44)	17 7/8" (455)	38" (965)	17.85 (1.66)	9.76 (0.91)	4.04 (0.38)	9.45 (0.88)	42 1/2" (1080)	24.06 (2.24)
7040	5.47	(0.51)	17 7/8" (455)	44" (1118)	20.89 (1.94)	11.42 (1.06)	4.73 (0.44)	10.94 (1.02)	36 1/2" (927)	27.54 (2.56)
7046	6.21	(0.58)	17 7/8" (455)	50" (1270)	23.93 (2.22)	13.09 (1.22)	5.42 (0.50)	12.43 (1.15)	30 1/2" (775)	31.02 (2.88)
7050	6.96	(0.65)	17 7/8" (455)	56" (1422)	26.97 (2.51)	14.75 (1.37)	6.11 (0.57)	13.92 (1.29)	24 1/2" (622)	34.50 (3.21)
7056	7.71	(0.72)	17 7/8" (455)	62" (1575)	30.01 (2.79)	16.41 (1.52)	6.80 (0.63)	15.41 (1.43)	18 1/2" (470)	37.98 (3.53)
7060	8.45	(0.79)	17 7/8" (455)	68" (1727)	33.05 (3.07)	18.07 (1.68)	7.49 (0.70)	16.90 (1.57)	12 1/2" (318)	41.46 (3.85)
7616	1.89	(0.18)	19 3/8" (493)	14" (356)	6.17 (0.57)	3.35 (0.31)	1.41 (0.13)	3.77 (0.35)	66 1/2" (1689)	10.88 (1.01)
7620	2.69	(0.25)	19 3/8" (493)	20" (508)	9.46 (0.88)	5.14 (0.48)	2.16 (0.20)	5.39 (0.50)	60 1/2" (1537)	14.61 (1.36)
7626	3.50	(0.33)	19 3/8" (493)	26" (660)	12.74 (1.18)	6.92 (0.64)	2.91 (0.27)	7.01 (0.65)	54 1/2" (1384)	18.34 (1.70)
7630	4.31	(0.40)	19 3/8" (493)	32" (813)	16.03 (1.49)	8.71 (0.81)	3.66 (0.34)	8.62 (0.80)	48 1/2" (1232)	22.06 (2.05)
7636	5.12	(0.48)	19 3/8" (493)	38" (965)	19.32 (1.80)	10.50 (0.98)	4.41 (0.41)	10.24 (0.95)	42 1/2" (1080)	25.79 (2.40)
7640	5.93	(0.55)	19 3/8" (493)	44" (1118)	22.61 (2.10)	12.28 (1.14)	5.16 (0.48)	11.85 (1.10)	36 1/2" (927)	29.52 (2.74)
7646	6.74	(0.63)	19 3/8" (493)	50" (1270)	25.90 (2.41)	14.07 (1.31)	5.91 (0.55)	13.47 (1.25)	30 1/2" (775)	33.25 (3.09)
7650	7.54	(0.70)	19 3/8" (493)	56" (1422)	29.19 (2.71)	15.86 (1.47)	6.67 (0.62)	15.09 (1.40)	24 1/2" (622)	36.98 (3.44)
7656	8.35	(0.78)	19 3/8" (493)	62" (1575)	32.48 (3.02)	17.64 (1.64)	7.42 (0.69)	16.70 (1.55)	18 1/2" (470)	40.71 (3.78)
7660	9.16	(0.85)	19 3/8" (493)	68" (1727)	35.77 (3.32)	19.43 (1.81)	8.17 (0.76)	18.32 (1.70)	12 1/2" (318)	44.44 (4.13)
8016	2.03	(0.19)	20 7/8" (531)	14" (356)	6.64 (0.62)	3.58 (0.33)	1.53 (0.14)	4.06 (0.38)	66 1/2" (1689)	11.61 (1.08)
8020	2.90	(0.27)	20 7/8" (531)	20" (508)	10.17 (0.95)	5.50 (0.51)	2.34 (0.22)	5.81 (0.54)	60 1/2" (1537)	15.59 (1.45)
8026	3.77	(0.35)	20 7/8" (531)	26" (660)	13.71 (1.27)	7.41 (0.69)	3.15 (0.29)	7.55 (0.70)	54 1/2" (1384)	19.56 (1.82)
8030	4.64	(0.43)	20 7/8" (531)	32" (813)	17.25 (1.60)	9.32 (0.87)	3.97 (0.37)	9.29 (0.86)	48 1/2" (1232)	23.54 (2.19)
8036	5.52	(0.51)	20 7/8" (531)	38" (965)	20.79 (1.93)	11.23 (1.04)	4.78 (0.44)	11.03 (1.02)	42 1/2" (1080)	27.52 (2.56)
8040 ◊	6.39	(0.59)	20 7/8" (531)	44" (1118)	24.33 (2.26)	13.14 (1.22)	5.59 (0.52)	12.77 (1.19)	36 1/2" (927)	31.50 (2.93)
8046 ◊	7.26	(0.67)	20 7/8" (531)	50" (1270)	27.87 (2.59)	15.06 (1.40)	6.41 (0.60)	14.51 (1.35)	30 1/2" (775)	35.48 (3.30)
8050 ◊	8.13	(0.76)	20 7/8" (531)	56" (1422)	31.41 (2.92)	16.97 (1.58)	7.22 (0.67)	16.25 (1.51)	24 1/2" (622)	39.46 (3.67)
8056 ◊	9.00	(0.84)	20 7/8" (531)	62" (1575)	34.95 (3.25)	18.88 (1.75)	8.03 (0.75)	18.00 (1.67)	18 1/2" (470)	43.44 (4.04)
8060 ◊	9.87	(0.92)	20 7/8" (531)	68" (1727)	38.48 (3.58)	20.79 (1.93)	8.85 (0.82)	19.74 (1.83)	12 1/2" (318)	47.42 (4.41)
8616	2.18	(0.20)	22 3/8" (569)	14" (356)	7.10 (0.66)	3.82 (0.35)	1.64 (0.15)	4.36 (0.40)	66 1/2" (1689)	12.34 (1.15)
8620	3.11	(0.29)	22 3/8" (569)	20" (508)	10.89 (1.01)	5.86 (0.54)	2.52 (0.23)	6.22 (0.58)	60 1/2" (1537)	16.56 (1.54)
8626	4.04	(0.38)	22 3/8" (569)	26" (660)	14.68 (1.36)	7.89 (0.73)	3.39 (0.32)	8.09 (0.75)	54 1/2" (1384)	20.79 (1.93)
8630	4.98	(0.46)	22 3/8" (569)	32" (813)	18.47 (1.72)	9.93 (0.92)	4.27 (0.40)	9.96 (0.92)	48 1/2" (1232)	25.02 (2.32)
8636 ◊	5.91	(0.55)	22 3/8" (569)	38" (965)	22.26 (2.07)	11.97 (1.11)	5.15 (0.48)	11.82 (1.10)	42 1/2" (1080)	29.25 (2.72)
8640 ◊	6.84	(0.64)	22 3/8" (569)	44" (1118)	26.05 (2.42)	14.00 (1.30)	6.02 (0.56)	13.69 (1.27)	36 1/2" (927)	33.48 (3.11)
8646 ◊	7.78	(0.72)	22 3/8" (569)	50" (1270)	29.84 (2.77)	16.04 (1.49)	6.90 (0.64)	15.55 (1.45)	30 1/2" (775)	37.71 (3.50)
8650 ◊	8.71	(0.81)	22 3/8" (569)	56" (1422)	33.63 (3.12)	18.08 (1.68)	7.77 (0.72)	17.42 (1.62)	24 1/2" (622)	41.94 (3.90)

*Top of Subfloor to Top of Inside Sill Stop" is calculated based upon a structural header height of 6'-10 1/2" (2096).

◊Dimensions in parentheses are in millimeters or square meters.

◊Meet or exceed clear opening area of 5.7 sq.ft. or 0.53 m², clear opening width of 20" (508) and clear opening height of 24" (610).

continued on next page

Gliding Window Opening and Area Specifications – Active-Stationary-Active (XOX) 1:2:1 Sash Ratio *(continued)*

Window Number	Clear Opening Area Sq. Ft./ (m ²)	Clear Opening in Full Open Position		Total Glass Area Sq. Ft./ (m ²)	Fixed Sash Glass Area Sq. Ft./ (m ²)	Single Active Sash Glass Area Sq. Ft./ (m ²)	Vent Area Sq. Ft./ (m ²)	Top of Subfloor to Top of Inside Sill Stop Inches/ (mm)	Overall Window Area Sq. Ft./ (m ²)
		Width Inches/ (mm)	Height Inches/ (mm)						
8656 ◊	9.64 (0.90)	22 3/8" (569)	62" (1575)	37.41 (3.48)	20.11 (1.87)	8.65 (0.80)	19.29 (1.79)	18 1/2" (470)	46.17 (4.29)
8660 ◊	10.58 (0.98)	22 3/8" (569)	68" (1727)	41.20 (3.83)	22.15 (2.06)	9.53 (0.89)	21.15 (1.97)	12 1/2" (318)	50.40 (4.68)
9016	2.32 (0.22)	23 7/8" (607)	14" (356)	7.57 (0.70)	4.05 (0.38)	1.76 (0.16)	4.65 (0.43)	66 1/2" (1689)	13.06 (1.21)
9020	3.32 (0.31)	23 7/8" (607)	20" (508)	11.61 (1.08)	6.22 (0.58)	2.70 (0.25)	6.64 (0.62)	60 1/2" (1537)	17.54 (1.63)
9026	4.32 (0.40)	23 7/8" (607)	26" (660)	15.65 (1.45)	8.38 (0.78)	3.64 (0.34)	8.63 (0.80)	54 1/2" (1384)	22.02 (2.05)
9030	5.31 (0.49)	23 7/8" (607)	32" (813)	19.69 (1.83)	10.54 (0.98)	4.58 (0.43)	10.62 (0.99)	48 1/2" (1232)	26.50 (2.46)
9036 ◊	6.31 (0.59)	23 7/8" (607)	38" (965)	23.73 (2.20)	12.70 (1.18)	5.51 (0.51)	12.61 (1.17)	42 1/2" (1080)	30.98 (2.88)
9040 ◊	7.30 (0.68)	23 7/8" (607)	44" (1118)	27.77 (2.58)	14.86 (1.38)	6.45 (0.60)	14.60 (1.36)	36 1/2" (927)	35.46 (3.29)
9046 ◊	8.30 (0.77)	23 7/8" (607)	50" (1270)	31.81 (2.95)	17.02 (1.58)	7.39 (0.69)	16.60 (1.54)	30 1/2" (775)	39.94 (3.71)
9050 ◊	9.29 (0.86)	23 7/8" (607)	56" (1422)	35.84 (3.33)	19.19 (1.78)	8.33 (0.77)	18.59 (1.73)	24 1/2" (622)	44.42 (4.13)
9056 ◊	10.29 (0.96)	23 7/8" (607)	62" (1575)	39.88 (3.71)	21.35 (1.98)	9.27 (0.86)	20.58 (1.91)	18 1/2" (470)	48.90 (4.54)
9060 ◊	11.29 (1.05)	23 7/8" (607)	68" (1727)	43.92 (4.08)	23.51 (2.18)	10.21 (0.95)	22.57 (2.10)	12 1/2" (318)	53.38 (4.96)
10016	2.62 (0.24)	26 7/8" (683)	14" (356)	8.51 (0.79)	4.52 (0.42)	1.99 (0.19)	5.23 (0.49)	66 1/2" (1689)	14.52 (1.35)
10020	3.74 (0.35)	26 7/8" (683)	20" (508)	13.05 (1.21)	6.93 (0.64)	3.06 (0.28)	7.47 (0.69)	60 1/2" (1537)	19.50 (1.81)
10026	4.86 (0.45)	26 7/8" (683)	26" (660)	17.59 (1.63)	9.35 (0.87)	4.12 (0.38)	9.71 (0.90)	54 1/2" (1384)	24.48 (2.27)
10030	5.98 (0.56)	26 7/8" (683)	32" (813)	22.13 (2.06)	11.76 (1.09)	5.18 (0.48)	11.96 (1.11)	48 1/2" (1232)	29.46 (2.74)
10036 ◊	7.10 (0.66)	26 7/8" (683)	38" (965)	26.67 (2.48)	14.17 (1.32)	6.25 (0.58)	14.20 (1.32)	42 1/2" (1080)	34.44 (3.20)
10040 ◊	8.22 (0.76)	26 7/8" (683)	44" (1118)	31.20 (2.90)	16.58 (1.54)	7.31 (0.68)	16.44 (1.53)	36 1/2" (927)	39.42 (3.66)
10046 ◊	9.34 (0.87)	26 7/8" (683)	50" (1270)	35.74 (3.32)	18.99 (1.76)	8.38 (0.78)	18.68 (1.74)	30 1/2" (775)	44.40 (4.12)
10050 ◊	10.46 (0.97)	26 7/8" (683)	56" (1422)	40.28 (3.74)	21.40 (1.99)	9.44 (0.88)	20.92 (1.94)	24 1/2" (622)	49.38 (4.59)
10056 ◊	11.58 (1.08)	26 7/8" (683)	62" (1575)	44.82 (4.16)	23.82 (2.21)	10.50 (0.98)	23.16 (2.15)	18 1/2" (470)	54.36 (5.05)
10060 ◊	12.70 (1.18)	26 7/8" (683)	68" (1727)	49.36 (4.59)	26.23 (2.44)	11.57 (1.07)	25.40 (2.36)	12 1/2" (318)	59.34 (5.51)
11016	2.91 (0.27)	29 7/8" (759)	14" (356)	9.45 (0.88)	4.99 (0.46)	2.23 (0.21)	5.81 (0.54)	66 1/2" (1689)	15.98 (1.48)
11020	4.15 (0.39)	29 7/8" (759)	20" (508)	14.49 (1.35)	7.65 (0.71)	3.42 (0.32)	8.31 (0.77)	60 1/2" (1537)	21.46 (1.99)
11026	5.40 (0.50)	29 7/8" (759)	26" (660)	19.53 (1.81)	10.31 (0.96)	4.61 (0.43)	10.80 (1.00)	54 1/2" (1384)	26.94 (2.50)
11030 ◊	6.64 (0.62)	29 7/8" (759)	32" (813)	24.56 (2.28)	12.98 (1.21)	5.79 (0.54)	13.29 (1.23)	48 1/2" (1232)	32.42 (3.01)
11036 ◊	7.89 (0.73)	29 7/8" (759)	38" (965)	29.60 (2.75)	15.64 (1.45)	6.98 (0.65)	15.78 (1.47)	42 1/2" (1080)	37.90 (3.52)
11040 ◊	9.14 (0.85)	29 7/8" (759)	44" (1118)	34.64 (3.22)	18.30 (1.70)	8.17 (0.76)	18.27 (1.70)	36 1/2" (927)	43.38 (4.03)
11046 ◊	10.38 (0.96)	29 7/8" (759)	50" (1270)	39.68 (3.69)	20.96 (1.95)	9.36 (0.87)	20.76 (1.93)	30 1/2" (775)	48.86 (4.54)
11050 ◊	11.63 (1.08)	29 7/8" (759)	56" (1422)	44.72 (4.15)	23.62 (2.19)	10.55 (0.98)	23.25 (2.16)	24 1/2" (622)	54.34 (5.05)
11056 ◊	12.87 (1.20)	29 7/8" (759)	62" (1575)	49.76 (4.62)	26.28 (2.44)	11.74 (1.09)	25.75 (2.39)	18 1/2" (470)	59.81 (5.56)
11060 ◊	14.12 (1.31)	29 7/8" (759)	68" (1727)	54.80 (5.09)	28.95 (2.69)	12.92 (1.20)	28.24 (2.62)	12 1/2" (318)	65.29 (6.07)
12016	3.20 (0.30)	32 7/8" (836)	14" (356)	10.39 (0.96)	5.46 (0.51)	2.46 (0.23)	6.40 (0.59)	66 1/2" (1689)	17.44 (1.62)
12020	4.57 (0.42)	32 7/8" (836)	20" (508)	15.92 (1.48)	8.37 (0.78)	3.78 (0.35)	9.14 (0.85)	60 1/2" (1537)	23.42 (2.18)
12026 ◊	5.94 (0.55)	32 7/8" (836)	26" (660)	21.46 (1.99)	11.28 (1.05)	5.09 (0.47)	11.88 (1.10)	54 1/2" (1384)	29.40 (2.73)
12030 ◊	7.31 (0.68)	32 7/8" (836)	32" (813)	27.00 (2.51)	14.19 (1.32)	6.40 (0.59)	14.62 (1.36)	48 1/2" (1232)	35.38 (3.29)
12036 ◊	8.68 (0.81)	32 7/8" (836)	38" (965)	32.54 (3.02)	17.11 (1.59)	7.72 (0.72)	17.36 (1.61)	42 1/2" (1080)	41.36 (3.84)
12040 ◊	10.05 (0.93)	32 7/8" (836)	44" (1118)	38.08 (3.54)	20.02 (1.86)	9.03 (0.84)	20.10 (1.87)	36 1/2" (927)	47.34 (4.40)
12046 ◊	11.42 (1.06)	32 7/8" (836)	50" (1270)	43.62 (4.05)	22.93 (2.13)	10.34 (0.96)	22.85 (2.12)	30 1/2" (775)	53.31 (4.95)
12050 ◊	12.79 (1.19)	32 7/8" (836)	56" (1422)	49.16 (4.57)	25.84 (2.40)	11.66 (1.08)	25.59 (2.38)	24 1/2" (622)	59.29 (5.51)
12056 ◊	14.16 (1.32)	32 7/8" (836)	62" (1575)	54.70 (5.08)	28.75 (2.67)	12.97 (1.21)	28.33 (2.63)	18 1/2" (470)	65.27 (6.06)
12060 ◊	15.54 (1.44)	32 7/8" (836)	68" (1727)	60.23 (5.60)	31.67 (2.94)	14.28 (1.33)	31.07 (2.89)	12 1/2" (318)	71.25 (6.62)

• "Top of Subfloor to Top of Inside Sill Stop" is calculated based upon a structural header height of 6'-10 1/2" (2096).
 • Dimensions in parentheses are in millimeters or square meters.
 ◊ Meet or exceed clear opening area of 5.7 sq.ft. or 0.53 m², clear opening width of 20" (508) and clear opening height of 24"(610).

100 Series
Gliding Windows

GLIDING WINDOWS

Gliding Window Opening and Area Specifications – Active-Stationary-Active (XOX) 1:1:1 Equal Sash Ratio

Window Number	Clear Opening Area Sq. Ft./ (m ²)	Clear Opening in Full Open Position		Total Glass Area Sq. Ft./ (m ²)	Fixed Sash Glass Area Sq. Ft./ (m ²)	Single Active Sash Glass Area Sq. Ft./ (m ²)	Vent Area Sq. Ft./ (m ²)	Top of Subfloor to Top of Inside Sill Stop Inches/(mm)	Overall Window Area Sq. Ft./ (m ²)
		Width Inches/(mm)	Height Inches/(mm)						
4016	1.04 (0.10)	10 5/8" (271)	14" (356)	2.89 (0.27)	0.96 (0.09)	0.96 (0.09)	2.07 (0.19)	66 1/2" (1689)	5.77 (0.54)
4020	1.48 (0.14)	10 5/8" (271)	20" (508)	4.42 (0.41)	1.48 (0.14)	1.47 (0.14)	2.96 (0.28)	60 1/2" (1537)	7.75 (0.72)
4026	1.93 (0.18)	10 5/8" (271)	26" (660)	5.96 (0.55)	1.99 (0.19)	1.99 (0.18)	3.85 (0.36)	54 1/2" (1384)	9.73 (0.90)
4030	2.37 (0.22)	10 5/8" (271)	32" (813)	7.50 (0.70)	2.51 (0.23)	2.50 (0.23)	4.74 (0.44)	48 1/2" (1232)	11.71 (1.09)
4036	2.82 (0.26)	10 5/8" (271)	38" (965)	9.04 (0.84)	3.02 (0.28)	3.01 (0.28)	5.63 (0.52)	42 1/2" (1080)	13.69 (1.27)
4040	3.26 (0.30)	10 5/8" (271)	44" (1118)	10.58 (0.98)	3.53 (0.33)	3.52 (0.33)	6.52 (0.61)	36 1/2" (927)	15.67 (1.46)
4046	3.70 (0.34)	10 5/8" (271)	50" (1270)	12.12 (1.13)	4.05 (0.38)	4.03 (0.37)	7.41 (0.69)	30 1/2" (775)	17.65 (1.64)
4050	4.15 (0.39)	10 5/8" (271)	56" (1422)	13.66 (1.27)	4.56 (0.42)	4.55 (0.42)	8.30 (0.77)	24 1/2" (622)	19.63 (1.82)
4056	4.59 (0.43)	10 5/8" (271)	62" (1575)	15.20 (1.41)	5.08 (0.47)	5.06 (0.47)	9.19 (0.85)	18 1/2" (470)	21.61 (2.01)
4060	5.04 (0.47)	10 5/8" (271)	68" (1727)	16.73 (1.55)	5.59 (0.52)	5.57 (0.52)	10.08 (0.94)	12 1/2" (318)	23.59 (2.19)
5016	1.43 (0.13)	14 5/8" (373)	14" (356)	3.82 (0.36)	1.28 (0.12)	1.27 (0.12)	2.85 (0.26)	66 1/2" (1689)	7.23 (0.67)
5020	2.04 (0.19)	14 5/8" (373)	20" (508)	5.86 (0.54)	1.96 (0.18)	1.95 (0.18)	4.07 (0.38)	60 1/2" (1537)	9.71 (0.90)
5026	2.65 (0.25)	14 5/8" (373)	26" (660)	7.90 (0.73)	2.64 (0.25)	2.63 (0.24)	5.30 (0.49)	54 1/2" (1384)	12.19 (1.13)
5030	3.26 (0.30)	14 5/8" (373)	32" (813)	9.94 (0.92)	3.32 (0.31)	3.31 (0.31)	6.52 (0.61)	48 1/2" (1232)	14.67 (1.36)
5036	3.87 (0.36)	14 5/8" (373)	38" (965)	11.98 (1.11)	4.00 (0.37)	3.99 (0.37)	7.74 (0.72)	42 1/2" (1080)	17.15 (1.59)
5040	4.48 (0.42)	14 5/8" (373)	44" (1118)	14.02 (1.30)	4.68 (0.43)	4.67 (0.43)	8.96 (0.83)	36 1/2" (927)	19.63 (1.82)
5046	5.09 (0.47)	14 5/8" (373)	50" (1270)	16.06 (1.49)	5.36 (0.50)	5.35 (0.50)	10.19 (0.95)	30 1/2" (775)	22.11 (2.05)
5050	5.70 (0.53)	14 5/8" (373)	56" (1422)	18.09 (1.68)	6.04 (0.56)	6.03 (0.56)	11.41 (1.06)	24 1/2" (622)	24.59 (2.28)
5056	6.32 (0.59)	14 5/8" (373)	62" (1575)	20.13 (1.87)	6.72 (0.62)	6.71 (0.62)	12.63 (1.17)	18 1/2" (470)	27.06 (2.51)
5060	6.93 (0.64)	14 5/8" (373)	68" (1727)	22.17 (2.06)	7.40 (0.69)	7.38 (0.69)	13.85 (1.29)	12 1/2" (318)	29.54 (2.74)
6016	1.82 (0.17)	18 5/8" (474)	14" (356)	4.76 (0.44)	1.59 (0.15)	1.59 (0.15)	3.63 (0.34)	66 1/2" (1689)	8.69 (0.81)
6020	2.59 (0.24)	18 5/8" (474)	20" (508)	7.30 (0.68)	2.44 (0.23)	2.43 (0.23)	5.19 (0.48)	60 1/2" (1537)	11.67 (1.08)
6026	3.37 (0.31)	18 5/8" (474)	26" (660)	9.84 (0.91)	3.28 (0.31)	3.28 (0.30)	6.74 (0.63)	54 1/2" (1384)	14.65 (1.36)
6030	4.15 (0.39)	18 5/8" (474)	32" (813)	12.38 (1.15)	4.13 (0.38)	4.12 (0.38)	8.30 (0.77)	48 1/2" (1232)	17.63 (1.64)
6036	4.93 (0.46)	18 5/8" (474)	38" (965)	14.92 (1.39)	4.98 (0.46)	4.97 (0.46)	9.85 (0.92)	42 1/2" (1080)	20.61 (1.91)
6040	5.70 (0.53)	18 5/8" (474)	44" (1118)	17.45 (1.62)	5.83 (0.54)	5.81 (0.54)	11.41 (1.06)	36 1/2" (927)	23.59 (2.19)
6046	6.48 (0.60)	18 5/8" (474)	50" (1270)	19.99 (1.86)	6.67 (0.62)	6.66 (0.62)	12.96 (1.20)	30 1/2" (775)	26.56 (2.47)
6050	7.26 (0.67)	18 5/8" (474)	56" (1422)	22.53 (2.09)	7.52 (0.70)	7.51 (0.70)	14.52 (1.35)	24 1/2" (622)	29.54 (2.74)
6056	8.04 (0.75)	18 5/8" (474)	62" (1575)	25.07 (2.33)	8.37 (0.78)	8.35 (0.78)	16.08 (1.49)	18 1/2" (470)	32.52 (3.02)
6060	8.82 (0.82)	18 5/8" (474)	68" (1727)	27.61 (2.56)	9.22 (0.86)	9.20 (0.85)	17.63 (1.64)	12 1/2" (318)	35.50 (3.30)
7016	2.20 (0.20)	22 5/8" (576)	14" (356)	5.70 (0.53)	1.90 (0.18)	1.90 (0.18)	4.41 (0.41)	66 1/2" (1689)	10.15 (0.94)
7020	3.15 (0.29)	22 5/8" (576)	20" (508)	8.74 (0.81)	2.92 (0.27)	2.91 (0.27)	6.30 (0.59)	60 1/2" (1537)	13.63 (1.27)
7026	4.09 (0.38)	22 5/8" (576)	26" (660)	11.78 (1.09)	3.93 (0.37)	3.92 (0.36)	8.19 (0.76)	54 1/2" (1384)	17.11 (1.59)
7030	5.04 (0.47)	22 5/8" (576)	32" (813)	14.81 (1.38)	4.94 (0.46)	4.94 (0.46)	10.08 (0.94)	48 1/2" (1232)	20.59 (1.91)
7036 ◊	5.98 (0.56)	22 5/8" (576)	38" (965)	17.85 (1.66)	5.96 (0.55)	5.95 (0.55)	11.96 (1.11)	42 1/2" (1080)	24.06 (2.24)
7040 ◊	6.93 (0.64)	22 5/8" (576)	44" (1118)	20.89 (1.94)	6.97 (0.65)	6.96 (0.65)	13.85 (1.29)	36 1/2" (927)	27.54 (2.56)
7046 ◊	7.87 (0.73)	22 5/8" (576)	50" (1270)	23.93 (2.22)	7.99 (0.74)	7.97 (0.74)	15.74 (1.46)	30 1/2" (775)	31.02 (2.88)
7050 ◊	8.82 (0.82)	22 5/8" (576)	56" (1422)	26.97 (2.51)	9.00 (0.84)	8.98 (0.83)	17.63 (1.64)	24 1/2" (622)	34.50 (3.21)
7056 ◊	9.76 (0.91)	22 5/8" (576)	62" (1575)	30.01 (2.79)	10.01 (0.93)	10.00 (0.93)	19.52 (1.81)	18 1/2" (470)	37.98 (3.53)
7060 ◊	10.70 (0.99)	22 5/8" (576)	68" (1727)	33.05 (3.07)	11.03 (1.02)	11.01 (1.02)	21.41 (1.99)	12 1/2" (318)	41.46 (3.85)
7616	2.40 (0.22)	24 5/8" (627)	14" (356)	6.17 (0.57)	2.06 (0.19)	2.05 (0.19)	4.80 (0.45)	66 1/2" (1689)	10.88 (1.01)
7620	3.43 (0.32)	24 5/8" (627)	20" (508)	9.46 (0.88)	3.15 (0.29)	3.15 (0.29)	6.85 (0.64)	60 1/2" (1537)	14.61 (1.36)
7626	4.45 (0.41)	24 5/8" (627)	26" (660)	12.74 (1.18)	4.25 (0.40)	4.25 (0.39)	8.91 (0.83)	54 1/2" (1384)	18.34 (1.70)
7630	5.48 (0.51)	24 5/8" (627)	32" (813)	16.03 (1.49)	5.35 (0.50)	5.34 (0.50)	10.96 (1.02)	48 1/2" (1232)	22.06 (2.05)
7636 ◊	6.51 (0.60)	24 5/8" (627)	38" (965)	19.32 (1.80)	6.45 (0.60)	6.44 (0.60)	13.02 (1.21)	42 1/2" (1080)	25.79 (2.40)
7640 ◊	7.54 (0.70)	24 5/8" (627)	44" (1118)	22.61 (2.10)	7.54 (0.70)	7.53 (0.70)	15.08 (1.40)	36 1/2" (927)	29.52 (2.74)
7646 ◊	8.57 (0.80)	24 5/8" (627)	50" (1270)	25.90 (2.41)	8.64 (0.80)	8.63 (0.80)	17.13 (1.59)	30 1/2" (775)	33.25 (3.09)
7650 ◊	9.59 (0.89)	24 5/8" (627)	56" (1422)	29.19 (2.71)	9.74 (0.90)	9.72 (0.90)	19.19 (1.78)	24 1/2" (622)	36.98 (3.44)
7656 ◊	10.62 (0.99)	24 5/8" (627)	62" (1575)	32.48 (3.02)	10.84 (1.01)	10.82 (1.01)	21.24 (1.97)	18 1/2" (470)	40.71 (3.78)
7660 ◊	11.65 (1.08)	24 5/8" (627)	68" (1727)	35.77 (3.32)	11.93 (1.11)	11.92 (1.11)	23.30 (2.16)	12 1/2" (318)	44.44 (4.13)
8016	2.59 (0.24)	26 5/8" (677)	14" (356)	6.64 (0.62)	2.21 (0.21)	2.21 (0.21)	5.19 (0.48)	66 1/2" (1689)	11.61 (1.08)
8020	3.70 (0.34)	26 5/8" (677)	20" (508)	10.17 (0.95)	3.39 (0.32)	3.39 (0.31)	7.41 (0.69)	60 1/2" (1537)	15.59 (1.45)
8026	4.82 (0.45)	26 5/8" (677)	26" (660)	13.71 (1.27)	4.58 (0.43)	4.57 (0.42)	9.63 (0.89)	54 1/2" (1384)	19.56 (1.82)
8030 ◊	5.93 (0.55)	26 5/8" (677)	32" (813)	17.25 (1.60)	5.76 (0.53)	5.75 (0.53)	11.85 (1.10)	48 1/2" (1232)	23.54 (2.19)
8036 ◊	7.04 (0.65)	26 5/8" (677)	38" (965)	20.79 (1.93)	6.94 (0.64)	6.93 (0.64)	14.08 (1.31)	42 1/2" (1080)	27.52 (2.56)
8040 ◊	8.15 (0.76)	26 5/8" (677)	44" (1118)	24.33 (2.26)	8.12 (0.75)	8.11 (0.75)	16.30 (1.51)	36 1/2" (927)	31.50 (2.93)
8046 ◊	9.26 (0.86)	26 5/8" (677)	50" (1270)	27.87 (2.59)	9.30 (0.86)	9.28 (0.86)	18.52 (1.72)	30 1/2" (775)	35.48 (3.30)
8050 ◊	10.37 (0.96)	26 5/8" (677)	56" (1422)	31.41 (2.92)	10.48 (0.97)	10.46 (0.97)	20.74 (1.93)	24 1/2" (622)	39.46 (3.67)

*Top of Subfloor to Top of Inside Sill Stop" is calculated based upon a structural header height of 6'-10 1/2" (2096).

continued on next page

◊Dimensions in parentheses are in millimeters or square meters.





◊Meet or exceed clear opening area of 5.7 sq.ft. or 0.53 m², clear opening width of 20" (508) and clear opening height of 24"(610).

Gliding Window Opening and Area Specifications – Active-Stationary-Active (XOX) 1:1:1 Equal Sash Ratio *(continued)*

Window Number	Clear Opening Area Sq. Ft./ (m ²)	Clear Opening in Full Open Position		Total Glass Area Sq. Ft./ (m ²)	Fixed Sash Glass Area Sq. Ft./ (m ²)	Single Active Sash Glass Area Sq. Ft./ (m ²)	Vent Area Sq. Ft./ (m ²)	Top of Subfloor to Top of Inside Sill Stop Inches/(mm)	Overall Window Area Sq. Ft./ (m ²)
		Width Inches/(mm)	Height Inches/(mm)						
8056 ◊	11.48 (1.07)	26 5/8" (677)	62" (1575)	34.95 (3.25)	11.66 (1.08)	11.64 (1.08)	22.97 (2.13)	18 1/2" (470)	43.44 (4.04)
8060 ◊	12.59 (1.17)	26 5/8" (677)	68" (1727)	38.48 (3.58)	12.84 (1.19)	12.82 (1.19)	25.19 (2.34)	12 1/2" (318)	47.42 (4.41)
8616	2.79 (0.26)	28 5/8" (728)	14" (356)	7.10 (0.66)	2.37 (0.22)	2.37 (0.22)	5.57 (0.52)	66 1/2" (1689)	12.34 (1.15)
8620	3.98 (0.37)	28 5/8" (728)	20" (508)	10.89 (1.01)	3.63 (0.34)	3.63 (0.34)	7.96 (0.74)	60 1/2" (1537)	16.56 (1.54)
8626	5.18 (0.48)	28 5/8" (728)	26" (660)	14.68 (1.36)	4.90 (0.46)	4.89 (0.45)	10.35 (0.96)	54 1/2" (1384)	20.79 (1.93)
8630 ◊	6.37 (0.59)	28 5/8" (728)	32" (813)	18.47 (1.72)	6.16 (0.57)	6.15 (0.57)	12.74 (1.18)	48 1/2" (1232)	25.02 (2.32)
8636 ◊	7.57 (0.70)	28 5/8" (728)	38" (965)	22.26 (2.07)	7.43 (0.69)	7.42 (0.69)	15.13 (1.41)	42 1/2" (1080)	29.25 (2.72)
8640 ◊	8.76 (0.81)	28 5/8" (728)	44" (1118)	26.05 (2.42)	8.69 (0.81)	8.68 (0.81)	17.52 (1.63)	36 1/2" (927)	33.48 (3.11)
8646 ◊	9.95 (0.92)	28 5/8" (728)	50" (1270)	29.84 (2.77)	9.95 (0.92)	9.94 (0.92)	19.91 (1.85)	30 1/2" (775)	37.71 (3.50)
8650 ◊	11.15 (1.04)	28 5/8" (728)	56" (1422)	33.63 (3.12)	11.22 (1.04)	11.20 (1.04)	22.30 (2.07)	24 1/2" (622)	41.94 (3.90)
8656 ◊	12.34 (1.15)	28 5/8" (728)	62" (1575)	37.41 (3.48)	12.48 (1.16)	12.47 (1.16)	24.69 (2.29)	18 1/2" (470)	46.17 (4.29)
8660 ◊	13.54 (1.26)	28 5/8" (728)	68" (1727)	41.20 (3.83)	13.75 (1.28)	13.73 (1.28)	27.08 (2.52)	12 1/2" (318)	50.40 (4.68)

• "Top of Subfloor to Top of Inside Sill Stop" is calculated based upon a structural header height of 6'-10 1/2" (2096).
 • Dimensions in parentheses are in millimeters or square meters.
 ◊ Meet or exceed clear opening area of 5.7 sq.ft. or 0.53 m²; clear opening width of 20" (508) and clear opening height of 24" (610).

Grille Patterns

	Prairie A	Colonial	Modified Colonial	Tall Fractional	Short Fractional
Gliding					

Number of lights and overall pattern varies with window size. Patterns shown may not be available for all sizes. Specified equal light pattern is also available. For more information on divided light, see page 13 or visit andersenwindows.com/grilles.

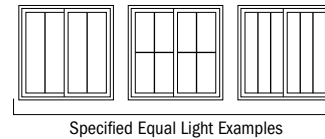

Gliding Window Details - New Construction

Scale 1 1/2" (38) = 1'-0" (305) - 1:8

1 3/8" flange setback

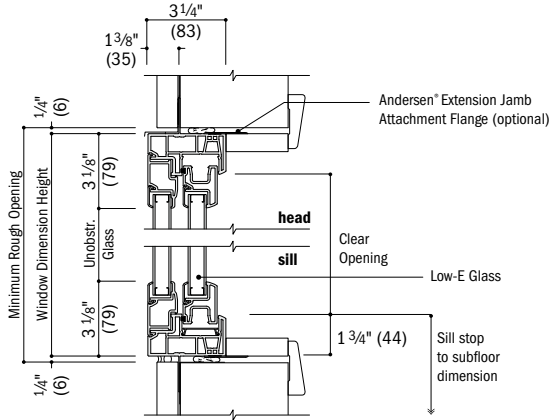

Vertical Section

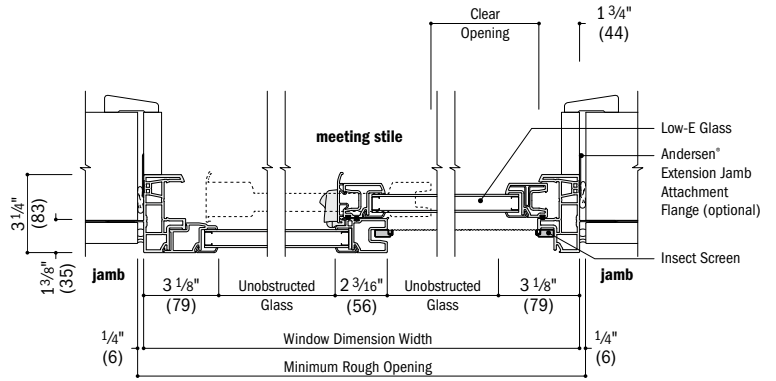

Horizontal Section

1" flange setback with stucco key

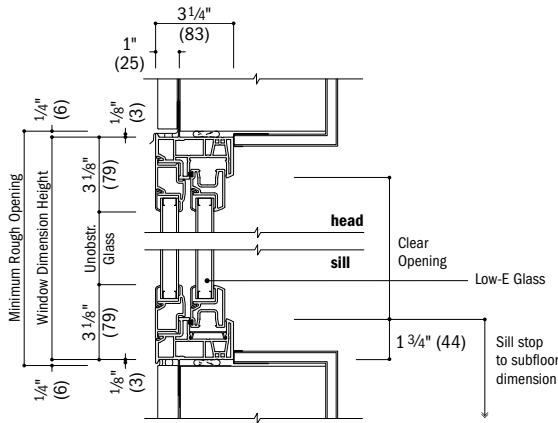

Vertical Section
stucco exterior

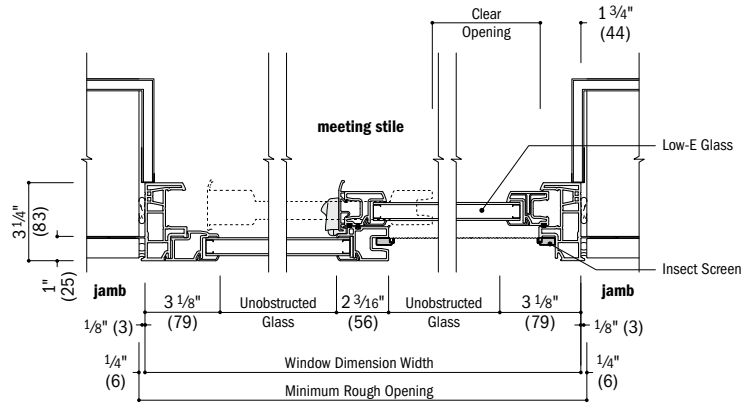

Horizontal Section
stucco exterior

integral

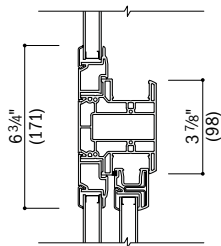

Vertical Section
Picture over Gliding

See pages 84-87 for horizontal and vertical joining details.

- Drip cap is required to complete window installation as shown, but may not be included with the window. Use of drip cap is recommended for proper installation.
- Light-colored areas are parts included with window. Dark-colored areas are additional Andersen® parts required to complete window assembly as shown.
- **Rough openings may need to be increased to allow for use of building wraps, flashing, sill panning, brackets, fasteners or other items. See installation information on page 109.**
- Details are for illustration only and are not intended to represent product installation methods or materials. Refer to product installation guides at andersenwindows.com.
- Dimensions in parentheses are in millimeters.

Gliding Window Details - Replacement

Scale 1 1/2" (38) = 1'-0" (305) - 1:8

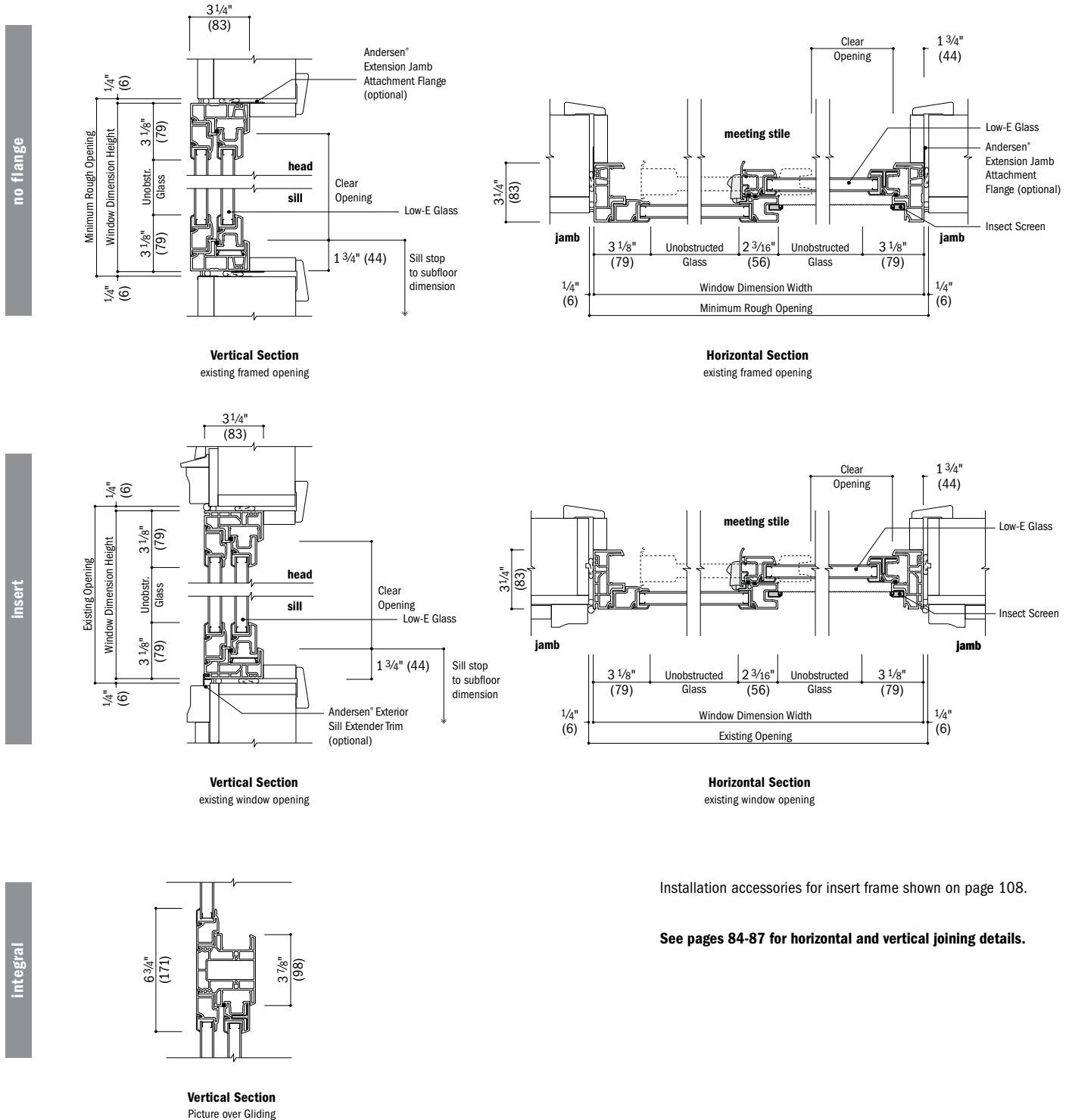

100 Series
Gliding Windows

Installation accessories for insert frame shown on page 108.

See pages 84-87 for horizontal and vertical joining details.

- Drip cap is required to complete window installation as shown, but may not be included with the window. Use of drip cap is recommended for proper installation.
- Light-colored areas are parts included with window. Dark-colored areas are additional Andersen® parts required to complete window assembly as shown.
- **Rough openings may need to be increased to allow for use of building wraps, flashing, sill panning, brackets, fasteners or other items. See installation information on page 109.**
- Details are for illustration only and are not intended to represent product installation methods or materials. Refer to product installation guides at andersenwindows.com.
- Dimensions in parentheses are in millimeters.

PICTURE, TRANSOM & SPECIALTY WINDOWS

Table of Picture and Single Transom Window Sizes

Scale 1/8" (3) = 1'-0" (305) - 1:96

Window Dimension	11 1/2" (292)	1'-5 1/2" (445)	1'-11 1/2" (597)	2'-5 1/2" (749)	2'-11 1/2" (902)	3'-5 1/2" (1054)	3'-11 1/2" (1207)	4'-5 1/2" (1359)	4'-11 1/2" (1511)	5'-5 1/2" (1664)
Minimum Rough Opening	1'-0" (305)	1'-6" (457)	2'-0" (610)	2'-6" (762)	3'-0" (914)	3'-6" (1067)	4'-0" (1219)	4'-6" (1372)	5'-0" (1524)	5'-6" (1676)
Unobstructed Glass	5 1/4" (133)	11 1/4" (286)	17 1/4" (438)	23 1/4" (591)	29 1/4" (743)	35 1/4" (895)	41 1/4" (1048)	47 1/4" (1200)	53 1/4" (1353)	59 1/4" (1505)

CUSTOM WIDTHS - 11 1/2" to 95 1/2"

11 1/2" (292)	1'-5 1/2" (445)	1'-11 1/2" (597)	2'-5 1/2" (749)	2'-11 1/2" (902)	3'-5 1/2" (1054)	3'-11 1/2" (1207)	4'-5 1/2" (1359)	4'-11 1/2" (1511)	5'-5 1/2" (1664)
1'-0" (305)	1'-6" (457)	2'-0" (610)	2'-6" (762)	3'-0" (914)	3'-6" (1067)	4'-0" (1219)	4'-6" (1372)	5'-0" (1524)	5'-6" (1676)
5 1/4" (133)	11 1/4" (286)	17 1/4" (438)	23 1/4" (591)	29 1/4" (743)	35 1/4" (895)	41 1/4" (1048)	47 1/4" (1200)	53 1/4" (1353)	59 1/4" (1505)
CUSTOM HEIGHTS - 11 1/2" TO 95 1/2"									
1010	1610	2010	2610	3010	3610	4010	4610	5010	5610
1016	1616	2016	2616	3016	3616	4016	4616	5016	5616
1020	1620	2020	2620	3020	3620	4020	4620	5020	5620
1026	1626	2026	2626	3026	3626	4026	4626	5026	5626
1030	1630	2030	2630	3030	3630	4030	4630	5030	5630
1036	1636	2036	2636	3036	3636	4036	4636	5036	5636
1040	1640	2040	2640	3040	3640	4040	4640	5040	5640
1046	1646	2046	2646	3046	3646	4046	4646	5046	5646
1050	1650	2050	2650	3050	3650	4050	4650	5050	5650
1056	1656	2056	2656	3056	3656	4056	4656	5056	5656
1060	1660	2060	2660	3060	3660	4060	4660	5060	5660
1066	1666	2066	2666	3066	3666	4066	4666	5066	5666

* "Window Dimension" always refers to outside frame to frame dimension.
 • "Minimum Rough Opening" dimensions may need to be increased to allow for use of building wraps, flashing, sill panning, brackets, fasteners or other items. See page 109 for more details.
 • Dimensions in parentheses are in millimeters.

Notes on this page also apply to the previous page. Picture and Single Transom sizes on pages 66-71.

5'-11 1/2" (1816)	6'-5 1/2" (1969)	6'-11 1/2" (2121)	7'-5 1/2" (2273)	7'-11 1/2" (2426)
6'-0" (1829)	6'-6" (1981)	7'-0" (2134)	7'-6" (2286)	8'-0" (2438)
65 1/4" (1657)	71 1/4" (1810)	77 1/4" (1962)	83 1/4" (2115)	89 1/4" (2267)



Custom-size windows are available in 1/8" (3) increments. See page 90 for custom sizes and specifications.

Details shown on pages 81-83.

Grille patterns shown on page 77.

6010	6610	7010	7610	8010
6016	6616	7016	7616	8016
6020	6620	7020	7620	8020
6026	6626	7026	7626	8026
6030	6630	7030	7630	8030
6036	6636	7036	7636	8036
6040	6640	7040	7640	8040
6046	6646	7046	7646	8046
6050	6650	7050	7650	8050
6056	6656	7056	7656	8056
6060	6660	7060	7660	8060
6066				

continued on next page

- "Window Dimension" always refers to outside frame to frame dimension.
- "Minimum Rough Opening" dimensions may need to be increased to allow for use of building wraps, flashing, sill panning, brackets, fasteners or other items. See page 109 for more details.
- Dimensions in parentheses are in millimeters.

PICTURE, TRANSOM & SPECIALTY WINDOWS

Table of Picture and Single Transom Window Sizes (continued)

Notes on the next page also apply to this page. Picture and Single Transom sizes on pages 66-71.

Scale 1/8" (3) = 1'-0" (305) – 1:96

Window Dimension	11 1/2" (292)	1'-5 1/2" (445)	1'-11 1/2" (597)	2'-5 1/2" (749)	2'-11 1/2" (902)	3'-5 1/2" (1054)	3'-11 1/2" (1207)	4'-5 1/2" (1359)	4'-11 1/2" (1511)	5'-5 1/2" (1664)
Minimum Rough Opening	1'-0" (305)	1'-6" (457)	2'-0" (610)	2'-6" (762)	3'-0" (914)	3'-6" (1067)	4'-0" (1219)	4'-6" (1372)	5'-0" (1524)	5'-6" (1676)
Unobstructed Glass	5 1/4" (133)	11 1/4" (286)	17 1/4" (438)	23 1/4" (591)	29 1/4" (743)	35 1/4" (895)	41 1/4" (1048)	47 1/4" (1200)	53 1/4" (1353)	59 1/4" (1505)

CUSTOM WIDTHS – 11 1/2" to 95 1/2"

6'-11 1/2" (2121) 7'-0" (2134) 77 1/4" (1962)	1070	1670	2070	2670	3070	3670	4070	4670	5070	5670
	1076	1676	2076	2676	3076	3676	4076	4676	5076	5676
	1080	1680	2080	2680	3080	3680	4080	4680	5080	5680
7'-5 1/2" (2273) 7'-6" (2286) 83 1/4" (2115)										
7'-11 1/2" (2426) 8'-0" (2438) 89 1/4" (2267)										

- "Window Dimension" always refers to outside frame to frame dimension.
- "Minimum Rough Opening" dimensions may need to be increased to allow for use of building wraps, flashing, sill panning, brackets, fasteners or other items. See page 109 for more details.
- Dimensions in parentheses are in millimeters.

Picture and Single Transom Window Area Specifications

Window Number	Glass Area Sq. Ft./ (m ²)	Overall Window Area Sq. Ft./ (m ²)
1010	0.19 (0.02)	0.92 (0.09)
1016	0.41 (0.04)	1.40 (0.13)
1020	0.63 (0.06)	1.88 (0.17)
1026	0.85 (0.08)	2.36 (0.22)
1030	1.07 (0.10)	2.84 (0.26)
1036	1.29 (0.12)	3.31 (0.31)
1040	1.50 (0.14)	3.79 (0.35)
1046	1.72 (0.16)	4.27 (0.40)
1050	1.94 (0.18)	4.75 (0.44)
1056	2.16 (0.20)	5.23 (0.49)
1060	2.38 (0.22)	5.71 (0.53)
1066	2.60 (0.24)	6.19 (0.57)
1070	2.82 (0.26)	6.67 (0.62)
1076	3.04 (0.28)	7.15 (0.66)
1080	3.25 (0.30)	7.63 (0.71)
1610	0.41 (0.04)	1.40 (0.13)
1616	0.88 (0.08)	2.13 (0.20)
1620	1.35 (0.13)	2.86 (0.27)
1626	1.82 (0.17)	3.59 (0.33)
1630	2.29 (0.21)	4.31 (0.40)
1636	2.75 (0.26)	5.04 (0.47)
1640	3.22 (0.30)	5.77 (0.54)
1646	3.69 (0.34)	6.50 (0.60)

Window Number	Glass Area Sq. Ft./ (m ²)	Overall Window Area Sq. Ft./ (m ²)
1650	4.16 (0.39)	7.23 (0.67)
1656	4.63 (0.43)	7.96 (0.74)
1660	5.10 (0.47)	8.69 (0.81)
1666	5.57 (0.52)	9.42 (0.87)
1670	6.04 (0.56)	10.15 (0.94)
1676	6.50 (0.60)	10.88 (1.01)
1680	6.97 (0.65)	11.61 (1.08)
2010	0.63 (0.06)	1.88 (0.17)
2016	1.35 (0.13)	2.86 (0.27)
2020	2.07 (0.19)	3.84 (0.36)
2026	2.79 (0.26)	4.81 (0.45)
2030	3.50 (0.33)	5.79 (0.54)
2036	4.22 (0.39)	6.77 (0.63)
2040	4.94 (0.46)	7.75 (0.72)
2046	5.66 (0.53)	8.73 (0.81)
2050	6.38 (0.59)	9.71 (0.90)
2056	7.10 (0.66)	10.69 (0.99)
2060	7.82 (0.73)	11.67 (1.08)
2066	8.54 (0.79)	12.65 (1.17)
2070	9.25 (0.86)	13.63 (1.27)
2076	9.97 (0.93)	14.61 (1.36)
2080	10.69 (0.99)	15.59 (1.45)
2610	0.85 (0.08)	2.36 (0.22)

Window Number	Glass Area Sq. Ft./ (m ²)	Overall Window Area Sq. Ft./ (m ²)
2616	1.82 (0.17)	3.59 (0.33)
2620	2.79 (0.26)	4.81 (0.45)
2626	3.75 (0.35)	6.04 (0.56)
2630	4.72 (0.44)	7.27 (0.68)
2636	5.69 (0.53)	8.50 (0.79)
2640	6.66 (0.62)	9.73 (0.90)
2646	7.63 (0.71)	10.96 (1.02)
2650	8.60 (0.80)	12.19 (1.13)
2656	9.57 (0.89)	13.42 (1.25)
2660	10.54 (0.98)	14.65 (1.36)
2666	11.50 (1.07)	15.88 (1.47)
2670	12.47 (1.16)	17.11 (1.59)
2676	13.44 (1.25)	18.34 (1.70)
2680	14.41 (1.34)	19.56 (1.82)
3010	1.07 (0.10)	2.84 (0.26)
3016	2.29 (0.21)	4.31 (0.40)
3020	3.50 (0.33)	5.79 (0.54)
3026	4.72 (0.44)	7.27 (0.68)
3030	5.94 (0.55)	8.75 (0.81)
3036	7.16 (0.67)	10.23 (0.95)
3040	8.38 (0.78)	11.71 (1.09)

• Dimensions in parentheses are in square meters.

continued on next page

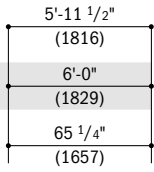

Custom-size windows are available in 1/8" (3) increments. See page 90 for custom sizes and specifications.



6070



6076

Details shown on pages 81-83. Grille patterns shown on page 77.

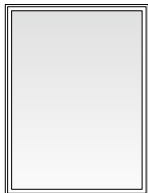

6080

- * "Window Dimension" always refers to outside frame to frame dimension.
- * "Minimum Rough Opening" dimensions may need to be increased to allow for use of building wraps, flashing, sill panning, brackets, fasteners or other items. See page 109 for more details.
- * Dimensions in parentheses are in millimeters.

Picture and Single Transom Window Area Specifications (continued)

Window Number	Glass Area Sq. Ft./ (m ²)	Overall Window Area Sq. Ft./ (m ²)
3046	9.60 (0.89)	13.19 (1.23)
3050	10.82 (1.00)	14.67 (1.36)
3056	12.04 (1.12)	16.15 (1.50)
3060	13.25 (1.23)	17.63 (1.64)
3066	14.47 (1.34)	19.11 (1.77)
3070	15.69 (1.46)	20.59 (1.91)
3076	16.91 (1.57)	22.06 (2.05)
3080	18.13 (1.68)	23.54 (2.19)
3610	1.29 (0.12)	3.31 (0.31)
3616	2.75 (0.26)	5.04 (0.47)
3620	4.22 (0.39)	6.77 (0.63)
3626	5.69 (0.53)	8.50 (0.79)
3630	7.16 (0.67)	10.23 (0.95)
3636	8.63 (0.80)	11.96 (1.11)
3640	10.10 (0.94)	13.69 (1.27)
3646	11.57 (1.07)	15.42 (1.43)
3650	13.04 (1.21)	17.15 (1.59)
3656	14.50 (1.35)	18.88 (1.75)
3660	15.97 (1.48)	20.61 (1.91)
3666	17.44 (1.62)	22.34 (2.07)
3670	18.91 (1.76)	24.06 (2.24)
3676	20.38 (1.89)	25.79 (2.40)
3680	21.85 (2.03)	27.52 (2.56)

Window Number	Glass Area Sq. Ft./ (m ²)	Overall Window Area Sq. Ft./ (m ²)
4010	1.50 (0.14)	3.79 (0.35)
4016	3.22 (0.30)	5.77 (0.54)
4020	4.94 (0.46)	7.75 (0.72)
4026	6.66 (0.62)	9.73 (0.90)
4030	8.38 (0.78)	11.71 (1.09)
4036	10.10 (0.94)	13.69 (1.27)
4040	11.82 (1.10)	15.67 (1.46)
4046	13.54 (1.26)	17.65 (1.64)
4050	15.25 (1.42)	19.63 (1.82)
4056	16.97 (1.58)	21.61 (2.01)
4060	18.69 (1.74)	23.59 (2.19)
4066	20.41 (1.90)	25.56 (2.37)
4070	22.13 (2.06)	27.54 (2.56)
4076	23.85 (2.22)	29.52 (2.74)
4080	25.57 (2.38)	31.50 (2.93)
4610	1.72 (0.16)	4.27 (0.40)
4616	3.69 (0.34)	6.50 (0.60)
4620	5.66 (0.53)	8.73 (0.81)
4626	7.63 (0.71)	10.96 (1.02)
4630	9.60 (0.89)	13.19 (1.23)
4636	11.57 (1.07)	15.42 (1.43)
4640	13.54 (1.26)	17.65 (1.64)
4646	15.50 (1.44)	19.88 (1.85)
4650	17.47 (1.62)	22.11 (2.05)
4656	19.44 (1.81)	24.34 (2.26)
4660	21.41 (1.99)	26.56 (2.47)
4666	23.38 (2.17)	28.79 (2.67)
4670	25.35 (2.35)	31.02 (2.88)
4676	27.32 (2.54)	33.25 (3.09)
4680	29.29 (2.72)	35.48 (3.30)
5010	1.94 (0.18)	4.75 (0.44)
5016	4.16 (0.39)	7.23 (0.67)
5020	6.38 (0.59)	9.71 (0.90)
5026	8.60 (0.80)	12.19 (1.13)
5030	10.82 (1.00)	14.67 (1.36)
5036	13.04 (1.21)	17.15 (1.59)
5040	15.25 (1.42)	19.63 (1.82)
5046	17.47 (1.62)	22.11 (2.05)
5050	19.69 (1.83)	24.59 (2.28)
5056	21.91 (2.04)	27.06 (2.51)
5060	24.13 (2.24)	29.54 (2.74)
5066	26.35 (2.45)	32.02 (2.97)
5070	28.57 (2.65)	34.50 (3.21)
5076	30.79 (2.86)	36.98 (3.44)
5080	33.00 (3.07)	39.46 (3.67)
5610	2.16 (0.20)	5.23 (0.49)
5616	4.63 (0.43)	7.96 (0.74)
5620	7.10 (0.66)	10.69 (0.99)
5626	9.57 (0.89)	13.42 (1.25)
5630	12.04 (1.12)	16.15 (1.50)
5636	14.50 (1.35)	18.88 (1.75)
5640	16.97 (1.58)	21.61 (2.01)
5646	19.44 (1.81)	24.34 (2.26)
5650	21.91 (2.04)	27.06 (2.51)
5656	24.38 (2.26)	29.79 (2.77)
5660	26.85 (2.49)	32.52 (3.02)
5666	29.32 (2.72)	35.25 (3.27)
5670	31.79 (2.95)	37.98 (3.53)
5676	34.25 (3.18)	40.71 (3.78)
5680	36.72 (3.41)	43.44 (4.04)

Window Number	Glass Area Sq. Ft./ (m ²)	Overall Window Area Sq. Ft./ (m ²)
6010	2.38 (0.22)	5.71 (0.53)
6016	5.10 (0.47)	8.69 (0.81)
6020	7.82 (0.73)	11.67 (1.08)
6026	10.54 (0.98)	14.65 (1.36)
6030	13.25 (1.23)	17.63 (1.64)
6036	15.97 (1.48)	20.61 (1.91)
6040	18.69 (1.74)	23.59 (2.19)
6046	21.41 (1.99)	26.56 (2.47)
6050	24.13 (2.24)	29.54 (2.74)
6056	26.85 (2.49)	32.52 (3.02)
6060	29.57 (2.75)	35.50 (3.30)
6066	32.29 (3.00)	38.48 (3.57)
6070	35.00 (3.25)	41.46 (3.85)
6076	37.72 (3.50)	44.44 (4.13)
6080	40.44 (3.76)	47.42 (4.41)
6610	2.60 (0.24)	6.19 (0.57)
6616	5.57 (0.52)	9.42 (0.87)
6620	8.54 (0.79)	12.65 (1.17)
6626	11.50 (1.07)	15.88 (1.47)
6630	14.47 (1.34)	19.11 (1.77)
6636	17.44 (1.62)	22.34 (2.07)
6640	20.41 (1.90)	25.56 (2.37)
6646	23.38 (2.17)	28.79 (2.67)
6650	26.35 (2.45)	32.02 (2.97)
6656	29.32 (2.72)	35.25 (3.27)
6660	32.29 (3.00)	38.48 (3.57)
7010	2.82 (0.26)	6.67 (0.62)
7016	6.04 (0.56)	10.15 (0.94)
7020	9.25 (0.86)	13.63 (1.27)
7026	12.47 (1.16)	17.11 (1.59)
7030	15.69 (1.46)	20.59 (1.91)
7036	18.91 (1.76)	24.06 (2.24)
7040	22.13 (2.06)	27.54 (2.56)
7046	25.35 (2.35)	31.02 (2.88)
7050	28.57 (2.65)	34.50 (3.21)
7056	31.79 (2.95)	37.98 (3.53)
7060	35.00 (3.25)	41.46 (3.85)
7610	3.04 (0.28)	7.15 (0.66)
7616	6.50 (0.60)	10.88 (1.01)
7620	9.97 (0.93)	14.61 (1.36)
7626	13.44 (1.25)	18.34 (1.70)
7630	16.91 (1.57)	22.06 (2.05)
7636	20.38 (1.89)	25.79 (2.40)
7640	23.85 (2.22)	29.52 (2.74)
7646	27.32 (2.54)	33.25 (3.09)
7650	30.79 (2.86)	36.98 (3.44)
7656	34.25 (3.18)	40.71 (3.78)
7660	37.72 (3.50)	44.44 (4.13)
8010	3.25 (0.30)	7.63 (0.71)
8016	6.97 (0.65)	11.61 (1.08)
8020	10.69 (0.99)	15.59 (1.45)
8026	14.41 (1.34)	19.56 (1.82)
8030	18.13 (1.68)	23.54 (2.19)
8036	21.85 (2.03)	27.52 (2.56)
8040	25.57 (2.38)	31.50 (2.93)
8046	29.29 (2.72)	35.48 (3.30)
8050	33.00 (3.07)	39.46 (3.67)
8056	36.72 (3.41)	43.44 (4.04)
8060	40.44 (3.76)	47.42 (4.41)

* Dimensions in parentheses are in square meters.

PICTURE, TRANSOM & SPECIALTY WINDOWS

Table of Twin and Triple Transom Window Sizes

Scale 1/8" (3) = 1'-0" (305) – 1:96

Window Dimension	2'-11 1/2" (902)	3'-5 1/2" (1054)	3'-11 1/2" (1207)	4'-5 1/2" (1359)	4'-11 1/2" (1511)	5'-5 1/2" (1664)	5'-11 1/2" (1816)	6'-11 1/2" (2121)
Minimum Rough Opening	3'-0" (914)	3'-6" (1067)	4'-0" (1219)	4'-6" (1372)	5'-0" (1524)	5'-6" (1676)	6'-0" (1829)	7'-0" (2134)
Unobstructed Glass (width of twin single sash)	11 1/4" (286)	14 1/4" (362)	17 1/4" (438)	20 1/4" (514)	23 1/4" (591)	26 1/4" (667)	29 1/4" (743)	35 1/4" (895)
Unobstructed Glass (width of triple single sash)				11 1/4" (286)			17 1/4" (438)	

CUSTOM WIDTHS TWIN – 35 1/2" to 95 1/2" TRIPLE – 53 1/2" to 143 1/2"

CUSTOM HEIGHTS – 11 1/2" to 23 1/2"

11 1/2" (292)	1610-2	1910-2	2010-2	2310-2	2610-2	2910-2	3010-2	3610-2
1'-5 1/2" (445)	1616-2	1916-2	2016-2	2316-2	2616-2	2916-2	3016-2	3616-2
1'-11 1/2" (597)	1620-2	1920-2	2020-2	2320-2	2620-2	2920-2	3020-2	3620-2
				1610-3			2010-3	
				1616-3			2016-3	
				1620-3			2020-3	

- * "Window Dimension" always refers to outside frame to frame dimension.
- * "Minimum Rough Opening" dimensions may need to be increased to allow for use of building wraps, flashing, sill panning, brackets, fasteners or other items. See page 109 for more details.
- * Dimensions in parentheses are in millimeters.

Twin Transom Window Area Specifications

Window Number	Glass Area Sq. Ft./ (m ²)	Overall Window Area Sq. Ft./ (m ²)
1610-2	0.82 (0.08)	2.84 (0.26)
1910-2	1.04 (0.10)	3.31 (0.31)
2010-2	1.26 (0.12)	3.79 (0.35)
2310-2	1.48 (0.14)	4.27 (0.40)
2610-2	1.70 (0.16)	4.75 (0.44)
2910-2	1.91 (0.18)	5.23 (0.49)
3010-2	2.13 (0.20)	5.71 (0.53)
3610-2	2.57 (0.24)	6.67 (0.62)
4010-2	3.01 (0.28)	7.63 (0.71)
1616-2	1.76 (0.16)	4.31 (0.40)
1916-2	2.23 (0.21)	5.04 (0.47)
2016-2	2.70 (0.25)	5.77 (0.54)
2316-2	3.16 (0.29)	6.50 (0.60)
2616-2	3.63 (0.34)	7.23 (0.67)
2916-2	4.10 (0.38)	7.96 (0.74)
3016-2	4.57 (0.42)	8.69 (0.81)
3616-2	5.51 (0.51)	10.15 (0.94)
4016-2	6.45 (0.60)	11.61 (1.08)
1620-2	2.70 (0.25)	5.79 (0.54)
1920-2	3.41 (0.32)	6.77 (0.63)
2020-2	4.13 (0.38)	7.75 (0.72)
2320-2	4.85 (0.45)	8.73 (0.81)
2620-2	5.57 (0.52)	9.71 (0.90)
2920-2	6.29 (0.58)	10.69 (0.99)
3020-2	7.01 (0.65)	11.67 (1.08)
3620-2	8.45 (0.78)	13.63 (1.27)
4020-2	9.88 (0.92)	15.59 (1.45)

Triple Transom Window Area Specifications

Window Number	Glass Area Sq. Ft./ (m ²)	Overall Window Area Sq. Ft./ (m ²)
1610-3	1.23 (0.11)	4.27 (0.40)
2010-3	1.89 (0.18)	5.71 (0.53)
2610-3	2.54 (0.24)	7.15 (0.66)
3010-3	3.20 (0.30)	8.59 (0.80)
3610-3	3.86 (0.36)	10.02 (0.93)
4010-3	4.51 (0.42)	11.46 (1.06)
1616-3	2.64 (0.24)	6.50 (0.60)
2016-3	4.04 (0.38)	8.69 (0.81)
2616-3	5.45 (0.51)	10.88 (1.01)
3016-3	6.86 (0.64)	13.06 (1.21)
3616-3	8.26 (0.77)	15.25 (1.42)
4016-3	9.67 (0.90)	17.44 (1.62)
1620-3	4.04 (0.38)	8.73 (0.81)
2020-3	6.20 (0.58)	11.67 (1.08)
2620-3	8.36 (0.78)	14.61 (1.36)
3020-3	10.51 (0.98)	17.54 (1.63)
3620-3	12.67 (1.18)	20.48 (1.90)
4020-3	14.82 (1.38)	23.42 (2.18)

Half Circle Window Area Specifications

Window Number	Glass Area Sq. Ft./ (m ²)	Overall Window Area Sq. Ft./ (m ²)
20	0.80 (0.07)	2.02 (0.19)
26	1.46 (0.14)	3.01 (0.28)
30	2.32 (0.22)	4.21 (0.39)
36	3.37 (0.31)	5.60 (0.52)
40	4.62 (0.43)	7.18 (0.67)
46	6.06 (0.56)	8.97 (0.83)
50	7.70 (0.72)	10.95 (1.02)
56	9.54 (0.89)	13.12 (1.22)
60	11.58 (1.08)	15.49 (1.44)
66	13.81 (1.28)	18.06 (1.68)
70	16.23 (1.51)	20.83 (1.93)
76	18.85 (1.75)	23.79 (2.21)
80	21.67 (2.01)	26.94 (2.50)

Circle Window Area Specifications

Window Number	Glass Area Sq. Ft./ (m ²)	Overall Window Area Sq. Ft./ (m ²)
2020	1.61 (0.15)	3.01 (0.28)
2626	2.93 (0.27)	4.75 (0.44)
3030	4.65 (0.43)	6.87 (0.64)
3636	6.75 (0.63)	9.39 (0.87)
4040	9.25 (0.86)	12.31 (1.14)

* Dimensions in parentheses are in square meters.

Notes on this page also apply to the previous page.

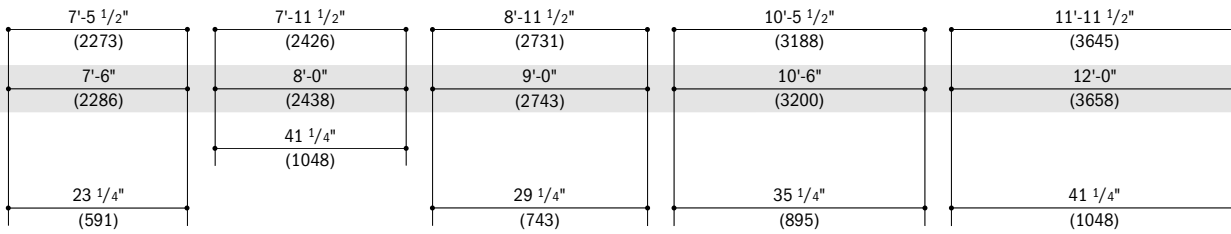

Custom-size windows are available in 1/8" (3) increments. See page 90 for custom sizes and specifications.

Windows have one continuous outer frame.

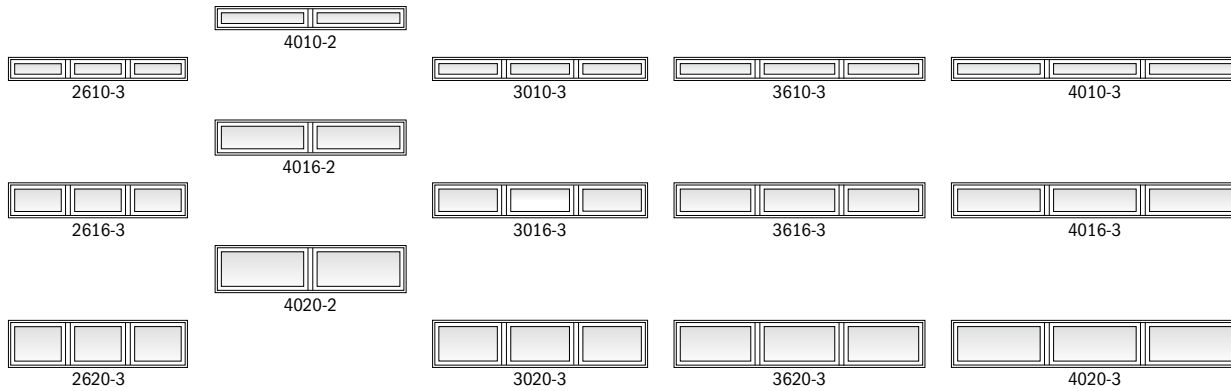

- "Window Dimension" always refers to outside frame to frame dimension.
- "Minimum Rough Opening" dimensions may need to be increased to allow for use of building wraps, flashing, sill panning, brackets, fasteners or other items. See page 109 for more details.
- Dimensions in parentheses are in millimeters.

Quarter Circle Window Area Specifications

Window Number	Glass Area Sq. Ft./ (m ²)	Overall Window Area Sq. Ft./ (m ²)
1616	0.69 (0.06)	1.82 (0.17)
2020	1.62 (0.15)	3.22 (0.30)
2626	2.95 (0.27)	5.01 (0.47)
3030	4.67 (0.43)	7.19 (0.67)
3636	6.78 (0.63)	9.77 (0.91)
4040	9.28 (0.86)	12.73 (1.18)
4646	12.18 (1.13)	16.09 (1.50)
5050	15.47 (1.44)	19.85 (1.84)

Window Number	Glass Area Sq. Ft./ (m ²)	Overall Window Area Sq. Ft./ (m ²)
2650	10.54 (0.98)	14.56 (1.35)
3020	6.45 (0.60)	9.23 (0.86)
3026	7.66 (0.71)	10.71 (0.99)
3030	8.88 (0.82)	12.19 (1.13)
3036	10.10 (0.94)	13.67 (1.27)
3040	11.31 (1.05)	15.15 (1.41)
3046	12.53 (1.16)	16.63 (1.54)
3050	13.74 (1.28)	18.11 (1.68)
3620	8.35 (0.78)	11.47 (1.07)
3626	9.81 (0.91)	13.20 (1.23)
3630	11.28 (1.05)	14.93 (1.39)
3636	12.75 (1.18)	16.66 (1.55)
3640	14.21 (1.32)	18.39 (1.71)
3646	15.68 (1.46)	20.12 (1.87)
3650	17.14 (1.59)	21.84 (2.03)
4020	10.45 (0.97)	13.90 (1.29)
4026	12.16 (1.13)	15.88 (1.48)
4030	13.88 (1.29)	17.86 (1.66)
4036	15.59 (1.45)	19.84 (1.84)
4040	17.31 (1.61)	21.82 (2.03)
4046	19.03 (1.77)	23.80 (2.21)
4050	20.74 (1.93)	25.78 (2.40)
4620	12.74 (1.18)	16.54 (1.54)
4626	14.71 (1.37)	18.77 (1.74)
4630	16.67 (1.55)	20.99 (1.95)
4636	18.64 (1.73)	23.22 (2.16)
4640	20.60 (1.91)	25.45 (2.36)

Window Number	Glass Area Sq. Ft./ (m ²)	Overall Window Area Sq. Ft./ (m ²)
4646	22.57 (2.10)	27.68 (2.57)
4650	24.54 (2.28)	29.91 (2.78)
5020	15.23 (1.41)	19.36 (1.80)
5026	17.45 (1.62)	21.84 (2.03)
5030	19.66 (1.83)	24.32 (2.26)
5036	21.88 (2.03)	26.80 (2.49)
5040	24.09 (2.24)	29.28 (2.72)
5046	26.31 (2.44)	31.76 (2.95)
5050	28.53 (2.65)	34.24 (3.18)
5620	17.92 (1.66)	22.39 (2.08)
5626	20.38 (1.89)	25.12 (2.33)
5630	22.85 (2.12)	27.85 (2.59)
5636	25.31 (2.35)	30.58 (2.84)
5640	27.78 (2.58)	33.31 (3.09)
5646	30.25 (2.81)	36.03 (3.35)
5650	32.71 (3.04)	38.76 (3.60)
6020	20.80 (1.93)	25.61 (2.38)
6026	23.51 (2.18)	28.59 (2.66)
6030	26.23 (2.44)	31.57 (2.93)
6036	28.95 (2.69)	34.55 (3.21)
6040	31.66 (2.94)	37.53 (3.49)
6046	34.38 (3.19)	40.51 (3.76)
6050	37.10 (3.45)	43.48 (4.04)

• Dimensions in parentheses are in square meters.

For arch window specifications, see page 80.

Springline™ Window Area Specifications

Window Number	Glass Area Sq. Ft./ (m ²)	Overall Window Area Sq. Ft./ (m ²)
2020	3.23 (0.30)	5.34 (0.50)
2026	3.95 (0.37)	6.32 (0.59)
2030	4.67 (0.43)	7.30 (0.68)
2036	5.38 (0.50)	8.28 (0.77)
2040	6.10 (0.57)	9.26 (0.86)
2046	6.81 (0.63)	10.24 (0.95)
2050	7.53 (0.70)	11.22 (1.04)
2620	4.74 (0.44)	7.19 (0.67)
2626	5.71 (0.53)	8.42 (0.78)
2630	6.67 (0.62)	9.65 (0.90)
2636	7.64 (0.71)	10.87 (1.01)
2640	8.61 (0.80)	12.10 (1.12)
2646	9.57 (0.89)	13.33 (1.24)

PICTURE, TRANSOM & SPECIALTY WINDOWS

Table of Half Circle Window Sizes

Scale 1/8" (3) = 1'-0" (305) – 1:96

Window Dimension	1'-11 1/2" (597)	2'-5 1/2" (749)	2'-11 1/2" (902)
Minimum Rough Opening	2'-0" (610)	2'-6" (762)	3'-0" (914)
Unobstructed Glass	17 1/4" (438)	23 1/4" (591)	29 1/4" (743)
Radius	11 3/4" (298)	14 3/4" (375)	17 3/4" (451)
1'-2 7/8" (378)	1'-3 3/8" (391)	1'-5 7/8" (454)	1'-8 7/8" (530)
8 5/8" (219)	11 5/8" (295)	14 5/8" (371)	17 3/4" (451)
20	26	30	
3'-5 1/2" (1054)	3'-11 1/2" (1207)	4'-5 1/2" (1359)	
3'-6" (1067)	4'-0" (1219)	4'-6" (1372)	
35 1/4" (895)	41 1/4" (1048)	47 1/4" (1200)	
20 3/4" (527)	23 3/4" (603)	26 3/4" (679)	
1'-11 7/8" (606)	2'-2 7/8" (683)	2'-5 7/8" (759)	2'-8 7/8" (835)
2'-0 3/8" (619)	2'-3 3/8" (695)	2'-6 3/8" (772)	2'-9 3/8" (848)
17 5/8" (448)	20 5/8" (524)	23 5/8" (600)	26 5/8" (676)
36	40	46	
4'-11 1/2" (1511)	5'-5 1/2" (1664)	5'-11 1/2" (1816)	6'-5 1/2" (1969)
5'-0" (1524)	5'-6" (1676)	6'-0" (1829)	6'-6" (1981)
53 1/4" (1353)	59 1/4" (1505)	65 1/4" (1657)	71 1/4" (1810)
29 3/4" (756)	32 3/4" (832)	35 3/4" (908)	38 3/4" (984)
2'-8 7/8" (835)	2'-11 7/8" (911)	3'-2 7/8" (987)	3'-5 7/8" (1064)
2'-9 3/8" (848)	3'-0 3/8" (924)	3'-3 3/8" (1000)	3'-6 3/8" (1076)
26 5/8" (676)	29 5/8" (752)	32 5/8" (829)	35 5/8" (905)
50	56	60	66
6'-11 1/2" (2121)	7'-5 1/2" (2273)	7'-11 1/2" (2426)	
7'-0" (2134)	7'-6" (2286)	8'-0" (2438)	
77 1/4" (1962)	83 1/4" (2115)	89 1/4" (2267)	
41 3/4" (1060)	44 3/4" (1137)	47 3/4" (1213)	
3'-8 7/8" (1140)	3'-11 7/8" (1216)	4'-2 7/8" (1292)	4'-5 7/8" (1133)
3'-9 3/8" (1153)	4'-0 3/8" (1229)	4'-3 3/8" (1305)	4'-6 3/8" (1381)
38 5/8" (981)	41 5/8" (1057)	44 5/8" (1133)	47 5/8" (1209)
70	76	80	







Custom-size half circle windows are available in 1/8" (3) increments. Contact your Andersen supplier for more information.

Details shown on pages 81-83.
Grille patterns shown on page 77.

• "Window Dimension" always refers to outside frame to frame dimension.
• "Minimum Rough Opening" dimensions may need to be increased to allow for use of building wraps, flashing, sill panning, brackets, fasteners or other items. See page 109 for more details.
• Dimensions in parentheses are in millimeters.

Table of Circle Window Sizes

Scale 1/8" (3) = 1'-0" (305) – 1:96

Window Dimension	1'-11 1/2" (597)	2'-5 1/2" (749)	2'-11 1/2" (902)	3'-5 1/2" (1054)	3'-11 1/2" (1207)
Minimum Rough Opening	2'-0" (610)	2'-6" (762)	3'-0" (914)	3'-6" (1067)	4'-0" (1219)
Unobstructed Glass	17 1/4" (438)	23 1/4" (591)	29 1/4" (743)	35 1/4" (895)	41 1/4" (1048)
	 2020	 2626	 3030	 3636	 4040









Custom-size circle and quarter circle windows are available in 1/8" (3) increments. Contact your Andersen supplier for more information.

Details shown on pages 81-83.

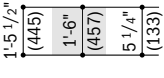
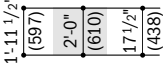
Grille patterns shown on page 77.

Table of Quarter Circle Window Sizes

Scale 1/8" (3) = 1'-0" (305) – 1:96

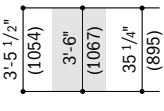
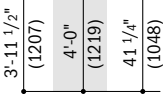
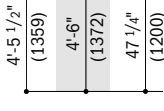
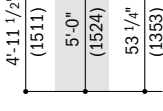
Window Dimension	1'-5 1/2" (445)	1'-11 1/2" (597)	2'-5 1/2" (749)	2'-11 1/2" (902)
Minimum Rough Opening	1'-6" (457)	2'-0" (610)	2'-6" (762)	3'-0" (914)
Unobstructed Glass	5 1/4" (133)	17 1/2" (438)	23 1/4" (591)	29 1/4" (743)
Radius	14 3/8" (365)	20 3/8" (518)	26 3/8" (670)	32 3/8" (822)
 1616	 2020	 2626	 3030	
 3636	 4040	 4646	 5050	
 3636	 4040	 4646	 5050	

100 Series
Picture, Transom &
Specialty Windows

• "Window Dimension" always refers to outside frame to frame dimension.
 • "Minimum Rough Opening" dimensions may need to be increased to allow for use of building wraps, flashing, sill panning, brackets, fasteners or other items. See page 109 for more details.
 • Dimensions in parentheses are in millimeters.

PICTURE, TRANSOM & SPECIALTY WINDOWS



These custom shapes are available in 1/8" (3) increments.

Design Criteria

Listed for each custom shape are factors that must be considered when deciding on a custom-shaped specialty window.

Details shown on pages 81-83.

Grilles are available for most shapes and sizes in colonial and specified equal divided light patterns. For more information on divided light, see page 13 or contact your Andersen supplier.

Custom Unequal Leg Arch

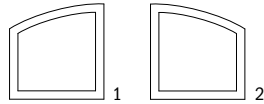

Choose left-facing (1) or right-facing (2) as viewed from the exterior. Contains unequal legs, two right angles at the sill and an arch at the top.

Custom-size design limitations:

Min/Max Window Width
17 1/2" (445) to 95 1/2" (2426)

Min/Max Window Height
11 3/8" (289) to 95 1/2" (2426)

Min/Max Short Side Height
9 3/4" (248) to 93 7/8" (2384)

Max Frame Area: 40 sq. ft. or 3.7 m²

Based on the smallest square or rectangular shape that covers the entire window.

Additional limitations may apply. Contact your Andersen supplier for more information.

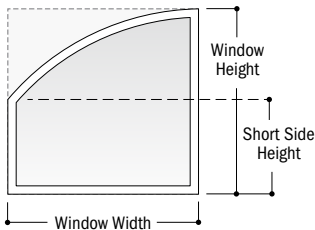

Custom Trapezoid

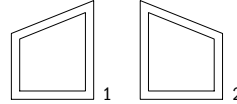

Choose left-facing (1) or right-facing (2) as viewed from the exterior. Contains a slope to the left or right. Slope is often designed to match a roof's pitch.

Custom-size design limitations:

Min/Max Window Width
17 1/2" (445) to 107 1/2" (2731)

Min/Max Window Height
9 7/8" (251) to 95 1/2" (2426)

Min/Max Short Side Height
9 3/4" (248) to 95 3/8" (2423)

Max Frame Area: 40 sq. ft. or 3.7 m²

Based on the smallest square or rectangular shape that covers the entire window.

Additional limitations may apply. Contact your Andersen supplier for more information.

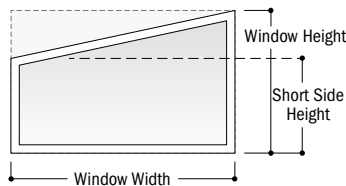

Custom Peak Pentagon

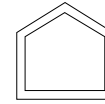

Contains sides of equal length, extending at right angles from the sill, and two angled sides, of equal length, that peak above center of sill.

Custom-size design limitations:

Min/Max Window Width
17 1/2" (445) to 107 1/2" (2731)

Min/Max Window Height
14 1/8" (359) to 107 1/2" (2731)

Min/Max Side Height
9 3/4" (248) to 94 1/8" (2391)

Max Frame Area: 40 sq. ft. or 3.7 m²

Based on the smallest square or rectangular shape that covers the entire window.

Additional limitations may apply. Contact your Andersen supplier for more information.

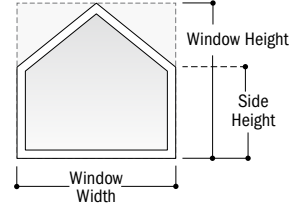

*Dimensions in parentheses are in millimeters.

Custom Angled Pentagon

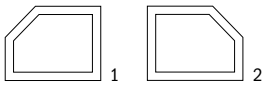

Choose left-facing (1) or right-facing (2) as viewed from the exterior. Contains an angle cut, or a "clipped corner" sloping to the left or right.

Custom-size design limitations:

Min/Max Window Width
17 1/2" (445) to 107 1/2" (2731)

Min/Max Top Width
9 3/4" (248) to 107 3/8" (2727)

Min/Max Window Height
14 3/8" (365) to 107 1/2" (2731)

Min/Max Short Side Height
9 3/4" (248) to 94 1/8" (226)

Max Frame Area: 40 sq. ft. or 3.7 m²
Based on the smallest square or rectangular shape that covers the entire window.

Additional limitations may apply. Contact your Andersen supplier for more information.

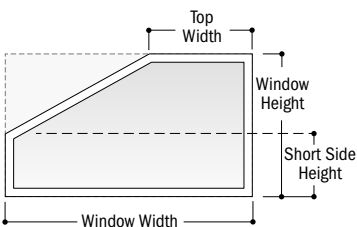

Custom Octagon

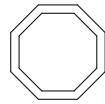

Contains eight equal angles and sides.

Custom-size design limitations:

Min/Max Window Width
23 1/2" (597) to 71 1/2" (1816)

Min/Max Window Height
23 1/2" (597) to 71 1/2" (1816)

Additional limitations may apply. Contact your Andersen supplier for more information.

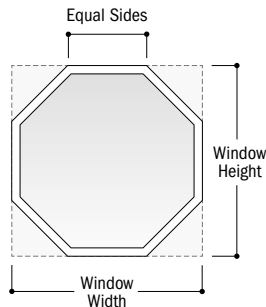

Custom Right Triangle

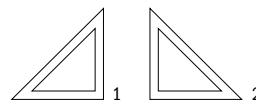

Choose left-facing (1) or right-facing (2) as viewed from the exterior. Contains one 90-degree angle.

Custom-size design limitations:

Min/Max Window Width
17 1/2" (445) to 95 1/2" (2426)

Min/Max Window Height
17 1/2" (445) to 95 1/2" (2426)

Max Frame Area: 40 sq. ft. or 3.7 m²
Based on the smallest square or rectangular shape that covers the entire window.

Additional limitations may apply. Contact your Andersen supplier for more information.

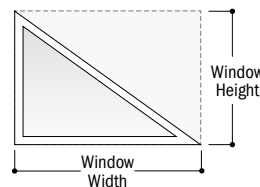

Custom Isosceles Triangle

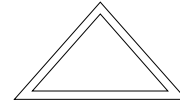

Contains two sides of equal length and two equal angles.

Custom-size design limitations:

Min/Max Window Width
17 1/2" (445) to 107 1/2" (2731)

Min/Max Window Height
17 1/2" (445) to 75 7/8" (1927)

Max Frame Area: 40 sq. ft. or 3.7 m²
Based on the smallest square or rectangular shape that covers the entire window.

Additional limitations may apply. Contact your Andersen supplier for more information.

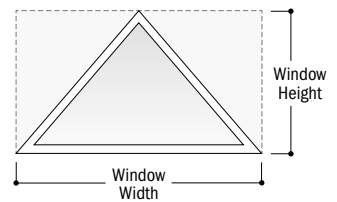

* Dimensions in parentheses are in millimeters.

PICTURE, TRANSOM & SPECIALTY WINDOWS

Table of Springline™ Window Sizes

Scale 1/8" (3) = 1'-0" (305) – 1:96

Notes on the next page also apply to this page.

Window Width Dimension	1'-11 1/2" (597)	2'-5 1/2" (749)	2'-11 1/2" (902)	3'-5 1/2" (1054)	3'-11 1/2" (1207)	4'-5 1/2" (1359)	4'-11 1/2" (1511)
Minimum Rough Opening	2'-0" (610)	2'-6" (762)	3'-0" (914)	3'-6" (1067)	4'-0" (1219)	4'-6" (1372)	5'-0" (1524)
Unobstructed Glass	17 1/4" (438)	23 1/4" (591)	29 1/4" (743)	35 1/4" (895)	41 1/4" (1048)	47 1/4" (1200)	53 1/4" (1353)

Window height shown in table

CUSTOM SIZES AVAILABLE

Radius	11 3/4" (298)	14 3/4" (375)	17 3/4" (451)	20 3/4" (527)	23 3/4" (603)	26 3/4" (679)	29 3/4" (756)	
Chord Height	11 3/4" (298)	14 3/4" (375)	17 3/4" (451)	20 3/4" (527)	23 3/4" (603)	26 3/4" (679)	29 3/4" (756)	
Side Height	1'-11 1/2" (597)	2'-11 1/4" (895)	3'-2 1/4" (972)	3'-5 1/4" (1048)	3'-8 1/4" (1124)	3'-11 1/4" (1200)	4'-2 1/4" (1276)	4'-5 1/4" (1353)
	2020	2620	3020	3620	4020	4620	5020	
	2'-5 1/2" (749)	3'-5 1/4" (1048)	3'-8 1/4" (1124)	4'-2 1/4" (1276)	4'-5 1/4" (1353)	4'-8 1/4" (1429)	4'-11 1/4" (1505)	
	2026	2626	3026	3626	4026	4626	5026	
	2'-11 1/2" (902)	3'-11 1/4" (1200)	4'-2 1/4" (1276)	4'-8 1/4" (1429)	4'-11 1/4" (1505)	5'-2 1/4" (1581)	5'-5 1/4" (1657)	
	2030	2630	3030	3630	4030	4630	5030	
	3'-5 1/2" (1054)	4'-5 1/4" (1353)	4'-8 1/4" (1429)	5'-2 1/4" (1581)	5'-5 1/4" (1657)	5'-8 1/4" (1734)	5'-11 1/4" (1810)	
	2036	2636	3036	3636	4036	4636	5036	
	3'-11 1/2" (1207)	4'-11 1/4" (1505)	5'-2 1/4" (1581)	5'-8 1/4" (1734)	5'-11 1/4" (1810)	6'-2 1/4" (1886)	6'-5 1/4" (1962)	
	2040	2640	3040	3640	4040	4640	5040	
	4'-5 1/2" (1359)	5'-5 1/4" (1657)	5'-8 1/4" (1734)	6'-2 1/4" (1886)	6'-5 1/4" (1962)	6'-8 1/4" (2038)	6'-11 1/4" (2115)	
	2046	2646	3046	3646	4046	4646	5046	
	4'-11 1/2" (1511)	5'-11 1/4" (1810)	6'-2 1/4" (1886)	6'-8 1/4" (2038)	6'-11 1/4" (2115)	7'-2 1/4" (2191)	7'-5 1/4" (2267)	
	2050	2650	3050	3650	4050	4650	5050	

CUSTOM SIZES AVAILABLE

Unobstructed Glass = window height – 6.25" (159)

Minimum Rough Opening = window height + 1/2" (13)

* "Window Dimension" always refers to outside frame to frame dimension.
 • "Minimum Rough Opening" dimensions may need to be increased to allow for use of building wraps, flashing, sill panning, brackets, fasteners or other items. See page 109 for more details.
 • Dimensions in parentheses are in millimeters.

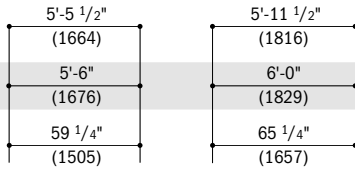

Custom-size windows are available in 1/8" (3) increments. Contact your Andersen supplier for more information.

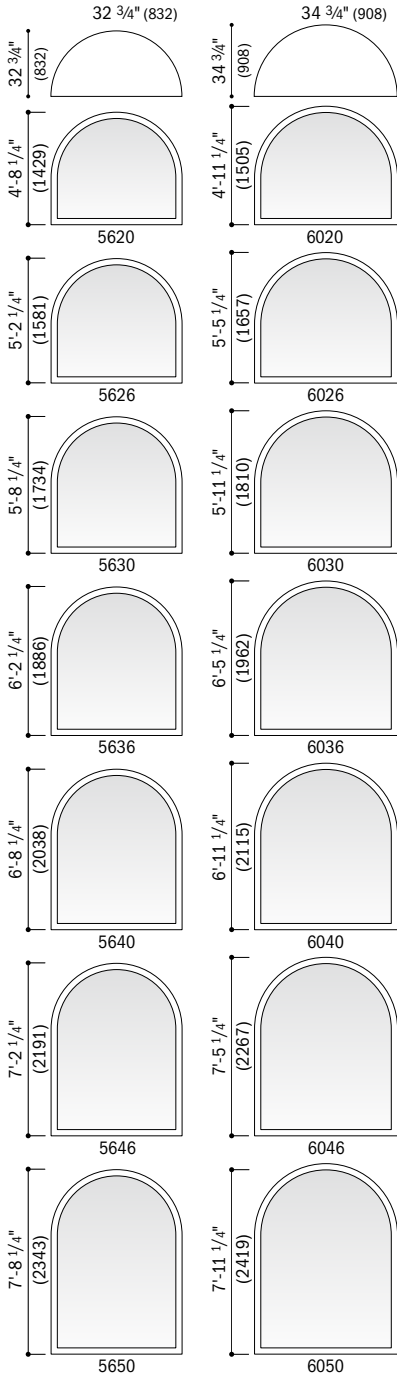

For Springline™ and arch windows, the size designation does not reflect overall window height. (e.g., a 2020 Springline window size has a side height of 1'-11 1/2" and an overall window height of 2'-11 1/4".)

Details shown on pages 81-83.
Grille patterns shown below.

Grille Patterns

	Colonial	Renaissance	Sunburst			
Half Circle						
Quarter Circle						
Circle						
Springline™						
Arch						
	Prairie A	Colonial	Modified Colonial	Tall Fractional	Short Fractional	Victorian
Transom						
Picture						

Number of lights and overall pattern varies with window size. Patterns are not available in all configurations. Specialty window patterns may not align with picture window patterns when joined. Specified equal light pattern is also available for all shapes except quarter circle. For more information on divided light, see page 13 or visit andersenwindows.com/grilles.

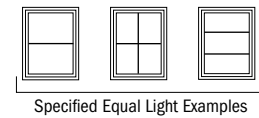

100 Series
Picture, Transom &
Specialty Windows

• "Window Dimension" always refers to outside frame to frame dimension.
• **"Minimum Rough Opening" dimensions may need to be increased to allow for use of building wraps, flashing, sill panning, brackets, fasteners or other items. See page 109 for more details.**
• Dimensions in parentheses are in millimeters.

PICTURE, TRANSOM & SPECIALTY WINDOWS

Table of Arch Window Sizes

Scale 1/8" (3) = 1'-0" (305) – 1:96

Window Width Dimension	1'-11 1/2" (597)	2'-5 1/2" (749)	2'-11 1/2" (902)	3'-5 1/2" (1054)	3'-11 1/2" (1207)	4'-5 1/2" (1359)	4'-11 1/2" (1511)
Minimum Rough Opening	2'-0" (610)	2'-6" (762)	3'-0" (914)	3'-6" (1067)	4'-0" (1219)	4'-6" (1372)	5'-0" (1524)
Unobstructed Glass	17 1/4" (438)	23 1/4" (591)	29 1/4" (743)	35 1/4" (895)	41 1/4" (1048)	47 1/4" (1200)	53 1/4" (1353)

CUSTOM SIZES AVAILABLE

Minimum Rough Opening = window height + 1/2"
(13)

Unobstructed Glass = window height – 6.25"
(159)

CUSTOM SIZES AVAILABLE

Window height shown in table	Radius	23 1/2" (597)	29 1/2" (749)	35 1/2" (902)	41 1/2" (1054)	47 1/2" (1207)	53 1/2" (1359)	59 1/2" (1511)
Chord Height		1'-2 21/32" (524)	1'-3 7/16" (392)	1'-4 3/8" (121)	1'-5 1/16" (433)	1'-5 7/8" (454)	1'-6 21/32" (474)	1'-7 15/32" (495)
Side Height		1'-5 1/2" (445)	1'-9 7/16" (545)	1'-10 1/4" (565)	1'-11 1/16" (586)	1'-11 7/8" (606)	2'-0 21/32" (627)	2'-1 15/32" (647)
		2010	2610	3010	3610	4010	4610	5010
		2016	2616	3016	3616	4016	4616	5016
		2020	2620	3020	3620	4020	4620	5020
		2026	2626	3026	3626	4026	4626	5026
		2030	2630	3030	3630	4030	4630	5030
		2036	2636	3036	3636	4036	4636	5036
		2040	2640	3040	3640	4040	4640	5040
		2046	2646	3046	3646	4046	4646	5046
		2050	2650	3050	3650	4050	4650	5050
		2056	2656	3056	3656	4056	4656	5056
		2060	2660	3060	3660	4060	4660	5060

Notes on page 77 also apply to these pages.

5'-5 1/2"		5'-11 1/2"		6'-5 1/2"		6'-11 1/2"		7'-5 1/2"		7'-11 1/2"	
(1664)		(1816)		(1969)		(2121)		(2273)		(2426)	
5'-6"		6'-0"		6'-6"		7'-0"		7'-6"		8'-0"	
(1676)		(1829)		(1981)		(2134)		(2286)		(2438)	
59 1/4"		65 1/4"		71 1/4"		77 1/4"		83 1/4"		89 1/4"	
(1505)		(1657)		(1810)		(1962)		(2115)		(2267)	
65 1/2" (1664)		71 1/2" (1816)		77 1/2" (1969)		83 1/2" (2121)		89 1/2" (2273)		95 1/2" (2426)	
1'-8 9/32" (515)	9 19/32" (223)	1'-9 3/32" (535)	9 19/32" (243)	1'-9 7/8" (556)	10 3/8" (264)	1'-10 11/16" (576)	11 3/16" (284)	1'-11 1/2" (597)	12" (305)	2'-0 9/32" (617)	12 29/32" (325)
2'-2 9/32" (667)	5610	2'-3 3/32" (688)	6010	2'-3 7/8" (708)	6610	2'-4 11/16" (729)	7010	2'-5 1/2" (749)	7610	2'-6 9/32" (769)	8010
2'-8 9/32" (820)	5616	2'-9 3/32" (840)	6016	2'-9 7/8" (861)	6616	2'-10 11/16" (881)	7016	2'-11 1/2" (901)	7616	3'-0 9/32" (922)	8016
3'-2 9/32" (972)	5626	3'-3 3/32" (993)	6026	3'-3 7/8" (1013)	6626	3'-4 11/16" (1033)	7026	3'-5 1/2" (1054)	7626	3'-6 9/32" (1074)	8026
3'-8 9/32" (1125)	5630	3'-9 3/32" (1145)	6030	3'-9 7/8" (1165)	6630	3'-10 11/16" (1186)	7030	3'-11 1/2" (1206)	7630	4'-0 9/32" (1227)	8030
4'-2 9/32" (1277)	5636	4'-3 3/32" (1297)	6036	4'-3 7/8" (1318)	6636	4'-4 11/16" (1338)	7036	4'-5 1/2" (1359)	7636	4'-6 9/32" (1379)	8036
4'-8 9/32" (1429)	5640	4'-9 3/32" (1450)	6040	4'-9 7/8" (1470)	6640	4'-10 11/16" (1491)	7040	4'-11 1/2" (1511)	7640	5'-0 9/32" (1531)	8040
5'-2 9/32" (1582)	5646	5'-3 3/32" (1602)	6046	5'-3 7/8" (1623)	6646	5'-4 11/16" (1643)	7046	5'-5 1/2" (1663)	7646	5'-6 9/32" (1684)	8046
5'-8 9/32" (1734)	5650	5'-9 3/32" (1755)	6050	5'-9 7/8" (1775)	6650	5'-10 11/16" (1795)	7050	5'-11 1/2" (1816)	7650	6'-0 9/32" (1836)	8050
6'-2 9/32" (1887)	5656	6'-3 3/32" (1907)	6056	6'-3 7/8" (1927)	6656	6'-4 11/16" (1948)	7056	6'-5 1/2" (1968)	7656	6'-6 9/32" (1989)	8056
6'-8 9/32" (2039)	5660	6'-9 3/32" (2059)	6060	6'-9 7/8" (2080)	6660	6'-10 11/16" (2100)	7060	6'-11 1/2" (2121)	7660	7'-0 9/32" (2141)	8060

100 Series
Picture, Transom &
Specialty Windows

PICTURE, TRANSOM & SPECIALTY WINDOWS

Arch Window Area Specifications

Window Number	Glass Area Sq. Ft./ (m ²)	Overall Window Area Sq. Ft./ (m ²)
2010	0.93 (0.09)	2.22 (0.21)
2016	1.65 (0.15)	3.20 (0.30)
2020	2.37 (0.22)	4.18 (0.39)
2026	3.09 (0.29)	5.16 (0.48)
2030	3.81 (0.35)	6.14 (0.57)
2036	4.52 (0.42)	7.12 (0.66)
2040	5.24 (0.49)	8.10 (0.75)
2046	5.96 (0.55)	9.08 (0.84)
2050	6.68 (0.62)	10.06 (0.93)
2056	7.40 (0.69)	11.04 (1.03)
2060	8.12 (0.75)	12.02 (1.12)
2610	1.34 (0.12)	2.90 (0.27)
2616	2.31 (0.21)	4.13 (0.38)
2620	3.28 (0.30)	5.36 (0.50)
2626	4.25 (0.39)	6.59 (0.61)
2630	5.22 (0.48)	7.82 (0.73)
2636	6.19 (0.57)	9.05 (0.84)
2640	7.16 (0.66)	10.28 (0.95)
2646	8.12 (0.75)	11.51 (1.07)
2650	9.09 (0.84)	12.74 (1.18)
2656	10.06 (0.93)	13.97 (1.30)
2660	11.03 (1.02)	15.20 (1.41)
3010	1.80 (0.17)	3.63 (0.34)
3016	3.02 (0.28)	5.11 (0.47)
3020	4.24 (0.39)	6.59 (0.61)
3026	5.46 (0.51)	8.07 (0.75)
3030	6.68 (0.62)	9.54 (0.89)
3036	7.90 (0.73)	11.02 (1.02)
3040	9.11 (0.85)	12.50 (1.16)
3046	10.33 (0.96)	13.98 (1.30)
3050	11.55 (1.07)	15.46 (1.44)
3056	12.77 (1.19)	16.94 (1.57)
3060	13.99 (1.30)	18.42 (1.71)
3610	2.30 (0.21)	4.40 (0.41)
3616	3.77 (0.35)	6.13 (0.57)
3620	5.24 (0.49)	7.86 (0.73)
3626	6.71 (0.62)	9.59 (0.89)
3630	8.18 (0.76)	11.31 (1.05)
3636	9.65 (0.90)	13.04 (1.21)
3640	11.12 (1.03)	14.77 (1.37)
3646	12.59 (1.17)	16.50 (1.53)
3650	14.05 (1.31)	18.23 (1.69)
3656	15.52 (1.44)	19.96 (1.85)
3660	16.99 (1.58)	21.69 (2.02)
4010	2.85 (0.27)	5.21 (0.48)
4016	4.57 (0.42)	7.19 (0.67)
4020	6.29 (0.58)	9.17 (0.85)
4026	8.01 (0.74)	11.15 (1.04)
4030	9.73 (0.90)	13.13 (1.22)
4036	11.45 (1.06)	15.11 (1.40)
4040	13.17 (1.22)	17.09 (1.59)
4046	14.88 (1.38)	19.07 (1.77)
4050	16.60 (1.54)	21.05 (1.96)
4056	18.32 (1.70)	23.03 (2.14)
4060	20.04 (1.86)	25.00 (2.32)
4610	3.45 (0.32)	6.07 (0.56)
4616	5.42 (0.50)	8.30 (0.77)
4620	7.38 (0.69)	10.53 (0.98)
4626	9.35 (0.87)	12.76 (1.19)
4630	11.32 (1.05)	14.99 (1.39)
4636	13.29 (1.23)	17.22 (1.60)

Window Number	Glass Area Sq. Ft./ (m ²)	Overall Window Area Sq. Ft./ (m ²)
4640	15.26 (1.42)	19.45 (1.81)
4646	17.23 (1.60)	21.68 (2.01)
4650	19.20 (1.78)	23.91 (2.22)
4656	21.17 (1.97)	26.14 (2.43)
4660	23.13 (2.15)	28.36 (2.64)
5010	4.09 (0.38)	6.98 (0.65)
5016	6.30 (0.59)	9.46 (0.88)
5020	8.52 (0.79)	11.94 (1.11)
5026	10.74 (1.00)	14.42 (1.34)
5030	12.96 (1.20)	16.90 (1.57)
5036	15.18 (1.41)	19.37 (1.80)
5040	17.40 (1.62)	21.85 (2.03)
5046	19.62 (1.82)	24.33 (2.26)
5050	21.84 (2.03)	26.81 (2.49)
5056	24.05 (2.23)	29.29 (2.72)
5060	26.27 (2.44)	31.77 (2.95)
5610	4.77 (0.44)	7.93 (0.74)
5616	7.24 (0.67)	10.66 (0.99)
5620	9.71 (0.90)	13.39 (1.24)
5626	12.18 (1.13)	16.12 (1.50)
5630	14.65 (1.36)	18.85 (1.75)
5636	17.11 (1.59)	21.58 (2.00)
5640	19.58 (1.82)	24.30 (2.26)
5646	22.05 (2.05)	27.03 (2.51)
5650	24.52 (2.28)	29.76 (2.77)
5656	26.99 (2.51)	32.49 (3.02)
5660	29.46 (2.74)	35.22 (3.27)
6010	5.50 (0.51)	8.93 (0.83)
6016	8.22 (0.76)	11.91 (1.11)
6020	10.94 (1.02)	14.88 (1.38)
6026	13.66 (1.27)	17.86 (1.66)
6030	16.38 (1.52)	20.84 (1.94)
6036	19.09 (1.77)	23.82 (2.21)
6040	21.81 (2.03)	26.80 (2.49)
6046	24.53 (2.28)	29.78 (2.77)
6050	27.25 (2.53)	32.76 (3.04)
6056	29.97 (2.78)	35.74 (3.32)
6060	32.69 (3.04)	38.72 (3.60)
6610	6.27 (0.58)	9.97 (0.93)
6616	9.24 (0.86)	13.20 (1.23)
6620	12.21 (1.13)	16.43 (1.53)
6626	15.18 (1.41)	19.66 (1.83)
6630	18.15 (1.69)	22.88 (2.13)
6636	21.12 (1.96)	26.11 (2.43)
6640	24.09 (2.24)	29.34 (2.73)
6646	27.06 (2.51)	32.57 (3.03)
6650	30.02 (2.79)	35.80 (3.33)
6656	32.99 (3.07)	39.03 (3.63)
6660	35.96 (3.34)	42.26 (3.93)
7010	7.10 (0.66)	11.05 (1.03)
7016	10.31 (0.96)	14.53 (1.35)
7020	13.53 (1.26)	18.01 (1.67)
7026	16.75 (1.56)	21.49 (2.00)
7030	19.97 (1.86)	24.97 (2.32)
7036	23.19 (2.15)	28.45 (2.64)
7040	26.41 (2.45)	31.93 (2.97)
7046	29.63 (2.75)	35.41 (3.29)
7050	32.85 (3.05)	38.89 (3.61)
7056	36.06 (3.35)	42.37 (3.94)
7060	39.28 (3.65)	45.85 (4.26)
7610	7.96 (0.74)	12.19 (1.13)

Window Number	Glass Area Sq. Ft./ (m ²)	Overall Window Area Sq. Ft./ (m ²)
7616	11.43 (1.06)	15.92 (1.48)
7620	14.90 (1.38)	19.64 (1.83)
7626	18.37 (1.71)	23.37 (2.17)
7630	21.84 (2.03)	27.10 (2.52)
7636	25.30 (2.35)	30.83 (2.86)
7640	28.77 (2.67)	34.56 (3.21)
7646	32.24 (3.00)	38.29 (3.56)
7650	35.71 (3.32)	42.02 (3.90)
7656	39.18 (3.64)	45.75 (4.25)
7660	42.65 (3.96)	49.48 (4.60)
8010	8.87 (0.82)	13.36 (1.24)
8016	12.59 (1.17)	17.34 (1.61)
8020	16.31 (1.52)	21.32 (1.98)
8026	20.03 (1.86)	25.30 (2.35)
8030	23.75 (2.21)	29.28 (2.72)
8036	27.47 (2.55)	33.26 (3.09)
8040	31.18 (2.90)	37.24 (3.46)
8046	34.90 (3.24)	41.22 (3.83)
8050	38.62 (3.59)	45.20 (4.20)
8056	42.34 (3.93)	49.18 (4.57)
8060	46.06 (4.28)	53.16 (4.94)

• Dimensions in parentheses are in square meters.

For picture, transom, circle, half circle, quarter circle and Springline™ window specifications, see pages 68-71.

Picture, Single Transom and Specialty Window Details – New Construction

Scale 1 1/2" (38) = 1'-0" (305) – 1:8

1 3/8" flange setback

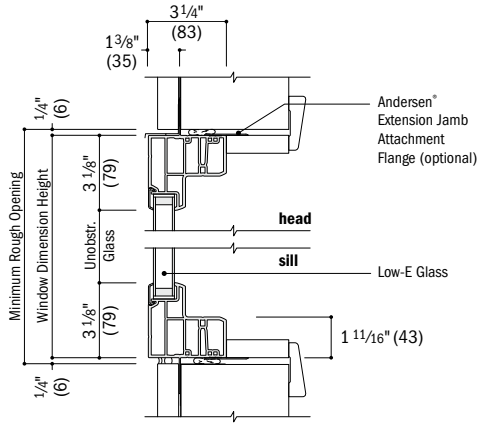

Vertical Section

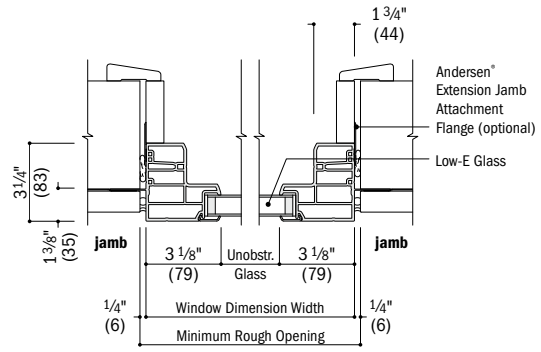

Horizontal Section

1" flange setback with stucco key

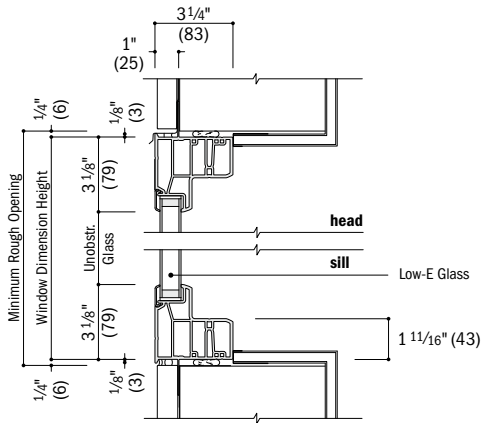

Vertical Section
stucco exterior

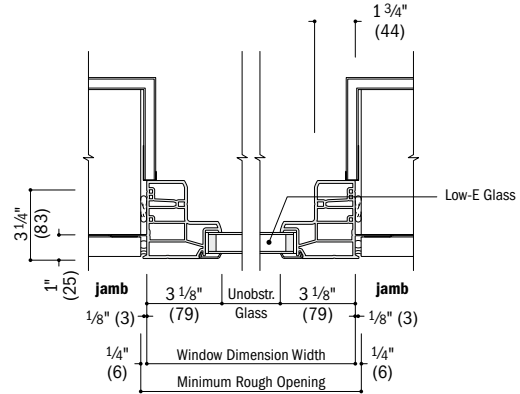

Horizontal Section
stucco exterior

- Drip cap is required to complete window installation as shown, but may not be included with the window. Use of drip cap is recommended for proper installation.
- Light-colored areas are parts included with window. Dark-colored areas are additional Andersen® parts required to complete window assembly as shown.
- **Rough openings may need to be increased to allow for use of building wraps, flashing, sill panning, brackets, fasteners or other items. See installation information on page 109.**
- Details are for illustration only and are not intended to represent product installation methods or materials. Refer to product installation guides at andersenwindows.com.
- Dimensions in parentheses are in millimeters.

PICTURE, TRANSOM & SPECIALTY WINDOWS

Twin and Triple Transom Window Details - New Construction

Scale 1 1/2" (38) = 1'-0" (305) - 1:8

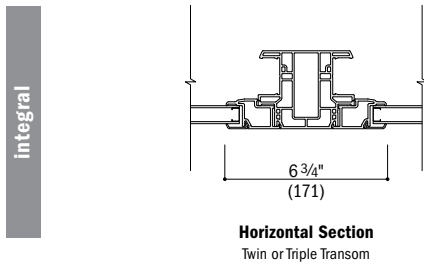
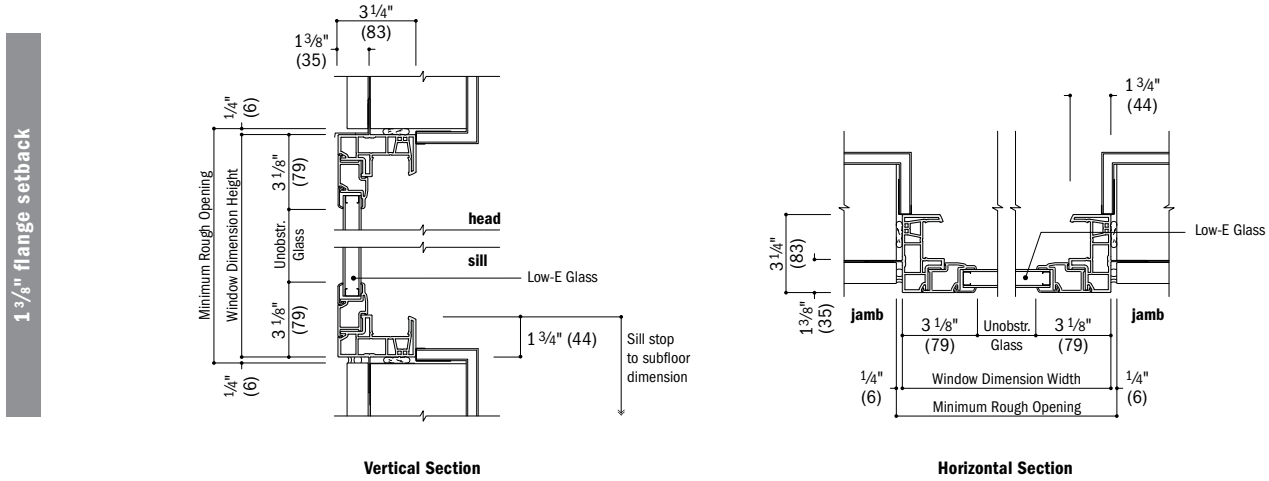

See pages 84-87 for horizontal and vertical joining details.

- Drip cap is required to complete window installation as shown, but may not be included with the window. Use of drip cap is recommended for proper installation.
- Light-colored areas are parts included with window. Dark-colored areas are additional Andersen® parts required to complete window assembly as shown.
- **Rough openings may need to be increased to allow for use of building wraps, flashing, sill panning, brackets, fasteners or other items. See installation information on page 109.**
- Details are for illustration only and are not intended to represent product installation methods or materials. Refer to product installation guides at andersenwindows.com.
- Dimensions in parentheses are in millimeters.

Picture, Single Transom and Specialty Window Details - Replacement

Scale 1 1/2" (38) = 1'-0" (305) - 1:8

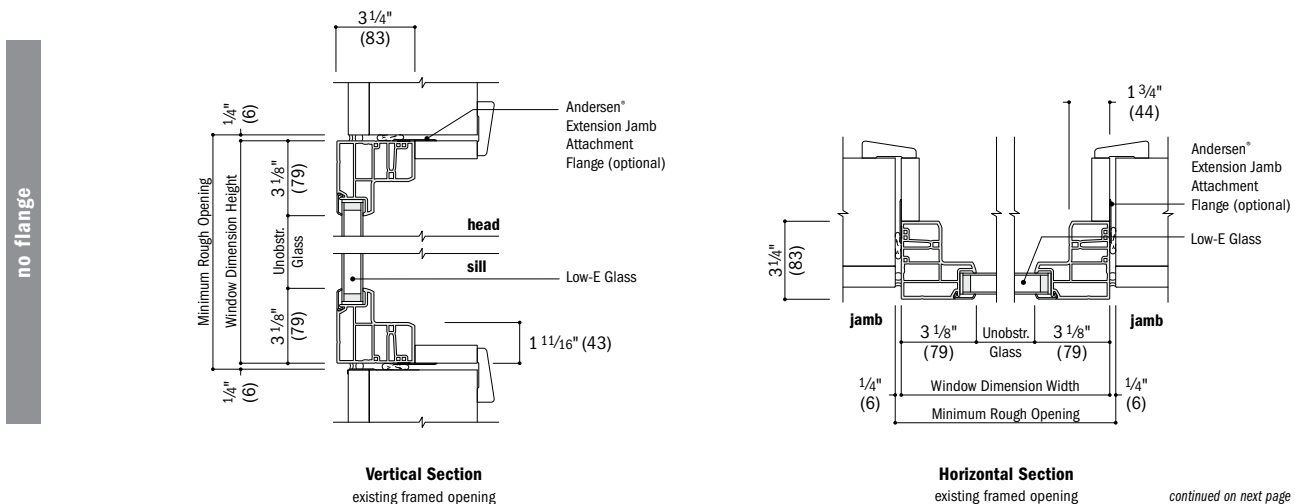

continued on next page

Picture, Single Transom and Specialty Window Details – Replacement *(continued)*

Scale 1 1/2" (38) = 1'-0" (305) – 1:8

insert

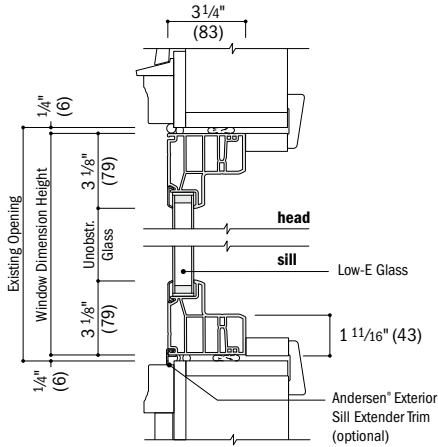

Vertical Section
existing window opening

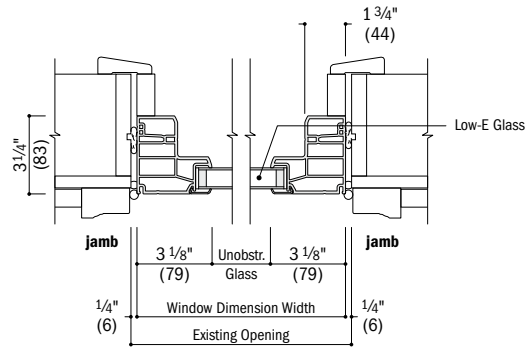

Horizontal Section
existing window opening

Twin and Triple Transom Window Details – Replacement

Scale 1 1/2" (38) = 1'-0" (305) – 1:8

insert

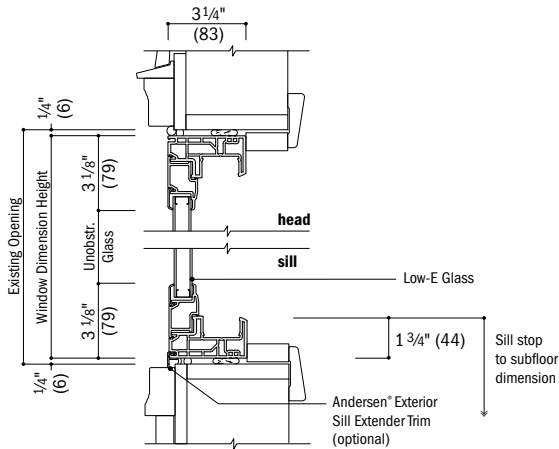

Vertical Section
existing window opening

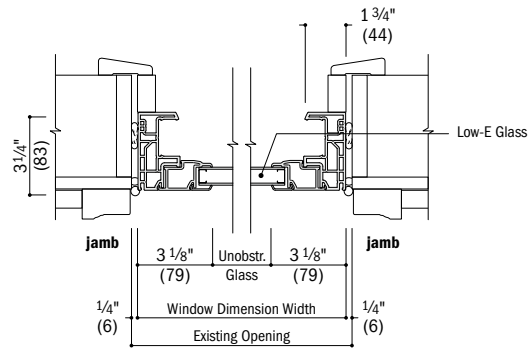

Horizontal Section
existing window opening

integral

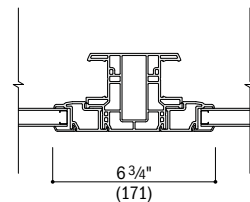

Horizontal Section
Twin or Triple Transom

Installation accessories for insert frame shown on page 108.

See pages 84-87 for horizontal and vertical joining details.

- Drip cap is required to complete window installation as shown, but may not be included with the window. Use of drip cap is recommended for proper installation.
- Light-colored areas are parts included with window. Dark-colored areas are additional Andersen® parts required to complete window assembly as shown.
- **Rough openings may need to be increased to allow for use of building wraps, flashing, sill panning, brackets, fasteners or other items. See installation information on page 109.**
- Details are for illustration only and are not intended to represent product installation methods or materials. Refer to product installation guides at andersenwindows.com.
- Dimensions in parentheses are in millimeters.

100 Series
Picture, Transom &
Specialty Windows

WINDOWS

Vertical (ribbon) Fiberglass Joining Details – Non-Reinforced

Scale 1 1/2" (38) = 1'-0" (305) – 1:8

Overall Window Dimension Width Sum of individual window widths plus 1/2" (13) per join.

Overall Minimum Rough Opening Width Overall window dimension width plus 3/4" (19).

The addition of joining materials will affect the overall rough opening dimension. See page 109.

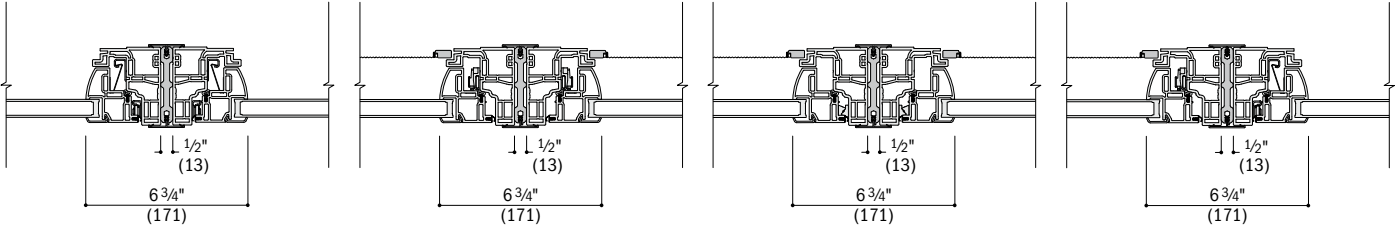

Casement to Casement
(stationary jamb to stationary jamb)

Casement to Casement
(lock jamb to lock jamb)

Casement to Casement
(hinge jamb to hinge jamb)

Casement to Casement
(lock jamb to stationary jamb)

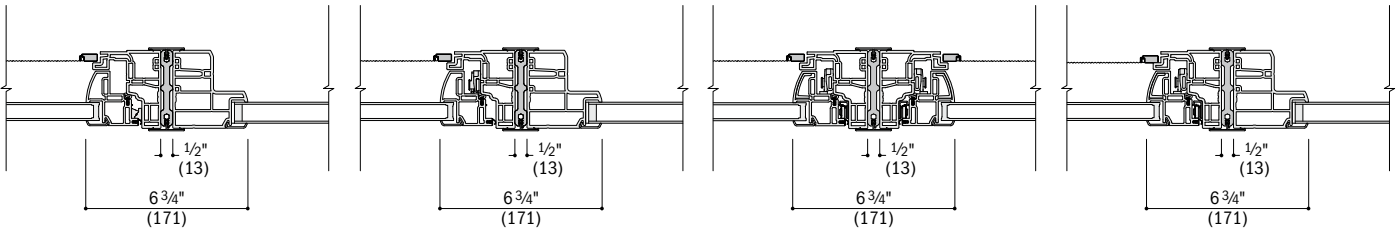

Casement to Picture/Single Transom
(casement hinge jamb)

Casement to Picture/Single Transom
(casement lock jamb)

Awning to Awning

Awning to Picture/Single Transom

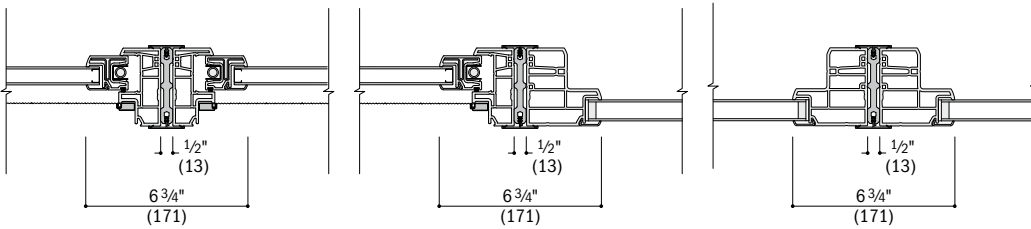

Single-Hung to Single-Hung

Single-Hung to Picture/Single Transom

**Picture/Single Transom to
Picture/Single Transom**

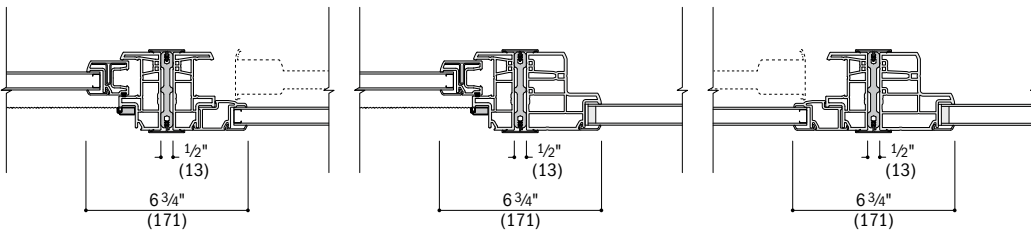

Gliding to Gliding
(active jamb to stationary jamb)

Gliding to Picture/Single Transom
(gliding active jamb)

Gliding to Picture/Single Transom
(gliding stationary jamb)

- Rough openings may need to be increased to allow for use of building wraps, flashing, sill panning, brackets, fasteners or other items. See installation information on page 109.
- Details are for illustration only and are not intended to represent product installation methods or materials. Refer to product installation guides at andersenwindows.com.
- Structural performance of any combination is only as high as the lowest structural performance of any individual window or join in the combination.
- Dimensions in parentheses are in millimeters.

Horizontal (stack) Fiberglass Joining Details – Non-Reinforced

Scale 1½" (38) = 1'-0" (305) – 1:8

Overall Window Dimension Width Sum of individual window widths plus ½" (13) per join.

Overall Minimum Rough Opening Width Overall window dimension width plus ¾" (19).

The addition of joining materials will affect the overall rough opening dimension. See page 109.

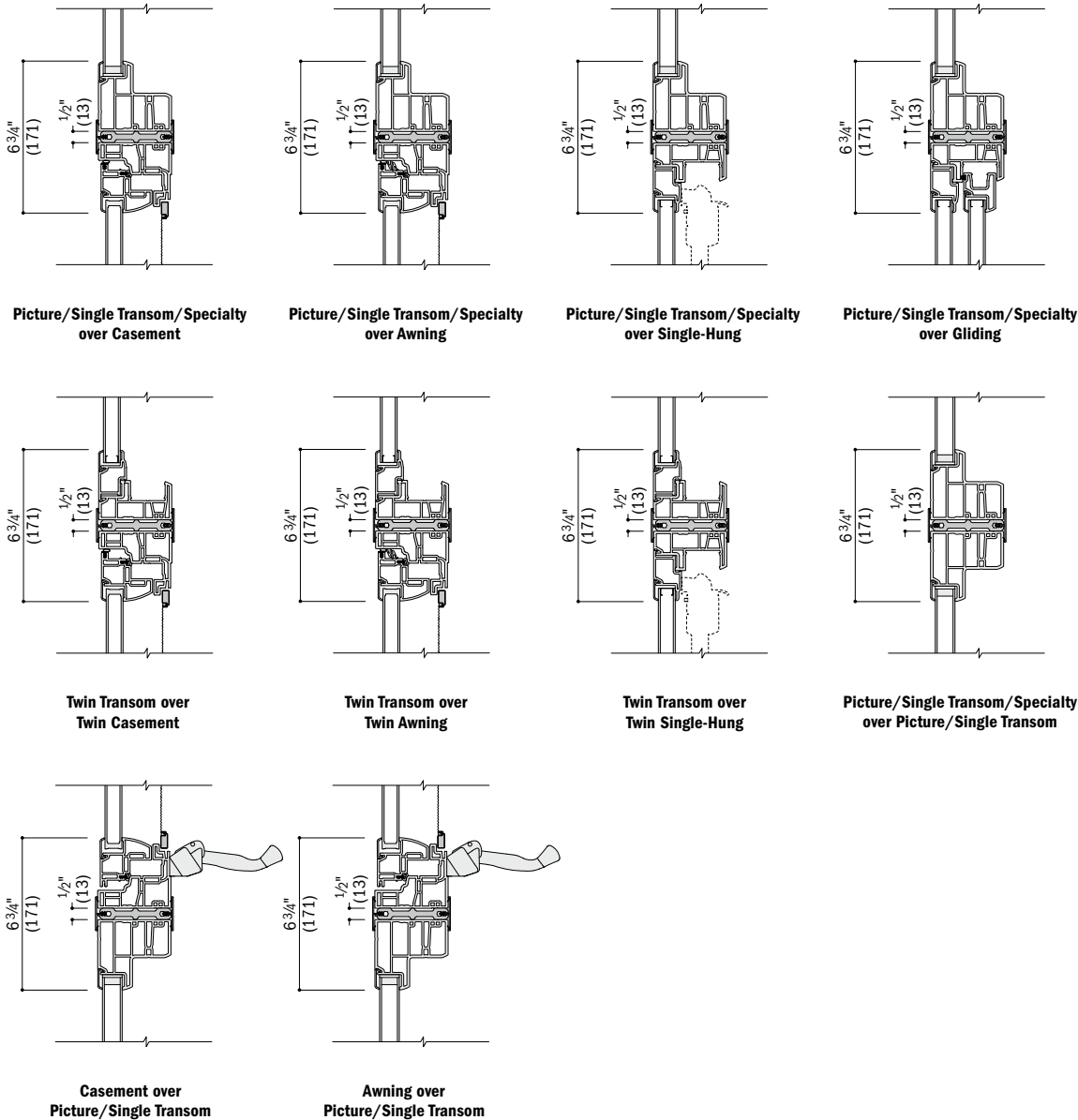

For more information on joining, refer to the combination designs section on page 99.

- Rough openings may need to be increased to allow for use of building wraps, flashing, sill panning, brackets, fasteners or other items. See installation information on page 109.
- Details are for illustration only and are not intended to represent product installation methods or materials. Refer to product installation guides at andersenwindows.com.
- Structural performance of any combination is only as high as the lowest structural performance of any individual window or join in the combination.
- Dimensions in parentheses are in millimeters.

WINDOWS

Vertical (ribbon) Fiberglass Joining Details – Reinforced

Scale 1 1/2" (38) = 1'-0" (305) – 1:8

Overall Window Dimension Width Sum of individual window widths plus 3/4" (19) per join.

Overall Minimum Rough Opening Width Overall window dimension width plus 3/4" (19).

The addition of joining materials will affect the overall rough opening dimension. See page 109.

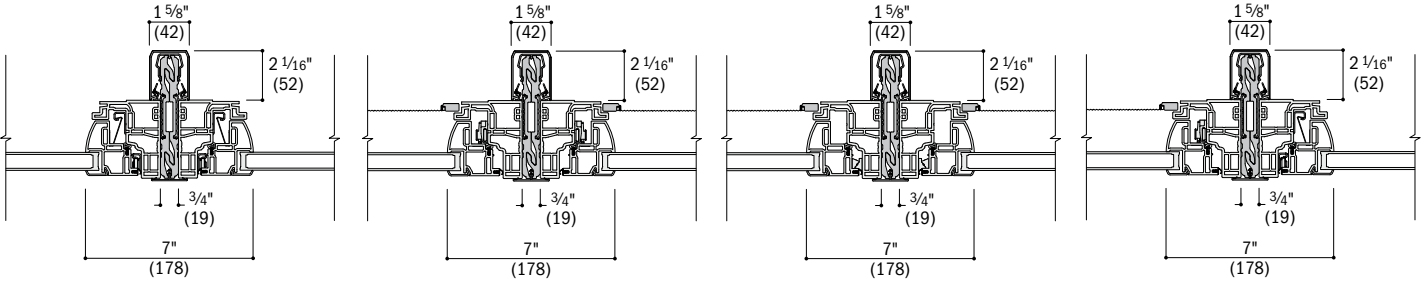

Casement to Casement
(stationary jamb to stationary jamb)

Casement to Casement
(lock jamb to lock jamb)

Casement to Casement
(hinge jamb to hinge jamb)

Casement to Casement
(lock jamb to stationary jamb)

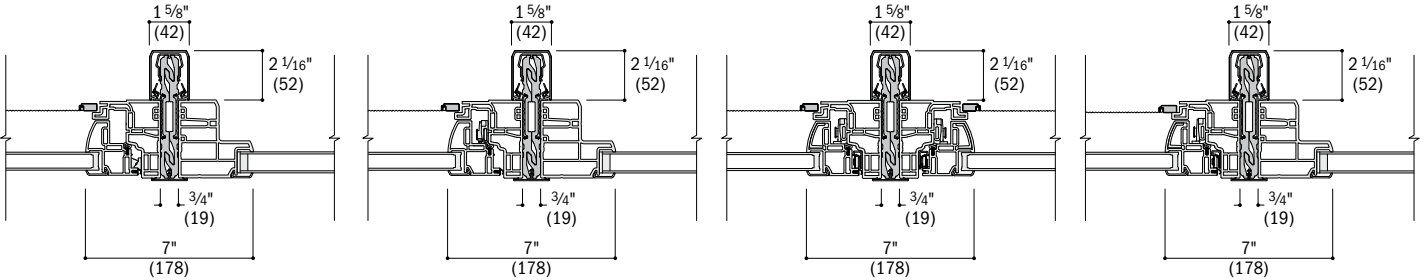

Casement to Picture/Single Transom
(casement hinge jamb)

Casement to Picture/Single Transom
(casement lock jamb)

Awning to Awning

Awning to Picture/Single Transom

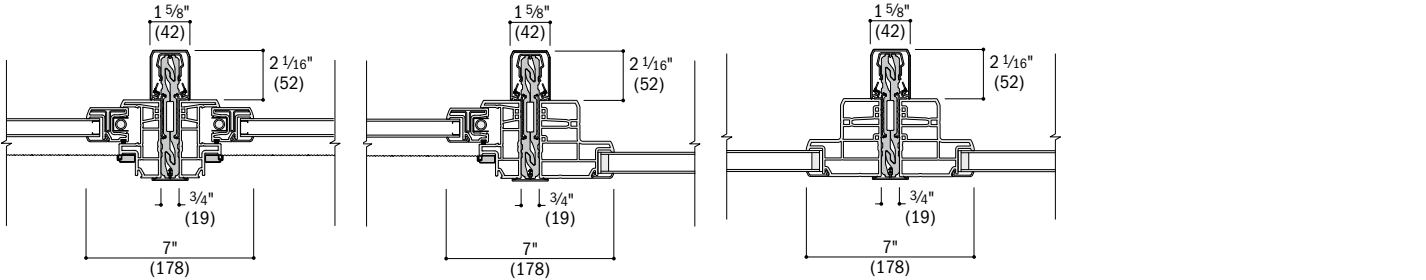

Single-Hung to Single-Hung

Single-Hung to Picture/Single Transom

Picture/Single Transom to Picture/Single Transom

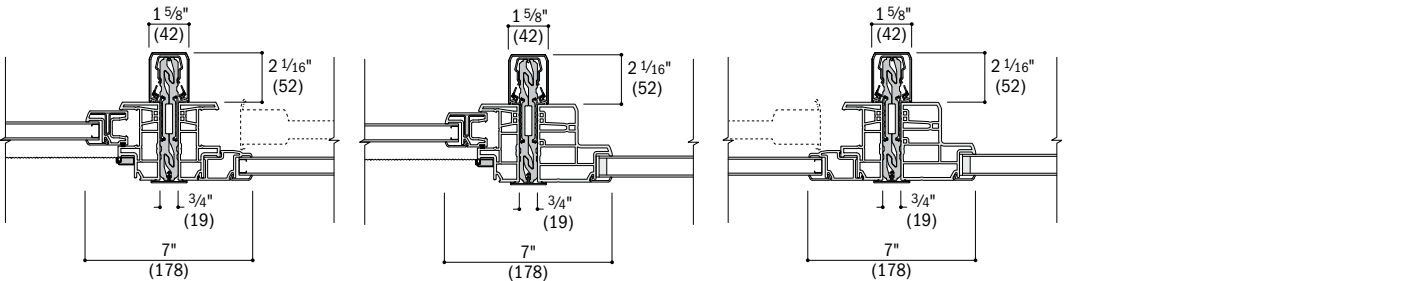

Gliding to Gliding
(active jamb to stationary jamb)

Gliding to Picture/Single Transom
(gliding active jamb)

Gliding to Picture/Single Transom
(gliding stationary jamb)

* Rough openings may need to be increased to allow for use of building wraps, flashing, sill panning, brackets, fasteners or other items. See installation information on page 109.

* Details are for illustration only and are not intended to represent product installation methods or materials. Refer to product installation guides at andersenwindows.com.

* Structural performance of any combination is only as high as the lowest structural performance of any individual window or join in the combination.

* Dimensions in parentheses are in millimeters.

Horizontal (stack) Fiberglass Joining Details – Reinforced

Scale 1½" (38) = 1'-0" (305) – 1:8

Overall Window Dimension Width Sum of individual window widths plus ¾" (19) per join.

Overall Minimum Rough Opening Width Overall window dimension width plus ¾" (19).

The addition of joining materials will affect the overall rough opening dimension. See page 109.

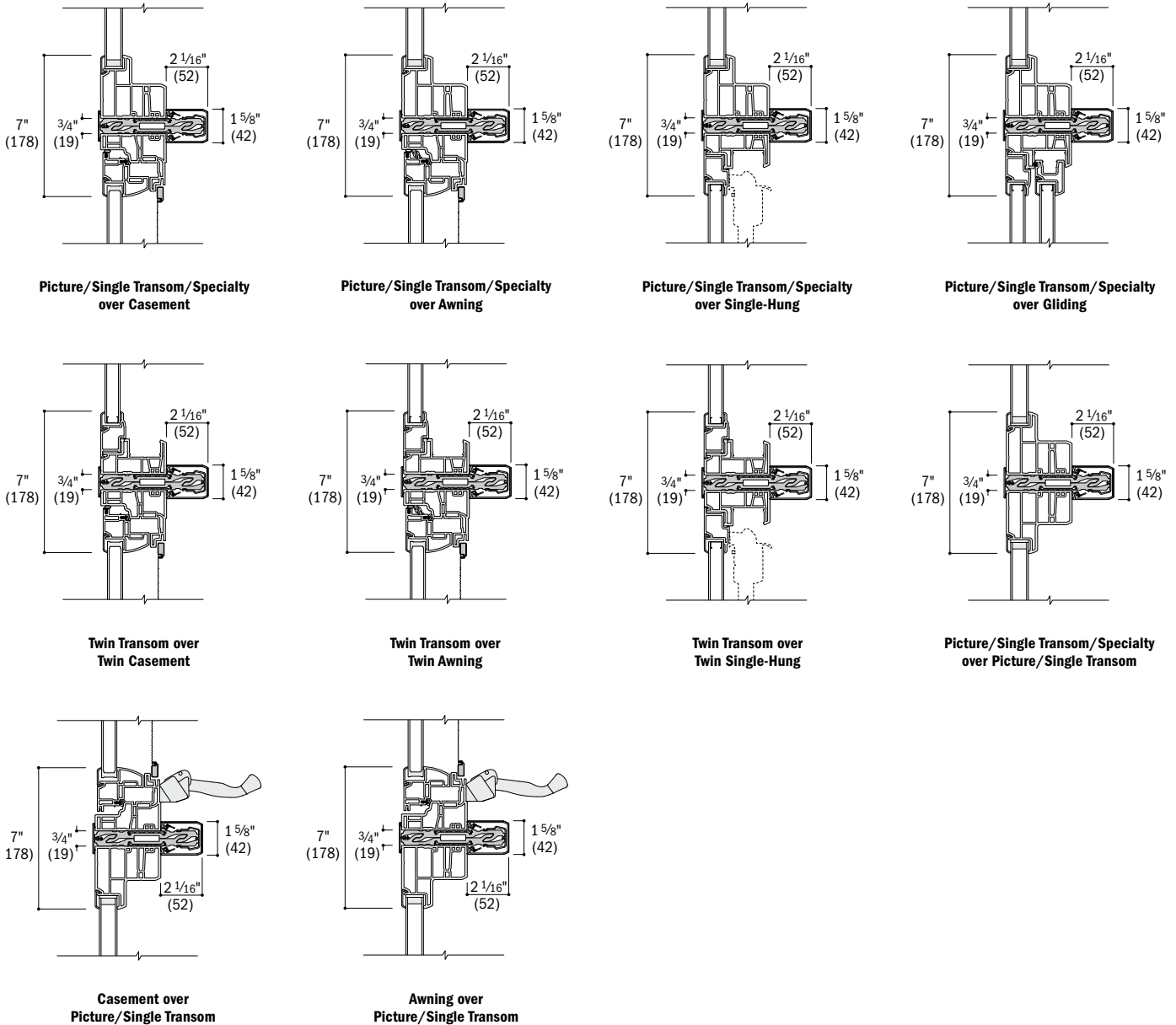

For more information on joining, refer to the combination designs section on page 99.

- Rough openings may need to be increased to allow for use of building wraps, flashing, sill panning, brackets, fasteners or other items. See installation information on page 109.
- Details are for illustration only and are not intended to represent product installation methods or materials. Refer to product installation guides at andersenwindows.com.
- Structural performance of any combination is only as high as the lowest structural performance of any individual window or join in the combination.
- Dimensions in parentheses are in millimeters.

WINDOWS

Custom Sizes & Specifications





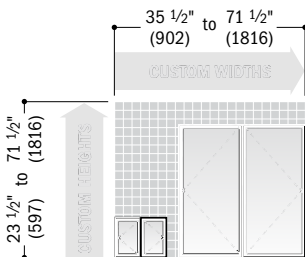
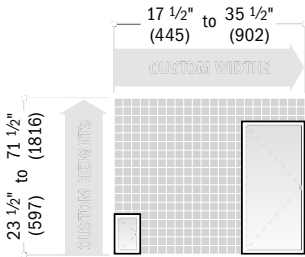

100 Series custom-size windows are available in 1/8" (3) increments between minimum and maximum widths and heights shown. Some restrictions apply.





Casement Windows



Single

Clear Opening 	Width = window width - 12.103" (307) <i>wash mode*</i> Width = window width - 7.790" (198) <i>widest clear opening*</i> Height = window height - 5.694" (145)	Minimum R.O. 	Width = window width + 1/2" (13) Height = window height + 1/2" (13)
Vent Opening 	Width = window width - 7.964" (202) Height = window height - 5.694" (145)	Unobstr. Glass 	Width = window width - 6.250" (159) Height = window height - 6.250" (159)

Twin

Clear Opening 	Width = (window width ÷ 2) - 12.353" (314) <i>wash mode*</i> Width = (window width ÷ 2) - 8.040" (204) <i>widest clear opening*</i> Height = window height - 5.694" (145)	Minimum R.O. 	Width = window width + 1/2" (13) Height = window height + 1/2" (13)
Vent Opening 	Width = window width - 16.428" (417) Height = window height - 5.694" (145)	Unobstr. Glass 	Single Sash Width = (window width ÷ 2) - 6.50" (165) Total Sash Width = window width - 13.000" (330) Height = window height - 6.250" (159)

*Widest clear opening hinge will be applied, based on window size, if it allows the window to meet or exceed clear opening area of 5.7 sq.ft. or 0.53 m², clear opening width of 20" (508) and clear opening height of 24" (610). Hinge type cannot be specified.

Awning Windows

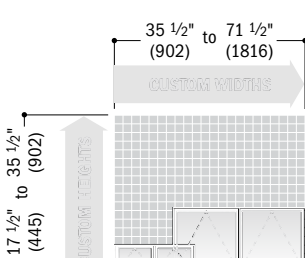
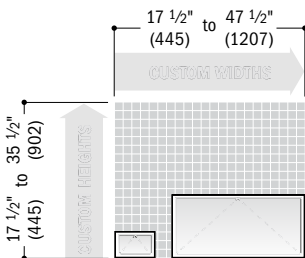





Single

Clear Opening 	Width = window width - 5.694" (145) Depth = 8.000" (203)	Minimum R.O. 	Width = window width + 1/2" (13) Height = window height + 1/2" (13)
Vent Opening 	Width = window width - 5.694" (145) Depth = 8.000" (203)	Unobstr. Glass 	Width = window width - 6.250" (159) Height = window height - 6.250" (159)

* Awning windows do not meet clear opening area of 5.7 sq.ft. or 0.53 m², clear opening width of 20" (508) and clear opening height of 24" (610).

Twin

Clear Opening 	Width = (window width ÷ 2) - 5.944" (151) Depth = 8.000" (203)	Minimum R.O. 	Width = window width + 1/2" (13) Height = window height + 1/2" (13)
Vent Opening 	Width = (window width ÷ 2) - 5.944" (151) Depth = 8.000" (203)	Unobstr. Glass 	Single Sash Width = (window width ÷ 2) - 6.50" (165) Total Sash Width = window width - 13.000" (330) Height = window height - 6.250" (159)

* Awning windows do not meet clear opening area of 5.7 sq.ft. or 0.53 m², clear opening width of 20" (508) and clear opening height of 24" (610).

* Dimensions in parentheses are in millimeters.

* **Clear Opening** formulas provide dimensions for determining area available for egress. **Vent Opening** formulas provide dimensions for determining area available for passage of air. **Minimum R.O.** (minimum rough opening) formulas provide minimum rough opening width and height dimensions. **Unobstr. Glass** (unobstructed glass) formulas provide dimensions for determining area available for passage of light.

Awning Windows (continued)

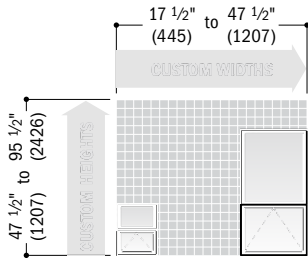

Contact your Andersen supplier for min/max height dimensions for lower venting sash.

Picture Window over Awning

	Clear Opening	Width = window width - 5.694" (145) Depth = 8.000" (203)		Minimum R.O.	Width = window width + 1/2" (13) Height = window height + 1/2" (13)
		Vent Opening		Width = window width - 5.694" (145) Depth = 8.000" (203)	

* Awning windows do not meet clear opening area of 5.7 sq.ft. or 0.53 m², clear opening width of 20" (508) and clear opening height of 24" (610).

Single-Hung Windows

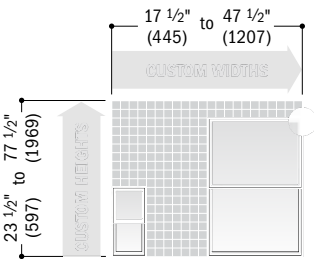

Windows with a height greater than 77 1/2" (1969) are only available with a 2:1 reverse cottage sash ratio.*

Equal Sash Ratio

	Clear Opening	Width = window width - 3.500" (89) Height = (window height + 2) - 3.711" (94)		Minimum R.O.	Width = window width + 1/2" (13) Height = window height + 1/2" (13)
		Vent Opening		Equal Sash Ratio Width = window width - 3.500" (89) Height = (window height + 2) - 3.711" (94)	

* Drywall pass-through window is available for custom-size windows wider than 23 1/2" (597) and taller than 53 1/2" (1359).
* Windows with a 3:2 reverse cottage sash ratio are available in custom sizes from 17 1/2" (445) to 47 1/2" (1207) in width to 29 1/2" (749) to 77 1/2" (1969) in height. For area and opening specification formulas, visit andersenwindows.com.
* Window heights that require a 2:1 reverse cottage sash ratio are available in custom sizes from 17 1/2" (445) to 47 1/2" (1207) in width to 77 5/8" (1972) to 89 1/2" (2273) in height. For area and opening specifications, contact your Andersen supplier.

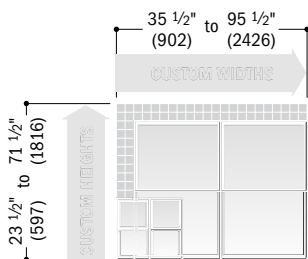

Twin

	Clear Opening	Width = (window width + 2) - 3.750" (95) Height = (window height + 2) - 3.711" (94)		Minimum R.O.	Width = window width + 1/2" (13) Height = window height + 1/2" (13)
		Vent Opening		Equal Sash Ratio Width = window width - 3.500" (89) Height = (window height + 2) - 3.711" (94)	

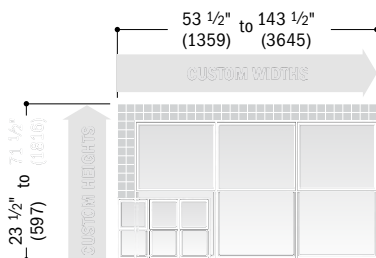

Triple

	Clear Opening	Width = (window width + 3) - 3.833" (97) Height = (window height + 2) - 3.711" (94)		Minimum R.O.	Width = window width + 1/2" (13) Height = window height + 1/2" (13)
		Vent Opening		Equal Sash Ratio Width = window width - 11.500" (292) Height = (window height + 2) - 3.711" (94)	

* Dimensions in parentheses are in millimeters.
* **Clear Opening** formulas provide dimensions for determining area available for egress. **Vent Opening** formulas provide dimensions for determining area available for passage of air. **Minimum R.O.** (minimum rough opening) formulas provide minimum rough opening width and height dimensions. **Unobstr. Glass** (unobstructed glass) formulas provide dimensions for determining area available for passage of light.

WINDOWS

Gliding Windows

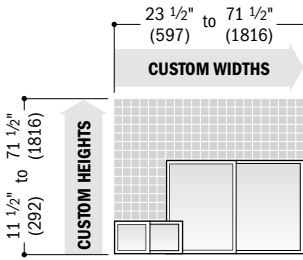

Active-Stationary or Stationary-Active (X0/OX)

Clear Opening	Width = (window width ÷ 2) - 3.711" (94) Height = window height - 3.500" (89)	Minimum R.O.	Width = window width + 1/2" (13) Height = window height + 1/2" (13)
Vent Opening	Width = (window width ÷ 2) - 3.711" (94) Height = window height - 3.500" (89)	Unobstr. Glass	Fixed Sash Width = (window width ÷ 2) - 4.184" (106) Venting Sash Width = (window width ÷ 2) - 4.226" (107) Total Sash Width = window width - 8.410" (214) Height = window height - 6.250" (159)

Active-Stationary-Active (XOX) 1:2:1 Sash Ratio

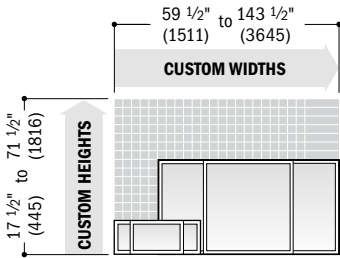

Clear Opening	Width = (window width ÷ 4) - 2.976" (76) Height = window height - 3.500" (89)	Minimum R.O.	Width = window width + 1/2" (13) Height = window height + 1/2" (13)
Vent Opening	Width = (window width ÷ 2) - 5.952" (151) Height = window height - 3.500" (89)	Unobstr. Glass	Fixed Sash Width = (window width ÷ 2) - 1.868" (47) Venting Sash Width = (window width ÷ 4) - 4.351" (111) Total Sash Width = window width - 10.570" (268) Height = window height - 6.250" (159)

Active-Stationary-Active (XOX) 1:1:1 Equal Sash Ratio

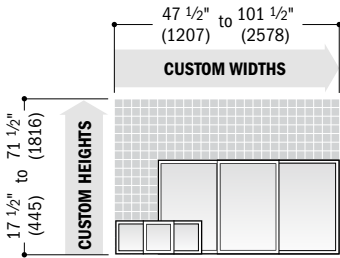

Clear Opening	Width = (window width ÷ 3) - 5.164" (131) Height = window height - 3.500" (89)	Minimum R.O.	Width = window width + 1/2" (13) Height = window height + 1/2" (13)
Vent Opening	Width = (window width x 2) ÷ 3 - 10.328" (262) Height = window height - 3.500" (89)	Unobstr. Glass	Fixed Sash Width = (window width ÷ 3) - 3.496" (89) Venting Sash Width = (window width ÷ 3) - 3.537" (90) Total Sash Width = window width - 10.570" (268) Height = window height - 6.250" (159)

Picture and Transom Windows

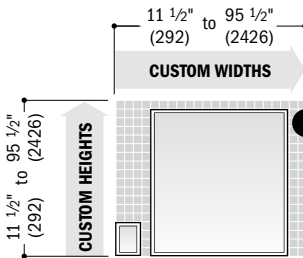

! Either height or width must be 71 1/2" (1816) or less.

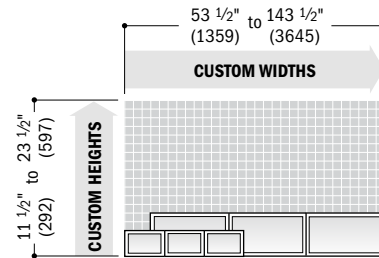
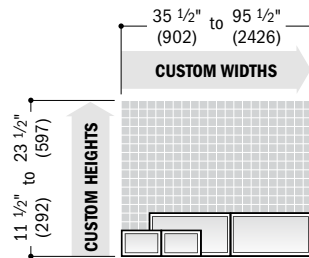

Triple transom windows with unequal sashes are not available in custom sizes.

Picture and Single Transom

Minimum R.O.	Width = window width + 1/2" (13) Height = window height + 1/2" (13)
Unobstr. Glass	Width = window width - 6.250" (159) Height = window height - 6.250" (159)

Twin and Triple Transom

Minimum R.O.	Twin Width = window width + 1/2" (13) Height = window height + 1/2" (13)	Triple Width = window width + 1/2" (13) Height = window height + 1/2" (13)
Unobstr. Glass	Twin Single Sash Width = (window width ÷ 2) - 6.500" (165) Total Sash Width = window width - 13.000" (330) Height = window height - 6.250" (159)	Triple Single Sash Width = (window width ÷ 3) - 6.583" (167) Total Sash Width = window width - 19.750" (502) Height = window height - 6.250" (159)

* Dimensions in parentheses are in millimeters.

* **Clear Opening** formulas provide dimensions for determining area available for egress. **Vent Opening** formulas provide dimensions for determining area available for passage of air. **Minimum R.O.** (minimum rough opening) formulas provide minimum rough opening width and height dimensions. **Unobstr. Glass** (unobstructed glass) formulas provide dimensions for determining area available for passage of light.

PATIO DOORS

SECTION REFERENCE

Gliding Patio Doors

Table of Sizes.....	93
Specifications.....	93
Grille Patterns.....	94
Door Details.....	94

Patio Door Sidelights & Transoms

Table of Sizes.....	95
Specifications.....	95
Grille Patterns.....	94
Sidelight & Transom Details.....	96
Joining Details.....	97
Custom Sizing.....	98
Combination Designs.....	99
Product Performance.....	102

CUSTOM SIZING

in 1/8" (3) increments



Dimensions in parentheses are in millimeters.

PATIO DOORS

FEATURES

GLIDING PATIO DOORS

Frame

A Frame constructed with Fibrex® composite material. This construction produces a rigid frame.

B Durable, low-maintenance finish won't fade, flake, blister or peel.

Factory-assembled doors arrive at the jobsite ready to install.

C Dual-felt weatherstrip, applied on the inside pocket of both side jambs and the head jamb, creates a positive seal between the frame and panels. The result is a long-lasting, energy-efficient barrier against wind, water and dust.

A full-length combination weatherstrip/interlock system provides a flexible seal at the meeting stile.

Three frame options include:

- 1 3/8" (35) flange setback for siding applications. An integral rigid vinyl flange helps seal the unit to the structure.
- 1" (25) flange setback with stucco key. An integral rigid vinyl flange helps seal the unit to the structure.
- No-flange option for door replacement in an existing framed opening.

Sill

D One-piece sill design with weep holes located on the sill exterior provides superior water management. The heavy gauge PVC construction is wear-resistant and neutral gray in color.

E The roller track has a stainless steel cap that resists denting for smooth, reliable operation.

Panel

F Fibrex material construction provides long-lasting performance*. The panel, finished with a durable capping, provides maximum protection and a matte, low-maintenance finish.

G Dual corrosion-resistant* ball-bearing rollers on the operating door panel provide smooth operation with self-contained leveling adjusters. The rollers have deep grooves to increase engagement with the roller track and resist lateral movement. Metal reinforcement inserted into the panel stiles provides additional stability.



Glass

A glazing bead and silicone provides superior weathertightness and durability.

H High-Performance glass options include:

- Low-E SmartSun™ tempered glass
- Low-E SmartSun HeatLock® tempered glass
- Low-E tempered glass
- Low-E HeatLock tempered glass
- Low-E Sun™ tempered glass
- Dual-pane tempered glass

Additional glass options are available. Contact your Andersen supplier.

A removable translucent film helps shield the glass from damage during delivery and construction and simplifies finishing at the jobsite.

Patterned Glass

Patterned glass options are available. See page 12 for more details.

Hardware

Locking System



A two-point locking system engages a steel receiver plate that is secured into the side jamb. This provides enhanced security and a weathertight seal, with the operating panel pulled tightly into the jamb.

Tulsa and Afton hardware options are available. Tulsa hardware handles come in colors to match the exterior and interior colors of the door. Afton hardware has the same finish inside and out.

EXTERIOR



White Sandtone Terratone



Dark Bronze Black

INTERIOR



White Sandtone**



Dark Bronze** Black**

HARDWARE FINISHES

Tulsa hardware matches the exterior and interior color options shown above.

Afton hardware available in these finishes:



Antique Brass Black Bright Brass Satin Nickel

HARDWARE OPTIONS

Tulsa Hardware



Exterior Interior

Exterior handle matches exterior door color. Shown in dark bronze.

Interior handle matches interior door color. Shown in white.

Optional Afton Hardware



Exterior Interior

Antique Brass | Bright Brass
Black | **Satin Nickel**

Bold name denotes finish shown.

ACCESSORIES Sold Separately

Hardware

Auxiliary Foot Lock

Provides an extra measure of security when the door is in a locked position. Available in colors that coordinate with the interior.

Grilles

Grilles are available in a variety of configurations. See page 13 for details.

Insect Screens

Insect screens are available with a charcoal gray fiberglass screen mesh and the frames are color-matched to the door exterior. The latch mechanism is contained within the insect screen handle for easy operation.

Sidelights & Transoms

Patio door sidelights and transoms are available for patio doors. See pages 95-96.

* Visit andersenwindows.com/warranty for details.

** Products with dark bronze, black and Sandtone interiors have matching exteriors.

Printing limitations prevent exact replication of colors and finishes. See your Andersen supplier for actual color and finish samples.

Three Patio Door Heights

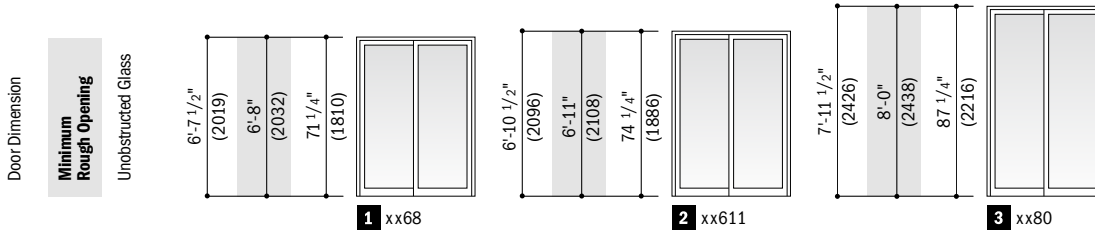

Table of Gliding Patio Doors Sizes

Scale 1/8" (3) = 1'-0" (305) – 1:96

Door Dimension	4'-11 1/4" (1505)	4'-11 1/4" (1505)	5'-11 1/4" (1810)	5'-11 1/4" (1810)
Minimum Rough Opening	5'-0" (1524)	5'-0" (1524)	6'-0" (1829)	6'-0" (1829)
Unobstructed Glass (width of single panel only)	24 1/8" (613)	24 1/8" (613)	30 1/8" (765)	30 1/8" (765)

Door Dimension	7'-11 1/4" (2419)	7'-11 1/4" (2419)
Minimum Rough Opening	8'-0" (2438)	8'-0" (2438)
Unobstructed Glass (width of single panel only)	42 1/8" (1070)	42 1/8" (1070)



Custom-size patio doors are available in 1/8" (3) increments. See page 98 for custom sizes and specifications.

Arrow indicates direction of panel operation as viewed from the exterior. Details and grille patterns shown on page 94.

To meet or exceed a clear opening width of 32" (813), select a door width that requires a rough opening width of 6'6" (1981) or greater.

Order Designation Description

Viewed from the exterior.

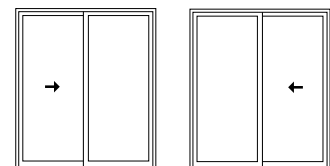

6068 L Door Rough Opening Left Gliding
6068 R Door Rough Opening Right Gliding

- "Door Dimension" always refers to outside frame to frame dimension.
- "Minimum Rough Opening" dimensions may need to be increased to allow for use of building wraps, flashing, sill panning, brackets, fasteners or other items. See page 109 for more details.
- Dimensions in parentheses are in millimeters.
- Meet or exceed a 32" (813) clear opening width.

Gliding Patio Door Opening and Area Specifications

Door Number	Clear Opening Area* Sq. Ft./ (m ²)	Clear Opening in Full Open Position		Glass Area Sq. Ft./ (m ²)	Vent Area* Sq. Ft./ (m ²)	Overall Door Area Sq. Ft./ (m ²)
		Width* Inches/(mm)	Height Inches/(mm)			
5068	12.38 (1.15)	23 1/2" (597)	75 7/8" (1927)	23.87 (2.22)	12.38 (1.15)	32.71 (3.04)
6068	15.54 (1.44)	29 1/2" (749)	75 7/8" (1927)	31.27 (2.91)	15.54 (1.44)	39.34 (3.65)
8068	21.87 (2.03)	41 1/2" (1054)	75 7/8" (1927)	43.14 (4.01)	21.87 (2.03)	52.59 (4.89)
50611	12.87 (1.20)	23 1/2" (597)	78 7/8" (2003)	52.79 (4.90)	12.87 (1.20)	33.95 (3.15)
60611	16.16 (1.50)	29 1/2" (749)	78 7/8" (2003)	32.58 (3.03)	16.16 (1.50)	40.82 (3.79)
80611	22.73 (2.11)	41 1/2" (1054)	78 7/8" (2003)	44.96 (4.18)	22.73 (2.11)	54.57 (5.07)
5080	14.99 (1.39)	23 1/2" (597)	91 7/8" (2334)	31.02 (2.88)	14.99 (1.39)	39.29 (3.65)
6080	18.82 (1.75)	29 1/2" (749)	91 7/8" (2334)	38.29 (3.56)	18.82 (1.75)	47.25 (4.39)
8080	26.48 (2.46)	41 1/2" (1054)	91 7/8" (2334)	52.83 (4.91)	26.48 (2.46)	63.17 (5.87)

- Dimensions in parentheses are in millimeters or square meters.
- For doors with Tulsa hardware only. Contact your Andersen supplier for doors with Afton hardware.

GLIDING PATIO DOORS

Grille Patterns

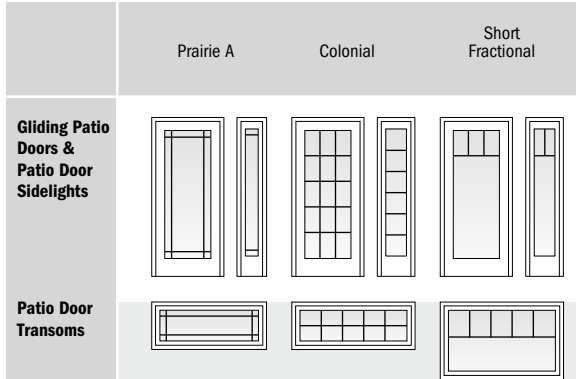

Number of lights and overall pattern varies with door size. Patterns shown may not be available for all sizes. Specified equal light pattern is also available. For more information on divided light, see page 13 or visit andersenwindows.com/grilles.

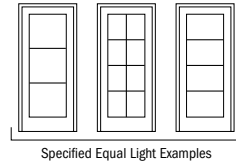

Gliding Patio Door Details

Scale 1 1/2" (38) = 1'-0" (305) – 1:8

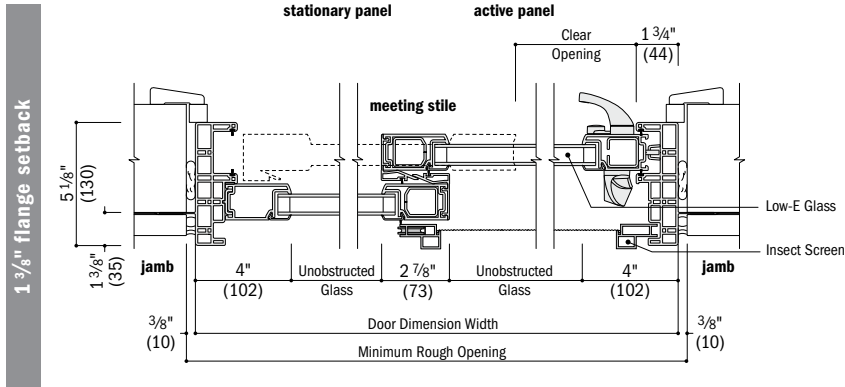

Horizontal Section

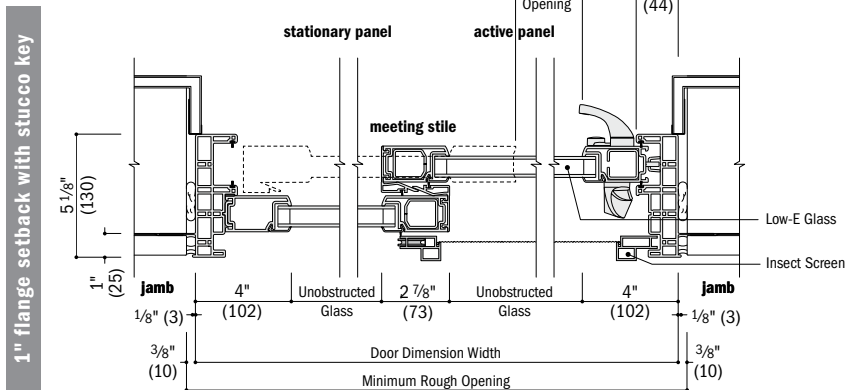

Horizontal Section
stucco exterior

See page 97 for horizontal and vertical joining details.

- Drip cap is required to complete door installation as shown, but may not be included with the door. Use of drip cap is recommended for proper installation.
- Rough openings may need to be increased to allow for use of building wraps, flashing, sill panning, brackets, fasteners or other items. See installation information on page 109.
- Details are for illustration only and are not intended to represent product installation methods or materials. Refer to product installation guides at andersenwindows.com.
- Dimensions in parentheses are in millimeters.

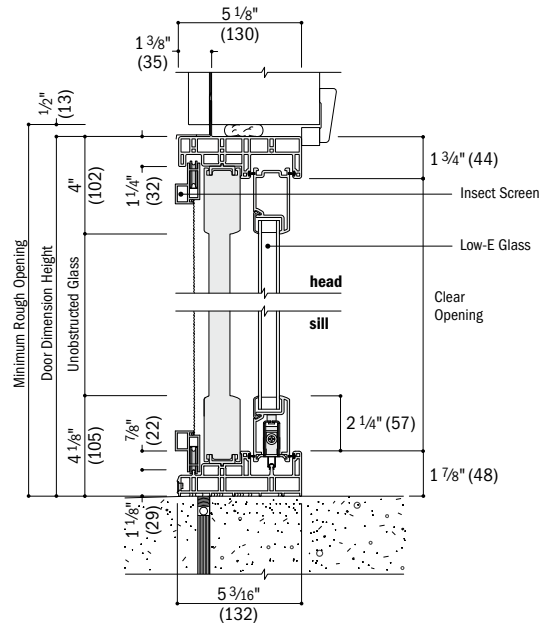

Vertical Section

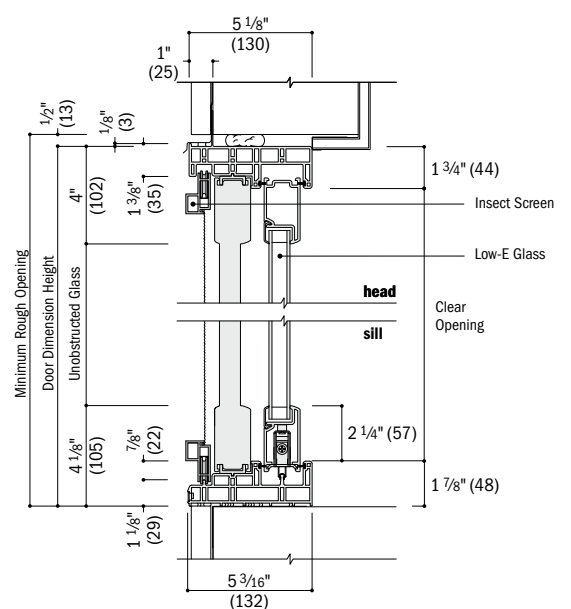

Vertical Section
stucco exterior

Table of Patio Door Transom and Sidelight Sizes

Scale 1/8" (3) = 1'-0" (305) – 1:96

Transom/Sidelight Dimension	1'-2 1/4" (362)	1'-5 1/4" (438)	1'-11 1/4" (591)	2'-5 1/4" (743)	2'-11 1/4" (895)	3'-11 1/4" (1200)	4'-11 1/4" (1505)	5'-11 1/4" (1810)	7'-11 1/4" (2419)
Minimum Rough Opening	1'-3" (381)	1'-6" (457)	2'-0" (610)	2'-6" (762)	3'-0" (914)	4'-0" (1219)	5'-0" (1524)	6'-0" (1829)	8'-0" (2438)
Unobstructed Glass	6 3/16" (157)	9 3/16" (233)	15 3/16" (386)	21 3/16" (538)	27 3/16" (691)	39 3/16" (995)	51 3/16" (1300)	63 3/16" (1605)	87 3/16" (2215)

CUSTOM WIDTHS – 14 1/4" to 95 1/4"

CUSTOM HEIGHTS – 14 1/4" to 23 1/4"	1'-2 1/4" (362)	1'-3" (381)	1'-5 1/4" (438)	1'-6" (457)	1'-11 1/4" (591)	2'-0" (610)	2'-5 1/4" (743)	2'-11 1/4" (895)	3'-11 1/4" (1200)	4'-11 1/4" (1505)	5'-11 1/4" (1810)	7'-11 1/4" (2419)
	1313	1613	2013	2613	3013	4013	5013	6013	8013			
	1316	1616	2016	2616	3016	4016	5016	6016	8016			
	1320	1620	2020	2620	3020	4020	5020	6020	8020			

CUSTOM WIDTHS – 14 1/4" to 47 1/4"

CUSTOM HEIGHTS – 79 1/2" to 95 1/2"	6'-7 1/2" (2019)	6'-8" (2032)	6'-11 1/2" (2096)	6'-11" (2108)	7'-1 1/4" (1810)	7'-11 1/2" (2426)	8'-0" (2438)	8'-1 1/4" (2216)
	1368	1668	2068	2668	3068	4068		
	13611	16611	20611	26611	30611	40611		
	1380	1680	2080	2680	3080	4080		



Custom-size doors are available in 1/8" (3) increments. See page 98 for custom sizes and specifications.

Details shown on page 96.
Grille patterns shown on page 94.

- "Transom/Sidelight Dimension" always refers to outside frame to frame dimension.
- "Minimum Rough Opening" dimensions may need to be increased to allow for use of building wraps, flashing, sill panning, brackets, fasteners or other items. See page 109 for more details.
- Dimensions in parentheses are in millimeters.

Patio Door Sidelight Area Specifications

Sidelight Number	Glass Area Sq. Ft./ (m ²)	Overall Window Area Sq. Ft./ (m ²)
1368	3.06 (0.28)	7.87 (0.73)
13611	3.19 (0.30)	8.16 (0.76)
1380	3.75 (0.35)	9.45 (0.88)
1668	4.55 (0.42)	9.52 (0.88)
16611	4.74 (0.44)	9.88 (0.92)
1680	5.57 (0.52)	11.44 (1.06)
2068	7.51 (0.70)	12.84 (1.19)
20611	7.83 (0.73)	13.32 (1.24)
2080	9.20 (0.85)	15.42 (1.43)
2668	10.48 (0.97)	16.15 (1.50)
26611	10.92 (1.01)	16.76 (1.56)
2680	12.84 (1.19)	19.40 (1.80)
3068	13.45 (1.25)	19.46 (1.81)
30611	14.02 (1.30)	20.20 (1.88)
3080	16.47 (1.53)	23.38 (2.17)
4068	19.39 (1.80)	26.09 (2.42)
40611	20.21 (1.88)	27.07 (2.51)
4080	23.74 (2.21)	31.34 (2.91)

Patio Door Transom Area Specifications

Transom Number	Glass Area Sq. Ft./ (m ²)	Overall Window Area Sq. Ft./ (m ²)
1313	0.27 (0.03)	1.41 (0.13)
1316	0.40 (0.04)	1.71 (0.16)
1320	0.65 (0.06)	2.30 (0.21)
1613	0.40 (0.04)	1.71 (0.16)
1616	0.59 (0.05)	2.07 (0.19)
1620	0.97 (0.09)	2.79 (0.26)
2013	0.65 (0.06)	2.30 (0.21)
2016	0.97 (0.09)	2.79 (0.26)
2020	1.61 (0.15)	3.75 (0.35)
2613	0.91 (0.09)	2.90 (0.27)
2616	1.35 (0.13)	3.50 (0.33)
2620	2.24 (0.21)	4.72 (0.44)
3013	1.17 (0.11)	3.49 (0.32)
3016	1.74 (0.16)	4.22 (0.39)
3020	2.87 (0.27)	5.69 (0.53)
4013	1.69 (0.16)	4.68 (0.43)
4016	2.50 (0.23)	5.66 (0.53)
4020	4.13 (0.39)	7.63 (0.71)

Transom Number	Glass Area Sq. Ft./ (m ²)	Overall Window Area Sq. Ft./ (m ²)
5013	2.20 (0.20)	5.86 (0.55)
5016	3.27 (0.30)	7.10 (0.66)
5020	5.40 (0.50)	9.57 (0.89)
6013	2.72 (0.25)	7.05 (0.66)
6016	4.03 (0.38)	8.54 (0.79)
6020	6.67 (0.62)	11.50 (1.07)
8013	3.75 (0.35)	9.43 (0.88)
8016	5.56 (0.52)	11.41 (1.06)
8020	9.20 (0.85)	15.38 (1.43)

• Dimensions in parentheses are in square meters.

PATIO DOOR SIDELIGHTS & TRANSOMS

Patio Door Sidelight and Transom Details

Scale 1 1/2" (38) = 1'-0" (305) - 1:8

1 3/8" flange setback

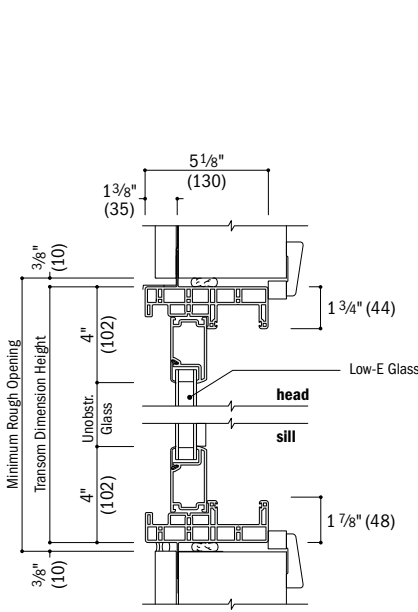

Vertical Section
Patio Door Transom

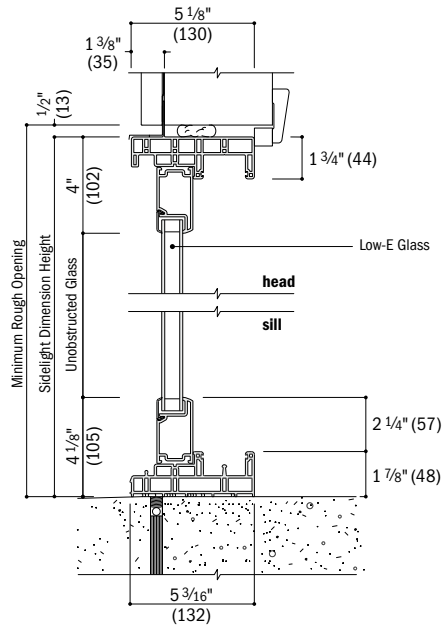

Vertical Section
Patio Door Sidelight

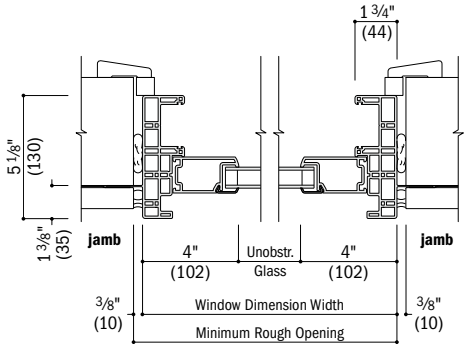

Horizontal Section
Patio Door Sidelight/Transom

1" flange setback with stucco key

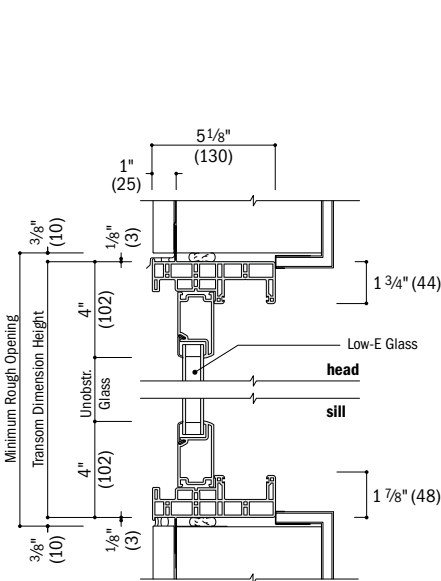

Vertical Section
Patio Door Transom - stucco exterior

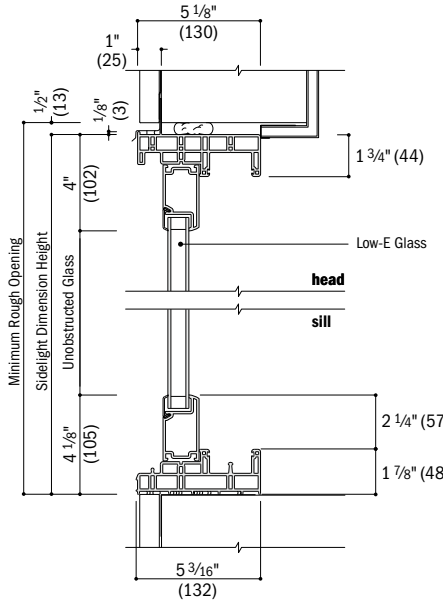

Vertical Section
Patio Door Sidelight - stucco exterior

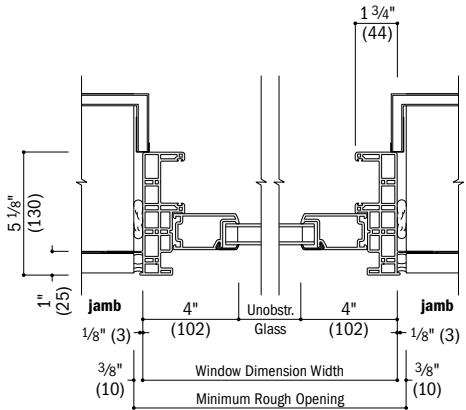

Horizontal Section
Patio Door Sidelight/Transom - stucco exterior

See page 97 for horizontal and vertical joining details.

- Drip cap is required to complete sidelight and transom installation as shown, but may not be included with the sidelight and transom. Use of drip cap is recommended for proper installation.
- **Rough openings may need to be increased to allow for use of building wraps, flashing, sill panning, brackets, fasteners or other items. See installation information on page 109.**
- Details are for illustration only and are not intended to represent product installation methods or materials. Refer to product installation guides at andersenwindows.com.
- Dimensions in parentheses are in millimeters.

Vertical (ribbon) Joining Details

Scale 1 1/2" (38) = 1'-0" (305) – 1:8

Overall Door-Sidelight or Sidelight-Sidelight Dimension Width Sum of individual door-sidelight or sidelight-sidelight widths plus 3/4" (19).

Overall Minimum Rough Opening Width Overall dimension width plus 3/4" (19).

The addition of joining materials will affect the overall rough opening dimension. See page 109.

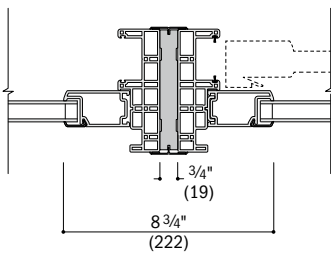

Patio Door Sidelight to Gliding Patio Door
 (patio door stationary jamb)

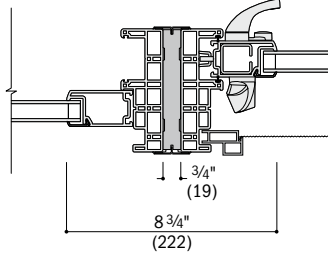

Patio Door Sidelight to Gliding Patio Door
 (patio door operating jamb)

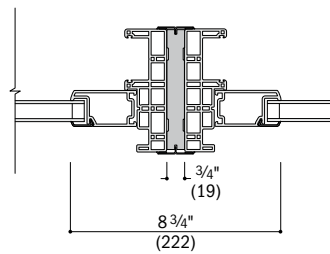

Patio Door Sidelight to Patio Door Sidelight

Horizontal (stack) Joining Details

Scale 1 1/2" (38) = 1'-0" (305) – 1:8

Overall Transom/Door or Transom/Sidelight Dimension Height Sum of individual transom/door or transom/sidelight heights plus 3/4" (19).

Overall Minimum Rough Opening Height Overall dimension height plus 1/2" (13).

The addition of joining materials will affect the overall rough opening dimension. See page 109.

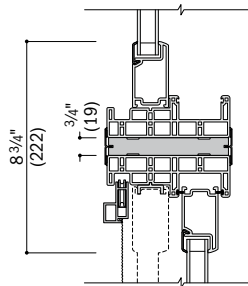

**Patio Door Transom over
 Gliding Patio Door**

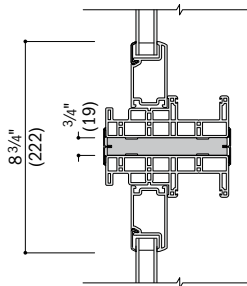

**Patio Door Transom over
 Patio Door Sidelight**

For more information on joining, refer to the combination designs section on page 99.

- Rough openings may need to be increased to allow for use of building wraps, flashing, sill panning, brackets, fasteners or other items. See installation information on page 109.
- Details are for illustration only and are not intended to represent product installation methods or materials. Refer to product installation guides at andersenwindows.com.
- Structural performance of any combination is only as high as the lowest structural performance of any individual window or join in the combination.
- Contact your Andersen supplier for information on meeting wind load requirements for patio door joined combinations.

PATIO DOORS

Custom Sizes & Specifications



100 Series custom-size patio doors and patio door sidelights and transoms are available in 1/8" (3) increments between minimum and maximum widths and heights shown. Some restrictions apply.

Gliding Patio Doors

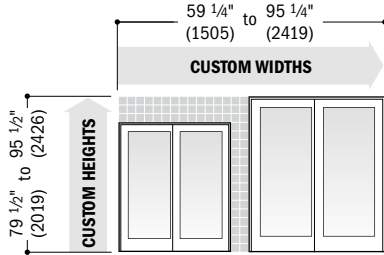

To meet or exceed a clear opening width of 32" (813), select a custom-size door width that requires a rough opening width of 6'6" (1981) or greater.

Clear Opening	Width = (door width + 2) - 6.125" (156) Height = door height - 3.625" (92)	Minimum R.O.	Width = door width + 3/4" (19) Height = door height + 1/2" (13)	Unobstr. Glass	Single-Panel Width = (door width + 2) - 5.500" (140) Two-Panel Width = door width - 11.000" (279) Height = door height - 8.250" (210)

Patio Door Sidelights

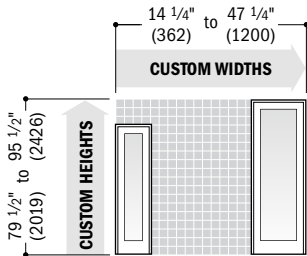

Minimum R.O.	Width = sidelight width + 3/4" (19) Height = sidelight height + 1/2" (13)	Unobstr. Glass	Width = sidelight width - 8.048" (204) Height = sidelight height - 8.048" (204)

Patio Door Transoms

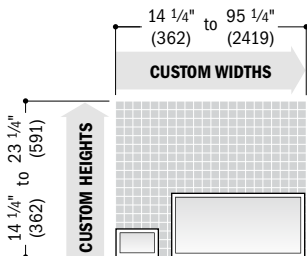

Minimum R.O.	Width = transom width + 3/4" (19) Height = transom height + 3/4" (19)	Unobstr. Glass	Width = transom width - 8.048" (204) Height = transom height - 8.048" (204)

* **Clear Opening** formulas provide dimensions for determining area available for egress. Vent opening, or area available for passage of air, is equal to clear opening. **Minimum R.O.** (minimum rough opening) formulas provide minimum rough opening width and height dimensions. **Unobstr. Glass** (unobstructed glass) formulas provide dimensions for determining area available for passage of light.
* Dimensions in parentheses are in millimeters.

Andersen[®] windows and patio doors make it easy to create a wide variety of combination designs.

Joined Combination Types

Ribbons are horizontal window combinations (vertical joins) where opposite ends (head and sill) of individual windows are fastened to the building structure. Stacks are vertical window combinations (horizontal joins) where opposite sides (both side jambs) of individual windows are fastened to the building structure. One-way configurations or two-way configurations are used in combination designs.

One-Way



Ribbon Combination



Stack Combination

Two-Way

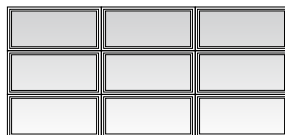

Multiple Ribbon/Stack Combination

Two-way combinations exist when multiple vertical stacks and horizontal ribbons are joined together. Unlike one-way combinations, the adjacent sides (head and sill, or both side jambs) of individual units are not necessarily fastened directly to the building structure. Two-way combinations are joined with both vertical and horizontal joining material and may require reinforced joining materials and brackets depending on the local building code requirement for design wind load (measured in pounds per square foot, PSF).

Determining Design Wind Load Performance

Proper combination design in conformance with local wind load requirements is vital to the success of your project. To make sure a combination is safe and that it complies with local building codes, the combination design wind load performance capacity must be determined. Correctly determining this performance capacity involves the following three steps:

STEP 1: Determine Building Code Requirement

Make sure you have the proper local codes and have identified specified compliance values. This calculated value (PSF) will be used to determine if the combination will be acceptable (STEP 3).



STEP 2: Determine Product Performance

Compare product Design Pressure Rating data to the local building code (PSF) requirement. This will show whether the individual units in a combination design are acceptable.



STEP 3: Determine Combination Performance

This step helps determine whether a given product, size, configuration and joining material type will meet the local building code design wind load requirement. To determine what joining material type to use (non-reinforced or reinforced), compare the local building code design wind load requirement to the Design Wind Load Table value for a particular joining material on the following pages.

For a successful installation, designed to provide the required design pressure, it is important that Andersen joining materials and installation accessories be specified by a project architect or contractor. Andersen joining materials create a joining system that maintains the look of Andersen[®] products without sacrificing performance. Check with your Andersen supplier for more information.

The addition of joining materials will affect the overall rough opening dimension. See page 109. Instruction guides are available at andersenwindows.com. Read and follow instruction guides in their entirety.

Andersen Trim & End Caps – Interior trim is included with each joining kit for finishing the join on the interior. Exterior trim strip and trim strip end caps are included with each kit for finishing exterior join.

Materials vary depending on type of units being joined and wind load requirements. Non-reinforced joining materials are used to create alignment and positive joining between windows. Joining materials are not connected to the rough opening structure.

Reinforced joining materials are used to create product alignment, positive joining and load transfer between the Andersen windows and doors and the rough opening. They provide added strength capable of withstanding a variety of wind load pressures.

The structural performance of any combination is only as high as the lowest structural performance rating of any individual window or joining material in the combination. Please contact your Andersen supplier for specific performance and product recommendations.

COMBINATION DESIGNS

1-Way Non-Reinforced Fiberglass Joining

100 Series Windows: Picture to Picture, Casement to Casement, Awning to Awning, Casement to Picture, Awning to Picture

Applicable for flanged or flangeless installations into wood, metal, concrete or masonry.

Average Adjacent Window Dimension	$(A+B) \div 2 = 6'-0"$ (1829)	50	50	43	37	32	29	26
	$(A+B) \div 2 = 5'-6"$ (1676)	50	50	44	38	33	30	27
	$(A+B) \div 2 = 5'-0"$ (1524)	50	50	45	39	35	31	28
	$(A+B) \div 2 = 4'-6"$ (1372)	50	50	46	41	36	33	30
	$(A+B) \div 2 = 4'-0"$ (1219)	50	50	49	43	39	35	32
	$(A+B) \div 2 = 3'-6"$ (1067)	50	50	50	47	42	39	36
	$(A+B) \div 2 = 3'-0"$ (914)	50	50	50	50	47	43	40
	$(A+B) \div 2 = 2'-6"$ (762)	50	50	50	50	50	50	46
	$(A+B) \div 2 = 2'-0"$ (610)	50	50	50	50	50	50	50
C = (length of join)	5'-0" (1524)	5'-6" (1676)	6'-0" (1829)	6'-6" (1981)	7'-0" (2134)	7'-6" (2286)	8'-0" (2438)	

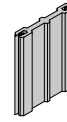
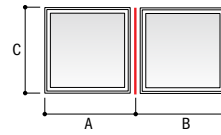

3 1/4" (83) x 1/2" (13)
Fiberglass Joining Material

1-Way Non-Reinforced Fiberglass Joining

100 Series Windows: Single-Hung to Picture, Gliding to Picture

Applicable for flanged or flangeless installations into wood, metal, concrete or masonry.

Avg. Adjacent Window Dim.	$(A+B) \div 2 = 5'-0"$ (1524)	50	50	45	39	35	31	28
	$(A+B) \div 2 = 4'-6"$ (1372)	50	50	46	41	36	33	30
	$(A+B) \div 2 = 4'-0"$ (1219)	50	50	49	43	39	35	32
	$(A+B) \div 2 = 3'-6"$ (1067)	50	50	50	47	42	39	36
	$(A+B) \div 2 = 3'-0"$ (914)	50	50	50	50	47	43	40
	$(A+B) \div 2 = 2'-6"$ (762)	50	50	50	50	50	50	46
	$(A+B) \div 2 = 2'-0"$ (610)	50	50	50	50	50	50	50
C = (length of join)	5'-0" (1524)	5'-6" (1676)	6'-0" (1829)	6'-6" (1981)	7'-0" (2134)	7'-6" (2286)	8'-0" (2438)	

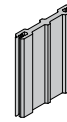
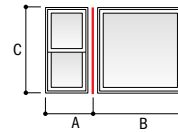

3 1/4" (83) x 1/2" (13)
Fiberglass Joining Material

1-Way Non-Reinforced Fiberglass Joining

100 Series Windows: Single-Hung to Single-Hung, Gliding to Gliding, Single-Hung to Casement, Single-Hung to Awning

Applicable for flanged or flangeless installations into wood, metal, concrete or masonry.

Avg. Adj. Window Dim.	$(A+B) \div 2 = 4'-0"$ (1219)	50	50	49	43	39	34	30
	$(A+B) \div 2 = 3'-6"$ (1067)	50	50	50	47	42	38	33
	$(A+B) \div 2 = 3'-0"$ (914)	50	50	50	50	47	43	38
	$(A+B) \div 2 = 2'-6"$ (762)	50	50	50	50	50	50	45
	$(A+B) \div 2 = 2'-0"$ (610)	50	50	50	50	50	50	50
C = (length of join)	5'-0" (1524)	5'-6" (1676)	6'-0" (1829)	6'-6" (1981)	7'-0" (2134)	7'-6" (2286)	8'-0" (2438)	

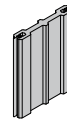
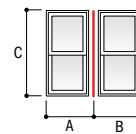

3 1/4" (83) x 1/2" (13)
Fiberglass Joining Material

• Numerical values in charts represent structural pressure only.

• Structural performance of any combination is only as high as the lowest structural performance of any individual unit or joining material in the combination.

• Andersen products must be installed and anchored properly according to joining and installation guides to meet rated structural performance. Refer to product joining and installation guides at andersenwindows.com.

• Single transom windows use "picture" frame type. Integral transom windows use "single-hung" frame type. Combination performance should be determined accordingly.

• Dimensions in parentheses are in millimeters.

1-Way Reinforced Fiberglass Joining

100 Series Windows: Casement, Awning, Picture, Single-Hung, Gliding

Applicable for flanged or flangeless installations into wood, metal, concrete or masonry.

Average Adjacent Window Dimension	(A + B) ÷ 2 = 8'-0" (2438)	50	50	50	50	50	50	50	50	50	50	50	50	50	50	50	50	50	50	50	50	50
	(A + B) ÷ 2 = 7'-6" (2286)	50	50	50	50	50	50	50	50	50	50	50	50	50	50	50	50	50	50	50	50	50
	(A + B) ÷ 2 = 7'-0" (2134)	50	50	50	50	50	50	50	50	50	50	50	50	50	50	50	50	50	50	50	50	50
	(A + B) ÷ 2 = 6'-6" (1981)	50	50	50	50	50	50	50	50	50	50	50	50	50	50	50	50	50	50	50	50	50
	(A + B) ÷ 2 = 6'-0" (1829)	50	50	50	50	50	50	50	50	50	50	50	50	50	50	50	50	50	50	50	50	50
	(A + B) ÷ 2 = 5'-6" (1676)	50	50	50	50	50	50	50	50	50	50	50	50	50	50	50	50	50	50	50	50	50
	(A + B) ÷ 2 = 5'-0" (1524)	50	50	50	50	50	50	50	50	50	50	50	50	50	50	50	50	50	50	50	50	50
	(A + B) ÷ 2 = 4'-6" (1372)	50	50	50	50	50	50	50	50	50	50	50	50	50	50	50	50	50	50	50	50	50
	(A + B) ÷ 2 = 4'-0" (1219)	50	50	50	50	50	50	50	50	50	50	50	50	50	50	50	50	50	50	50	50	50
	(A + B) ÷ 2 = 3'-9" (1372)	50	50	50	50	50	50	50	50	50	50	50	50	50	50	50	50	50	50	50	50	50
	(A + B) ÷ 2 = 3'-6" (1067)	50	50	50	50	50	50	50	50	50	50	50	50	50	50	50	50	50	50	50	50	50
	(A + B) ÷ 2 = 3'-0" (914)	50	50	50	50	50	50	50	50	50	50	50	50	50	50	50	50	50	50	50	50	50
	(A + B) ÷ 2 = 2'-6" (762)	50	50	50	50	50	50	50	50	50	50	50	50	50	50	50	50	50	50	50	50	50
	(A + B) ÷ 2 = 2'-0" (610)	50	50	50	50	50	50	50	50	50	50	50	50	50	50	50	50	50	50	50	50	50
	(A + B) ÷ 2 = 1'-6" (457)	50	50	50	50	50	50	50	50	50	50	50	50	50	50	50	50	50	50	50	50	50
C = (length of join)	2'-0" (610)	2'-6" (762)	3'-0" (914)	3'-6" (1067)	4'-0" (1219)	4'-6" (1372)	5'-0" (1524)	5'-6" (1676)	6'-0" (1829)	6'-6" (1981)	7'-0" (2134)	7'-6" (2286)	8'-0" (2438)	8'-6" (2591)	9'-0" (2743)	9'-6" (2896)	10'-0" (3048)	10'-6" (3200)	11'-0" (3353)	11'-6" (3505)	12'-0" (3658)	

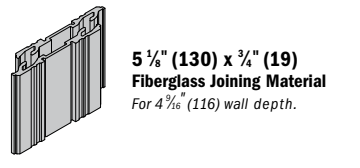
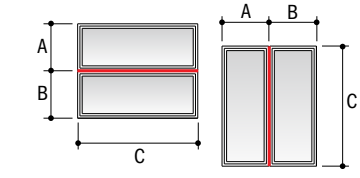

5 1/8" (130) x 3/4" (19) Fiberglass Joining Material
For 4 7/8" (116) wall depth.

2-Way Reinforced Fiberglass Joining*

100 Series Windows: Casement, Awning, Picture, Single-Hung, Gliding

Applicable for flanged or flangeless installations into wood, metal, concrete or masonry.

Average Adjacent Window Dimension	(A + B) ÷ 2 = 6'-0" (1829)	50	50	50	50	50	50	50	50	50	50	50	50	50	49	44	40	26	23	21	20	
	(A + B) ÷ 2 = 5'-6" (1676)	50	50	50	50	50	50	50	50	50	50	50	50	50	50	50	48	43	28	26	23	21
	(A + B) ÷ 2 = 5'-0" (1524)	50	50	50	50	50	50	50	50	50	50	50	50	50	50	50	50	48	32	30	26	24
	(A + B) ÷ 2 = 4'-6" (1372)	50	50	50	50	50	50	50	50	50	50	50	50	50	50	50	50	50	36	33	27	25
	(A + B) ÷ 2 = 4'-0" (1219)	50	50	50	50	50	50	50	50	50	50	50	50	50	50	50	50	50	41	37	30	28
	(A + B) ÷ 2 = 3'-9" (1372)	50	50	50	50	50	50	50	50	50	50	50	50	50	50	50	50	50	43	40	32	30
	(A + B) ÷ 2 = 3'-6" (1067)	50	50	50	50	50	50	50	50	50	50	50	50	50	50	50	50	50	47	42	35	32
	(A + B) ÷ 2 = 3'-0" (914)	50	50	50	50	50	50	50	50	50	50	50	50	50	50	50	50	50	50	50	40	37
	(A + B) ÷ 2 = 2'-6" (762)	50	50	50	50	50	50	50	50	50	50	50	50	50	50	50	50	50	50	50	43	40
	(A + B) ÷ 2 = 2'-0" (610)	50	50	50	50	50	50	50	50	50	50	50	50	50	50	50	50	50	50	50	50	50
(A + B) ÷ 2 = 1'-6" (457)	50	50	50	50	50	50	50	50	50	50	50	50	50	50	50	50	50	50	50	50	50	
C = (length of join)	2'-0" (610)	2'-6" (762)	3'-0" (914)	3'-6" (1067)	4'-0" (1219)	4'-6" (1372)	5'-0" (1524)	5'-6" (1676)	6'-0" (1829)	6'-6" (1981)	7'-0" (2134)	7'-6" (2286)	8'-0" (2438)	8'-6" (2591)	9'-0" (2743)	9'-6" (2896)	10'-0" (3048)	10'-6" (3200)	11'-0" (3353)	11'-6" (3505)	12'-0" (3658)	

Red lines represent reinforced joins.
Blue lines represent non-reinforced joins.

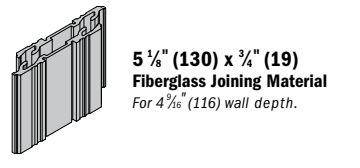
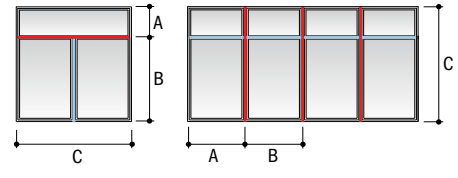

5 1/8" (130) x 3/4" (19) Fiberglass Joining Material
For 4 7/8" (116) wall depth.

1-Way LVL Joining

100 Series Patio Doors: Gliding Patio Doors, Patio Door Sidelights & Transoms

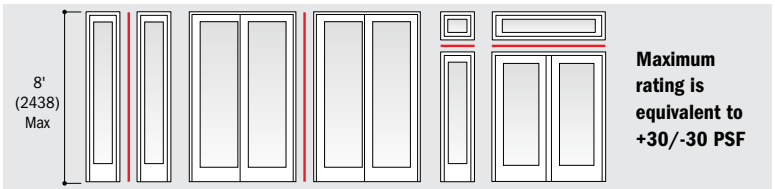

- * Numerical values in charts represent structural pressure only.
- * Structural performance of any combination is only as high as the lowest structural performance of any individual unit or joining material in the combination.
- * Performance of two-way combinations may be limited by non-reinforced joins 6' (1829) or greater in length. Verify performance of non-reinforced joins within two-way combinations using the appropriate non-reinforced joining table.
- * Andersen products must be installed and anchored properly according to joining and installation guides to meet rated structural performance. Refer to product joining and installation guides at andersenwindows.com.
- * Single transom windows use "picture" frame type. Integral transom windows use "single-hung" frame type. Combination performance should be determined accordingly.
- * All two-way joining requires both non-reinforced and reinforced elements. Intersecting reinforced or non-reinforced joints are not available.
- * Dimensions in parentheses are in millimeters.

Combination Designs, Product Performance & Installation

PERFORMANCE STANDARDS

The Window and Door Manufacturers Association (WDMA), the American Architectural Manufacturers Association (AAMA) and the Canadian Standards Association (CSA) jointly release the North American Fenestration Standard/Specification for Windows, Doors and Skylights (NAFS-11) where "-11" refers to the most recent publication year of 2011. NAFS is also referred to as AAMA/WDMA/CSA 101/I.S.2/A440, which is how the International Code Council (ICC) lists this standard in the 2012 and 2015 International Residential Code (IRC) and International Building Code (IBC) as the means to indicate the window, door or skylights design pressure rating used to determine compliance to the jobsite design pressure requirements.

A product only achieves a "Performance Grade" or "PG" rating when it complies with all of the NAFS performance requirements such as ease of operation, air infiltration resistance, resistance to water penetration and resistance to forced entry, etc. A "Design Pressure Rating" or "DP" rating only depicts the design and structural load performance.

Performance Classes

The NAFS Standard/Specification defines requirements for four performance classes. Performance classes are designated R, LC, CW, and AW. This classification system provides for several levels of performance. Product selection is always based on the performance and building code requirements of the particular project.

Elements of Performance Grade (PG) Designations

In order to qualify for a given performance grade (PG), test specimens need to pass all required performance tests for the following, in addition to all required auxiliary (durability) and applicable material/component tests (not shown here) for the applicable product type and desired performance class:

- (a) Operating force (if applicable):** Maximum operating force varies by product type and performance class.
- (b) Air leakage resistance:** Tested in accordance with ASTM E283 at a test pressure of 1.57 psf. Allowable air infiltration for R, LC and CW class designations is 0.3 cubic feet per minute per square foot of frame (cfm/ft²).
- (c) Water penetration resistance:** Tested in accordance with ASTM E547 with the specified test pressure applied per NAFS-11. Test consists of four cycles. Each cycle consists of five minutes with pressure applied and one minute with the pressure released, during which the water spray is continuously applied. Water spray shall be uniformly applied at a constant rate of 5 U.S. gal/ft² · hr.
- (d) Uniform load deflection test:** Tested in accordance with ASTM E330 for both positive and negative pressure (pressure defined by NAFS-11) with the load maintained for a period of 10 seconds. The test specimen shall be evaluated for deflection during each load for permanent damage after each load and for any effects on the normal operation of the specimen. *Starting with the 2008 version of NAFS, design pressure (DP) will only represent the "uniform load deflection test".*
- (e) Uniform load structural test:** Tested in accordance with ASTM E330 for both positive and negative pressure (pressure defined by NAFS-11) with the load maintained for a period of 10 seconds. After loads are removed, there shall be no permanent deformation in excess of 0.4% of its span and no damage to the unit, which would make it inoperable.
- (f) Forced-entry resistance (if applicable):** Tested in accordance with ASTM F588 (windows), F476 (swinging doors) and F842 (sliding doors) at a performance level 10 rating.

Performance Grades (PG) & Corresponding Test Pressures (psf)

Performance Class/ Performance Grade		Air Infiltration Test Pressure		Maximum Allowable Air Infiltration/ Infiltration Rate		Water Penetration Resistance Test Pressure		Design Pressure		Structural Test Pressure	
R	LC	Pa	psf	L/s·m ²	cfm/ft ²	Pa	psf	Pa	psf	Pa	psf
15	-	75	1.57	1.5	0.30	140	2.92	720	15.04	1080	22.56
20	-	75	1.57	1.5	0.30	150	3.13	960	20.05	1440	30.08
25	25	75	1.57	1.5	0.30	180	3.76	1200	25.06	1800	37.59
30	30	75	1.57	1.5	0.30	220	4.59	1440	30.08	2160	45.11
35	35	75	1.57	1.5	0.30	260	5.43	1680	35.09	2520	52.63
40	40	75	1.57	1.5	0.30	290	6.06	1920	40.10	2880	60.15
45	45	75	1.57	1.5	0.30	330	6.89	2160	45.11	3240	67.67
50	50	75	1.57	1.5	0.30	360	7.52	2400	50.13	3600	75.19
55	55	75	1.57	1.5	0.30	400	8.35	2640	55.14	3960	82.71
60	60	75	1.57	1.5	0.30	440	9.19	2880	60.15	4320	90.23
65	65	75	1.57	1.5	0.30	470	9.82	3120	65.16	4680	97.74
70	70	75	1.57	1.5	0.30	510	10.65	3360	70.18	5040	105.26
75	75	75	1.57	1.5	0.30	540	11.28	3600	75.19	5400	112.78
80	80	75	1.57	1.5	0.30	580	12.11	3840	80.20	5760	120.30
85	85	75	1.57	1.5	0.30	580	12.11	4080	85.21	6120	127.82
90	90	75	1.57	1.5	0.30	580	12.11	4320	90.23	6480	135.34
95	95	75	1.57	1.5	0.30	580	12.11	4560	95.24	6840	142.86
100	100	75	1.57	1.5	0.30	580	12.11	4800	100.25	7200	150.38

HALLMARK CERTIFICATION

The Window and Door Manufacturers Association (WDMA)-sponsored Hallmark Certification Program provides manufacturers with certification to the AAMA/WDMA/CSA 101/I.S.2/A440-11 Standard and is designed to provide builders, architects, specifiers and consumers with an easily recognizable means of identifying products that have been manufactured and tested in accordance with NAFS (AAMA/WDMA/CSA 101/I.S.2/A440) industry standards and other applicable performance standards. Conformance is determined by periodic in-plant inspections by a third-party administrator. Inspections include auditing licensee quality control procedures and processes and a review to confirm products are manufactured in accordance with the appropriate performance standards. Periodic testing of representative product constructions and components by an independent testing laboratory is also required. When all of the program requirements are met, the licensee is authorized to use the WDMA Hallmark registered logo on their certification label as a means of identifying products and their performance ratings.

Products successfully obtaining Hallmark Certification will be labeled with a three-part code, which includes performance class, performance grade and size tested. In addition to this mandatory requirement, you are allowed to list the design pressure on a separate line.

	Andersen Corporation 100 SERIES CASEMENT WINDOW Manufacturer stipulates certification as indicated below.					
	<table border="1"> <thead> <tr> <th>STANDARD</th> <th>RATING</th> </tr> </thead> <tbody> <tr> <td>AAMA/WDMA/CSA 101/I.S.2/A440-11</td> <td>Class LC⁽¹⁾ - PG40⁽²⁾ - Size Tested 71.5 x 71.5 in.⁽³⁾ DP+40/-45⁽⁴⁾</td> </tr> <tr> <td>AAMA/WDMA/CSA 101/I.S.2/A440-08</td> <td>Class LC⁽¹⁾ - PG40⁽²⁾ - Size Tested 71.5 x 71.5 in.⁽³⁾ DP+40/-45⁽⁴⁾</td> </tr> </tbody> </table>	STANDARD	RATING	AAMA/WDMA/CSA 101/I.S.2/A440-11	Class LC ⁽¹⁾ - PG40 ⁽²⁾ - Size Tested 71.5 x 71.5 in. ⁽³⁾ DP+40/-45 ⁽⁴⁾	AAMA/WDMA/CSA 101/I.S.2/A440-08
STANDARD	RATING					
AAMA/WDMA/CSA 101/I.S.2/A440-11	Class LC ⁽¹⁾ - PG40 ⁽²⁾ - Size Tested 71.5 x 71.5 in. ⁽³⁾ DP+40/-45 ⁽⁴⁾					
AAMA/WDMA/CSA 101/I.S.2/A440-08	Class LC ⁽¹⁾ - PG40 ⁽²⁾ - Size Tested 71.5 x 71.5 in. ⁽³⁾ DP+40/-45 ⁽⁴⁾					

- (1) - Performance Class
- (2) - Performance Grade
- (3) - Size Tested
- (4) - Design Pressure

In the example above, the performance class is LC, the performance grade (PG) is 40 pounds per square foot (psf) and the size tested is 71.5" x 71.5". What this means to the specifier is, based on the performance grade chart, the laboratory-tested air infiltration was less than 0.3 cfm/ft² (test pressure is always 1.57 psf and the allowable airflow is 0.3 cfm/ft²), the product tested successfully resisted a laboratory water penetration test at a test pressure of 6.0 psf, the product tested successfully withstood a laboratory positive test pressure of 60 psf and a laboratory negative test pressure of 67 psf and the product tested passed the laboratory requirements for operational force and forced-entry resistance. Based on this test, all products of the same design that are smaller than the tested size can be labeled with this product performance rating.

IMPORTANT

Building codes prescribe design pressure based on a variety of criteria (i.e. windspeed zone, building height, building type, jobsite exposure, etc.). Design pressures derived from Performance Grade (PG) test requirements should be used to determine compliance to building code required design pressures. Structural test pressures, which are tested at 1.5 times the design pressure, should not be used for determining design pressure code compliance. In the example above, a PG 40 performance grade rating, which passes a 40 psf design pressure, should be used for determining code compliance, not the structural test pressure of 60 psf.

If you need further details about how Andersen® products perform to this standard, contact your Andersen supplier.

If you need further information about the AAMA/WDMA/CSA 101/I.S.2/A440-11 standard or the Hallmark Certification Program, please contact: WDMA, 330 N. Wabash Avenue Suite 2000, Chicago, IL 60611 Phone: 312-673-4828 Web: wdma.com

Where designated, Andersen products are tested, certified and labeled to the requirements of the Hallmark Certification Program. Actual performance may vary based on variations in manufacturing, shipping, installation, environmental conditions and conditions of use.

Combination Designs, Product Performance & Installation

PRODUCT PERFORMANCE

Performance Grade, Air Infiltration and Sound Transmission Ratings – 100 Series Windows and Patio Doors

For current performance information, please visit andersenwindows.com.

Andersen® Product	AAMA/WDMA/CSA 101/I.S.2/A440 Performance Grade (PG)	+/- Corresponding Design Pressure (DP)	STANDARD GLASS		STC UPGRADE GLASS		Air Infiltration CFM/FT ²
			Sound Transmission Class (STC)	Outdoor/Indoor Transmission Class (OITC)	Sound Transmission Class (STC)	Outdoor/Indoor Transmission Class (OITC)	
Casement Windows							
Single & Twin (venting/stationary)	Class LC-PG40 Size Tested 71.5" x 71.5"	+40/-45	30	25	33	28	< 0.2
Single & Twin, PG Upgrade (venting/stationary)	Class LC-PG50 Size Tested 71.5" x 71.5"	+50/-50*	30	25	33	28	< 0.2
Picture with Flanking Casements	Class LC-PG40 Size Tested 143.5" x 71.5"	+40/-45	-	-	-	-	< 0.2
Picture with Flanking Casements, PG Upgrade	Class LC-PG50 Size Tested 143.5" x 65.5"	+50/-50*	-	-	-	-	< 0.2
Awning Windows							
Single & Twin (venting/stationary)	Class LC-PG40 Size Tested 47.5" x 95.5"	+40/-45	30	25	33	28	< 0.2
Single & Twin, PG Upgrade (venting/stationary)	Class LC-PG50 Size Tested 47.5" x 95.5"	+50/-50*	30	25	33	28	< 0.2
Picture over Awning	Class LC-PG40 Size Tested 47.5" x 95.5"	+40/-45	-	-	-	-	< 0.2
Picture over Awning, PG Upgrade	Class LC-PG50 Size Tested 47.5" x 95.5"	+50/-50*	-	-	-	-	< 0.2
Single-Hung Windows							
Arch Single-Hung	Class LC-PG30 Size Tested 41.5" x 95.0"	+30/-30	-	-	-	-	< 0.2
Arch Single-Hung, PG Upgrade	Class LC-PG50 Size Tested 41.5" x 83.0"	+50/-50*	-	-	-	-	< 0.2
Single-Hung	Class LC-PG30 Size Tested 47.5" x 89.5"	+30/-30	28	23	32	26	< 0.2
Single-Hung, PG Upgrade	Class LC-PG50 Size Tested 47.5" x 77.5"	+50/-50*	28	23	32	26	< 0.2
Twin & Triple Single-Hung	Class LC-PG30 Size Tested 143.5" x 71.5"	+30/-30	-	-	-	-	< 0.2
Twin & Triple Single-Hung, PG Upgrade	Class LC-PG50 Size Tested 143.5" x 65.5"	+50/-50*	-	-	-	-	< 0.2
Transom over Single-Hung	Class LC-PG30 Size Tested 47.5" x 95.5"	+30/-30	-	-	-	-	< 0.2
Transom over Single-Hung, PG Upgrade	Class LC-PG50 Size Tested 47.5" x 95.5"	+50/-50*	-	-	-	-	< 0.2
Picture with Flanking Single-Hungs	Class LC-PG30 Size Tested 143.5" x 71.5"	+30/-30	-	-	-	-	< 0.2
Picture with Flanking Single-Hungs, PG Upgrade	Class LC-PG50 Size Tested 143.5" x 59.5"	+50/-50*	-	-	-	-	< 0.2
Gliding Windows							
Gliding - Active-Stationary or Stationary-Active	Class LC-PG30 Size Tested 71.5" x 71.5"	+30/-30	28	23	32	27	< 0.2
Gliding, PG Upgrade - Active-Stationary or Stationary-Active	Class LC-PG50 Size Tested 71.5" x 59.5"	+50/-50*	28	23	32	27	< 0.2
Picture over Gliding - Active-Stationary or Stationary-Active	Class LC-PG30 Size Tested 59.5" x 83.5"	+30/-30	-	-	-	-	< 0.2
Gliding - Active-Stationary-Active	Class LC-PG30 Size Tested 143.5" x 71.5"	+30/-30**	-	-	-	-	< 0.2
Gliding, PG Upgrade - Active-Stationary-Active	Class LC-PG50 Size Tested 101.5" x 59.5"	+50/-50*	-	-	-	-	< 0.2
Picture over Gliding - Active-Stationary-Active	Class LC-PG30 Size Tested 107.5" x 83.5"	+30/-30**	-	-	-	-	< 0.2
Picture, Transom & Specialty Windows							
Picture, Transom & Specialty Windows	Class LC-PG40 Size Tested 95.5" x 84.3"	+40/-40	29	24	32	27	< 0.2
Picture, Transom & Specialty Windows, PG Upgrade	Class LC-PG50 Size Tested 95.5" x 71.5"	+50/-50*	29	24	32	27	< 0.2
Gliding Patio Doors							
Gliding Patio Doors	Class LC-PG30 Size Tested 95.3" x 95.5"	+30/-30	28	23	29	26	< 0.2
Patio Door Transoms	Class LC-PG30 Size Tested 95.3" x 23.3"	+30/-30	29	24	31	26	< 0.2
Patio Door Sidelights	Class LC-PG30 Size Tested 47.3" x 95.3"	+30/-30	29	24	31	26	< 0.2

- *"Performance Grade (PG)" ratings may vary from tested performance rating for larger or smaller units of a particular type.
- *"Sound Transmission Class (STC)" & "Outdoor/Indoor Transmission Class (OITC)" ratings are for individual units with 3mm glass based on independent tests and represent entire unit.
- *This data is accurate as of June 2019. Due to ongoing product changes, updated test results, or new industry standards, this data may change over time.
- *Where designated, Andersen products are certified and labeled to the requirements of the Hallmark Certification Program. Actual performance may vary based on variations in manufacturing, shipping, installation, environmental conditions and conditions of use.
- *Contact your Andersen supplier for more information.
- *Available for select sizes, contact your Andersen supplier.
- **Windows with insert frame (no flange with exterior accessory kerf) are rated at PG20.

Andersen® Products Total Unit Recycled Content Percentages

For current performance information, please visit andersenwindows.com.

Andersen Product	% Pre-Consumer Recycled Content
100 Series Windows and Patio Doors	
Casement Windows	23%
Awning Windows	24%
Single-Hung Windows	20%
Gliding Windows	21%
Picture Windows	18%
Gliding Patio Doors	14%
Patio Door Sidelights	18%
Patio Door Transoms	21%

- *"% Pre-Consumer Recycled Content" is verified by SCS Global Services (SCS) to meet I.S.O 14021 standards based on NFRC sizing. Actual recycled content dependent on product size.
- *Dimensions in parentheses are in millimeters.

Center of Glass Performance Data – 100 Series Windows and Patio Doors

For current performance information, please visit andersenwindows.com.

Andersen® Product and Glass Type	VLT ¹	SC ²	SHGC ³	RHG ⁴	Fading		%RH @ center ³	IGST ⁸
					Tuv ⁵	Tdw ⁶		
High-Performance Low-E Glass								
Casement, Awning, Single-Hung & Gliding Windows	72%	0.48	0.41	98.2	16%	33%	61%	55.7
Picture, Transom & Specialty Windows	72%	0.47	0.41	97.5	16%	33%	60%	55.3
Gliding Patio Doors	72%	0.47	0.41	97.5	16%	33%	60%	55.3
Patio Door Sidelights & Transoms	72%	0.47	0.41	97.5	16%	33%	60%	55.3
High-Performance Low-E SmartSun™ Glass								
Casement, Awning, Single-Hung & Gliding Windows	65%	0.31	0.27	65.6	5%	21%	62%	56.1
Picture, Transom & Specialty Windows	65%	0.31	0.27	64.9	5%	21%	61%	55.7
Gliding Patio Doors	65%	0.31	0.27	64.9	5%	21%	61%	55.7
Patio Door Sidelights & Transoms	65%	0.31	0.27	64.9	5%	21%	61%	55.7
Dual-Pane Glass								
Casement, Awning, Single-Hung & Gliding Windows	82%	0.89	0.78	186	58%	61%	39%	43.7
Picture, Transom & Specialty Windows	82%	0.89	0.78	186	58%	61%	39%	43.6
Gliding Patio Doors	82%	0.89	0.78	186	58%	61%	39%	43.6
Patio Door Sidelights & Transoms	82%	0.89	0.78	186	58%	61%	39%	43.6

• Based on NFRC testing/simulation conditions using Windows v7.4.6.0 and NFRC validated spectral data. 0°F outside temperature, 70°F inside temperature and 15 mph wind.
 1) Visible Transmittance (VLT) measures how much light comes through the glass. The higher the value, from 0 to 1, the more daylight the glass lets in. Visible Transmittance is measured over the 380 to 760 nanometer portion of the solar spectrum. 2) Shading Coefficient defines the amount of heat gain through the glass compared to a single light of clear 1/8" (3 mm) glass. 3) Solar Heat Gain Coefficient (SHGC) defines the fraction of solar radiation admitted through the glass both directly transmitted and absorbed and subsequently released inward. The lower the value, the less heat is transmitted through the glass. 4) Relative Heat Gain is the amount of heat gain through a glazing incorporating U-Factor and Solar Heat Gain Coefficient. 5) Transmission Ultra-Violet Energy (TUV). The transmission of short-wave energy in the 300-380 nanometer portion of the solar spectrum. The energy can cause fabric fading. 6) Transmission Damage Function (TDW). The transmission of UV and visible light energy in the 300-600 nanometer portion of the solar spectrum. The value includes both the UV and visible light energy that can cause fabric fading. This rating has also been referred to as the Krochmann Damage Function. This rating better predicts fading potential than UV transmission alone. The lower the Damage Function rating, the less transmission of short-wave energy through the glass that can potentially cause fabric fading. Fabric type is also a key component of fading potential. 7) Percent relative humidity before condensation occurs at the center of glass, taken using center of glass temperature. 8) Inside glass surface temperatures are taken at the center of glass.
 • This data is accurate as of June 2019. Due to ongoing product changes, updated test results, or new industry standards, this data may change over time. Contact your Andersen supplier for current performance information or upgrade options.
 • Contact your Andersen supplier or visit andersenwindows.com/nfrc for center of glass performance data on windows with patterned glass, tempered glass and products ordered with capillary breather tubes.

Andersen® NFRC Certified Total Unit Performance

For current performance information, please visit andersenwindows.com.

Andersen Product	High-Performance Glass Type	U-Factor ¹	SHGC ²	VT ³	
100 Series Casement Windows AND-N-84 2.2 mm glass	Low-E	Without Grilles	0.27	0.28	0.48
		Simulated Divided Light Grilles	0.27	0.26	0.43
		Finelight™ Grilles	0.27	0.26	0.43
		Finelight with Exterior Applied Grilles	0.27	0.26	0.43
		Full Divided Light Grilles	0.28	0.26	0.43
		Without Grilles	0.24	0.28	0.47
	Low-E w/HeatLock™	Simulated Divided Light Grilles	0.24	0.25	0.42
		Finelight Grilles	0.24	0.25	0.42
		Finelight with Exterior Applied Grilles	0.24	0.25	0.42
		Full Divided Light Grilles	0.25	0.25	0.42
		Without Grilles	0.27	0.19	0.43
		Simulated Divided Light Grilles	0.27	0.17	0.39
	Low-E SmartSun™	Finelight Grilles	0.27	0.17	0.39
		Finelight with Exterior Applied Grilles	0.27	0.17	0.39
		Full Divided Light Grilles	0.28	0.17	0.39
		Without Grilles	0.24	0.18	0.42
		Simulated Divided Light Grilles	0.24	0.17	0.38
		Finelight Grilles	0.24	0.17	0.38
	Low-E SmartSun™ w/HeatLock	Finelight with Exterior Applied Grilles	0.24	0.17	0.38
		Full Divided Light Grilles	0.25	0.17	0.38
		Without Grilles	0.41	0.53	0.55
		Simulated Divided Light Grilles	0.41	0.48	0.49
		Finelight Grilles	0.41	0.48	0.49
		Finelight with Exterior Applied Grilles	0.41	0.48	0.49
100 Series Awning Windows AND-N-85 2.2 mm glass	Low-E	Without Grilles	0.28	0.28	0.48
		Simulated Divided Light Grilles	0.28	0.26	0.43
		Finelight™ Grilles	0.28	0.26	0.43
		Finelight with Exterior Applied Grilles	0.28	0.26	0.43
		Full Divided Light Grilles	0.28	0.26	0.43
		Without Grilles	0.25	0.28	0.47
	Low-E w/HeatLock™	Simulated Divided Light Grilles	0.25	0.25	0.42
		Finelight Grilles	0.25	0.25	0.42
		Finelight with Exterior Applied Grilles	0.25	0.25	0.42
		Full Divided Light Grilles	0.26	0.25	0.42
		Without Grilles	0.27	0.19	0.43
		Simulated Divided Light Grilles	0.27	0.17	0.39
	Low-E SmartSun™	Finelight Grilles	0.27	0.17	0.39
		Finelight with Exterior Applied Grilles	0.27	0.17	0.39
		Full Divided Light Grilles	0.28	0.17	0.39
		Without Grilles	0.24	0.18	0.42
		Simulated Divided Light Grilles	0.24	0.17	0.38
		Finelight Grilles	0.24	0.17	0.38
	Low-E SmartSun™ w/HeatLock	Finelight with Exterior Applied Grilles	0.24	0.17	0.38
		Full Divided Light Grilles	0.25	0.17	0.38
		Without Grilles	0.42	0.53	0.55
		Simulated Divided Light Grilles	0.42	0.48	0.49
		Finelight Grilles	0.42	0.48	0.49
		Finelight with Exterior Applied Grilles	0.42	0.48	0.49
Dual-Pane	Without Grilles	0.42	0.53	0.55	
	Simulated Divided Light Grilles	0.42	0.48	0.49	
	Finelight Grilles	0.42	0.48	0.49	
	Finelight with Exterior Applied Grilles	0.42	0.48	0.49	
	Without Grilles	0.42	0.48	0.49	
	Full Divided Light Grilles	0.42	0.48	0.49	

Refer to notes on page 106 for important information on performance data.

Andersen Product	High-Performance Glass Type	U-Factor ¹	SHGC ²	VT ³	
100 Series Single-Hung Windows AND-N-80 2.2 mm glass	Low-E	Without Grilles	0.30	0.32	0.54
		Simulated Divided Light Grilles	0.30	0.28	0.48
		Finelight™ Grilles	0.30	0.28	0.48
		Finelight with Exterior Applied Grilles	0.30	0.28	0.48
		Full Divided Light Grilles	0.31	0.28	0.48
		Without Grilles	0.26	0.31	0.53
	Low-E w/HeatLock™	Simulated Divided Light Grilles	0.26	0.28	0.47
		Finelight Grilles	0.26	0.28	0.47
		Finelight with Exterior Applied Grilles	0.26	0.28	0.47
		Full Divided Light Grilles	0.28	0.28	0.47
		Without Grilles	0.29	0.21	0.49
		Simulated Divided Light Grilles	0.29	0.19	0.43
	Low-E SmartSun™	Finelight Grilles	0.29	0.19	0.43
		Finelight with Exterior Applied Grilles	0.29	0.19	0.43
		Full Divided Light Grilles	0.30	0.19	0.43
		Without Grilles	0.25	0.20	0.47
		Simulated Divided Light Grilles	0.25	0.19	0.42
		Finelight Grilles	0.25	0.19	0.42
	Low-E SmartSun™ w/HeatLock	Finelight with Exterior Applied Grilles	0.25	0.19	0.42
		Full Divided Light Grilles	0.27	0.19	0.42
		Without Grilles	0.46	0.59	0.62
		Simulated Divided Light Grilles	0.46	0.53	0.55
		Finelight Grilles	0.46	0.53	0.55
		Finelight with Exterior Applied Grilles	0.46	0.53	0.55
100 Series Gliding Windows AND-N-81 2.2 mm glass	Low-E	Without Grilles	0.30	0.32	0.54
		Simulated Divided Light Grilles	0.30	0.28	0.48
		Finelight™ Grilles	0.30	0.28	0.48
		Finelight with Exterior Applied Grilles	0.30	0.28	0.48
		Full Divided Light Grilles	0.31	0.28	0.48
		Without Grilles	0.26	0.31	0.53
	Low-E w/HeatLock™	Simulated Divided Light Grilles	0.26	0.28	0.47
		Finelight Grilles	0.26	0.28	0.47
		Finelight with Exterior Applied Grilles	0.26	0.28	0.47
		Full Divided Light Grilles	0.28	0.28	0.47
		Without Grilles	0.29	0.21	0.49
		Simulated Divided Light Grilles	0.29	0.19	0.43
	Low-E SmartSun™	Finelight Grilles	0.29	0.19	0.43
		Finelight with Exterior Applied Grilles	0.29	0.19	0.43
		Full Divided Light Grilles	0.30	0.19	0.43
		Without Grilles	0.26	0.20	0.47
		Simulated Divided Light Grilles	0.26	0.19	0.42
		Finelight Grilles	0.26	0.19	0.42
	Low-E SmartSun™ w/HeatLock	Finelight with Exterior Applied Grilles	0.26	0.19	0.42
		Full Divided Light Grilles	0.27	0.19	0.42
		Without Grilles	0.46	0.60	0.62
		Simulated Divided Light Grilles	0.46	0.53	0.55
		Finelight Grilles	0.46	0.53	0.55
		Finelight with Exterior Applied Grilles	0.46	0.53	0.55
Dual-Pane	Without Grilles	0.46	0.60	0.62	
	Simulated Divided Light Grilles	0.46	0.53	0.55	
	Finelight Grilles	0.46	0.53	0.55	
	Finelight with Exterior Applied Grilles	0.46	0.53	0.55	
	Without Grilles	0.46	0.60	0.62	
	Full Divided Light Grilles	0.46	0.53	0.55	

Combination Designs.
Product Performance &
Installation

• This data is accurate as of June 2019. Due to ongoing product changes, updated test results, or new industry standards or requirements, this data may change over time. Ratings are for sizes specified by NFRC for testing and certification. Ratings may vary depending on use of tempered glass, different grille options, glass for high altitudes, etc.

continued on next page

PRODUCT PERFORMANCE

Andersen® NFRC Certified Total Unit Performance (continued)

For current performance information, please visit andersenwindows.com.

Andersen Product	High-Performance Glass Type	U-Factor ¹	SHGC ²	VT ³	
100 Series Picture & Specialty Windows AND-N-82 3.0 mm glass	Low-E	Without Grilles	0.28	0.33	0.56
		Simulated Divided Light Grilles	0.28	0.29	0.50
		Finelight™ Grilles	0.28	0.29	0.50
		Finelight with Exterior Applied Grilles	0.28	0.29	0.50
		Full Divided Light Grilles	0.29	0.29	0.50
	Low-E w/HeatLock™	Without Grilles	0.24	0.32	0.55
		Simulated Divided Light Grilles	0.24	0.29	0.49
		Finelight Grilles	0.24	0.29	0.49
		Finelight with Exterior Applied Grilles	0.24	0.29	0.49
		Full Divided Light Grilles	0.25	0.29	0.49
	Low-E SmartSun™	Without Grilles	0.27	0.22	0.50
		Simulated Divided Light Grilles	0.27	0.20	0.45
		Finelight Grilles	0.27	0.20	0.45
		Finelight with Exterior Applied Grilles	0.27	0.20	0.45
	Low-E SmartSun w/HeatLock	Without Grilles	0.23	0.21	0.49
		Simulated Divided Light Grilles	0.23	0.19	0.44
		Finelight Grilles	0.23	0.19	0.44
		Finelight with Exterior Applied Grilles	0.23	0.19	0.44
	Dual-Pane	Without Grilles	0.45	0.61	0.64
		Simulated Divided Light Grilles	0.45	0.55	0.57
Finelight Grilles		0.45	0.55	0.57	
Finelight with Exterior Applied Grilles		0.45	0.55	0.57	
Full Divided Light Grilles		0.45	0.55	0.57	
100 Series Transom Windows AND-N-83 3.0 mm glass	Low-E	Without Grilles	0.29	0.33	0.56
		Simulated Divided Light Grilles	0.29	0.30	0.50
		Finelight™ Grilles	0.29	0.30	0.50
		Finelight with Exterior Applied Grilles	0.29	0.30	0.50
		Full Divided Light Grilles	0.30	0.30	0.50
	Low-E w/HeatLock™	Without Grilles	0.25	0.32	0.55
		Simulated Divided Light Grilles	0.25	0.29	0.49
		Finelight Grilles	0.25	0.29	0.49
		Finelight with Exterior Applied Grilles	0.25	0.29	0.49
		Full Divided Light Grilles	0.27	0.29	0.49
	Low-E SmartSun™	Without Grilles	0.28	0.22	0.50
		Simulated Divided Light Grilles	0.28	0.20	0.45
		Finelight Grilles	0.28	0.20	0.45
		Finelight with Exterior Applied Grilles	0.28	0.20	0.45
	Low-E SmartSun w/HeatLock	Without Grilles	0.24	0.21	0.49
		Simulated Divided Light Grilles	0.24	0.19	0.44
		Finelight Grilles	0.24	0.19	0.44
		Finelight with Exterior Applied Grilles	0.24	0.19	0.44
	Dual-Pane	Without Grilles	0.46	0.61	0.64
		Simulated Divided Light Grilles	0.46	0.55	0.57
Finelight Grilles		0.46	0.55	0.57	
Finelight with Exterior Applied Grilles		0.46	0.55	0.57	
Full Divided Light Grilles		0.46	0.55	0.57	
100 Series Gliding Patio Doors AND-N-100 3.1 mm glass	Low-E	Without Grilles	0.30	0.32	0.55
		Simulated Divided Light Grilles	0.30	0.25	0.42
		Finelight™ Grilles	0.30	0.29	0.48
		Finelight with Exterior Applied Grilles	0.30	0.25	0.42
		Full Divided Light Grilles	0.31	0.25	0.42
	Low-E w/HeatLock™	Without Grilles	0.25	0.32	0.54
		Simulated Divided Light Grilles	0.25	0.25	0.41
		Finelight Grilles	0.25	0.28	0.47
		Finelight with Exterior Applied Grilles	0.25	0.25	0.41
		Full Divided Light Grilles	0.28	0.25	0.41
	Low-E SmartSun™	Without Grilles	0.29	0.21	0.50
		Simulated Divided Light Grilles	0.29	0.17	0.38
		Finelight Grilles	0.29	0.19	0.44
		Finelight with Exterior Applied Grilles	0.29	0.17	0.38
	Low-E SmartSun w/HeatLock	Without Grilles	0.25	0.21	0.49
		Simulated Divided Light Grilles	0.25	0.17	0.37
		Finelight Grilles	0.25	0.19	0.43
		Finelight with Exterior Applied Grilles	0.25	0.17	0.37
	Dual-Pane	Without Grilles	0.46	0.60	0.63
		Simulated Divided Light Grilles	0.46	0.46	0.48
Finelight Grilles		0.46	0.53	0.55	
Finelight with Exterior Applied Grilles		0.46	0.46	0.48	
Full Divided Light Grilles		0.46	0.46	0.48	

Andersen Product	High-Performance Glass Type	U-Factor ¹	SHGC ²	VT ³	
100 Series Patio Door Transoms AND-N-98 3.0 mm glass	Low-E	Without Grilles	0.32	0.25	0.43
		Simulated Divided Light Grilles	0.32	0.20	0.34
		Finelight™ Grilles	0.32	0.23	0.38
		Finelight with Exterior Applied Grilles	0.32	0.20	0.34
		Full Divided Light Grilles	0.32	0.20	0.34
	Low-E w/HeatLock™	Without Grilles	0.29	0.25	0.42
		Simulated Divided Light Grilles	0.29	0.20	0.33
		Finelight Grilles	0.29	0.22	0.37
		Finelight with Exterior Applied Grilles	0.29	0.20	0.33
		Full Divided Light Grilles	0.30	0.20	0.33
	Low-E SmartSun™	Without Grilles	0.31	0.17	0.38
		Simulated Divided Light Grilles	0.31	0.14	0.30
		Finelight Grilles	0.31	0.15	0.34
		Finelight with Exterior Applied Grilles	0.31	0.14	0.30
	Low-E SmartSun w/HeatLock	Without Grilles	0.28	0.17	0.37
		Simulated Divided Light Grilles	0.28	0.14	0.29
		Finelight Grilles	0.28	0.15	0.33
		Finelight with Exterior Applied Grilles	0.28	0.14	0.29
	Dual-Pane	Without Grilles	0.45	0.47	0.49
		Simulated Divided Light Grilles	0.45	0.38	0.38
Finelight Grilles		0.45	0.42	0.43	
Finelight with Exterior Applied Grilles		0.45	0.38	0.38	
Full Divided Light Grilles		0.44	0.38	0.38	
100 Series Patio Door Sidelights AND-N-97 3.0 mm glass	Low-E	Without Grilles	0.31	0.25	0.43
		Simulated Divided Light Grilles	0.31	0.21	0.34
		Finelight™ Grilles	0.31	0.23	0.38
		Finelight with Exterior Applied Grilles	0.31	0.21	0.34
		Full Divided Light Grilles	0.32	0.21	0.34
	Low-E w/HeatLock™	Without Grilles	0.28	0.25	0.42
		Simulated Divided Light Grilles	0.28	0.20	0.33
		Finelight Grilles	0.28	0.22	0.37
		Finelight with Exterior Applied Grilles	0.28	0.20	0.33
		Full Divided Light Grilles	0.29	0.20	0.33
	Low-E SmartSun™	Without Grilles	0.31	0.17	0.38
		Simulated Divided Light Grilles	0.31	0.14	0.30
		Finelight Grilles	0.31	0.15	0.34
		Finelight with Exterior Applied Grilles	0.31	0.14	0.30
	Low-E SmartSun w/HeatLock	Without Grilles	0.27	0.17	0.38
		Simulated Divided Light Grilles	0.27	0.14	0.30
		Finelight Grilles	0.27	0.15	0.33
		Finelight with Exterior Applied Grilles	0.27	0.14	0.30
	Dual-Pane	Without Grilles	0.44	0.47	0.49
		Simulated Divided Light Grilles	0.44	0.38	0.39
Finelight Grilles		0.44	0.42	0.44	
Finelight with Exterior Applied Grilles		0.44	0.38	0.39	
Full Divided Light Grilles		0.43	0.38	0.39	

1) U-Factor defines the amount of heat loss through the total unit in BTU/hr/ft²·°F. The lower the value, the less heat is lost through the entire product. Window values represent non-tempered glass. Use of tempered glass can increase U-Factor ratings. See andersenwindows.com/nfrc for specific performance values. Door values represent tempered glass. 2) Solar Heat Gain Coefficient (SHGC) defines the fraction of solar radiation admitted through the glass both directly transmitted and absorbed and subsequently released inward. The lower the value, the less heat is transmitted through the product. 3) Visible Transmittance (VT) measures how much light comes through a product (glass and frame). The higher the value, from 0 to 1, the more daylight the product lets in over the product's total unit area. Visible Transmittance is measured over the 380 to 760 nanometer portion of the solar spectrum.

- NFRC ratings are based on modeling by a third-party agency as validated by an independent test lab in compliance with NFRC program and procedural requirements.
- This data is accurate as of June 2019. Due to ongoing product changes, updated test results, or new industry standards or requirements, this data may change over time. Ratings are for sizes specified by NFRC for testing and certification. Ratings may vary depending on unit size, use of tempered glass, different grille options, glass for high altitudes, etc.
- Values are for single units with given pane thickness and 3/4" (19mm) grilles for windows and 1" (25mm) grilles for door products.

About the NFRC

The National Fenestration Rating Council (NFRC) is a nonpartisan coalition of professionals whose purpose is to provide fair, accurate and credible energy performance ratings for fenestration products. NFRC's membership includes manufacturers, suppliers, designers, specifiers, utility companies, government agencies and other building industry representatives.

Andersen Corporation is a founding member of the NFRC and continues to support its work by providing fair, accurate and credible energy performance ratings to consumers and the building industry. If you have any questions about the NFRC, its program or energy performance ratings, write them at: NFRC, 6305 Ivy Lane, Suite 140, Greenbelt, MD 20770. Tel: (301) 589-1776 Website: www.nfrc.org

About the Label

Look for this certification label on every window and patio door you buy. The NFRC section was designed by the National Fenestration Rating Council to provide accurate information that helps you promote the energy efficiency of the homes you build. These ratings allow you – and your customers – to measure and compare the energy performance of similar products. If the product does not have this label, the NFRC has not verified its claims.

Do not remove until final code inspection. Save label for future reference.

ENERGY STAR® Certified in Highlighted Regions
Certifié ENERGY STAR dans les régions en surbrillance

Canada energystar.gc.ca ENERGY STAR U.S. / É.U. energystar.gov									
DO NOT REMOVE UNTIL FINAL INSPECTION/NE PAS RETIRER AVANT L'INSPECTION FINALE									
 National Fenestration Rating Council® CERTIFIED	<div style="text-align: center;"> 100 Series Single Hung Window AND-N-80-01324-00004 Fibrex Composite Frame, Low-E SmartSun HeatLock with Argon Product Type: Single Hung </div>								
ENERGY PERFORMANCE RATINGS									
<table border="1" style="width: 100%; border-collapse: collapse;"> <tr> <td style="text-align: center; padding: 5px;"> U-Factor 0.25 (U.S./I-P) </td> <td style="text-align: center; padding: 5px;"> 1.42 (Metric/SI) </td> </tr> </table>	U-Factor 0.25 (U.S./I-P)	1.42 (Metric/SI)	<table border="1" style="width: 100%; border-collapse: collapse;"> <tr> <td style="text-align: center; padding: 5px;"> Solar Heat Gain Coefficient 0.20 </td> </tr> </table>	Solar Heat Gain Coefficient 0.20					
U-Factor 0.25 (U.S./I-P)	1.42 (Metric/SI)								
Solar Heat Gain Coefficient 0.20									
ADDITIONAL PERFORMANCE RATINGS									
<table border="1" style="width: 100%; border-collapse: collapse;"> <tr> <td style="text-align: center; padding: 5px;"> Visible Transmittance 0.47 </td> <td style="text-align: center; padding: 5px;"> ■ </td> </tr> </table>		Visible Transmittance 0.47	■						
Visible Transmittance 0.47	■								
<small>Manufacturer stipulates that these ratings conform to applicable NFRC procedures for determining whole product performance. NFRC ratings are determined for a fixed set of environmental conditions and a specific product size. NFRC does not recommend any product and does not warrant the suitability of any product for any specific use. Consult manufacturer's literature for other product performance information. www.nfrc.org</small>									
 Hallmark Certified www.wdma.com	Licensee: 129-H-899 Andersen Corporation 100 Series Single Hung Window <small>Manufacturer stipulates Hallmark Certification as indicated below.</small>								
<table border="1" style="width: 100%; border-collapse: collapse;"> <thead> <tr> <th style="width: 50%; text-align: left; padding: 2px;">STANDARD</th> <th style="width: 50%; text-align: left; padding: 2px;">RATING</th> </tr> </thead> <tbody> <tr> <td style="padding: 2px;">AAMA/WDMA/CSA 101/1.S.2/A440-11</td> <td style="padding: 2px;">Class LC-PG30 Size Tested 143.5" x 71.5" DP=20/-30</td> </tr> <tr> <td style="padding: 2px;">AAMA/WDMA/CSA 101/1.S.2/A440-08</td> <td style="padding: 2px;">Class H-LC30 Size Tested 143.5" x 71.5" DP=30/-30</td> </tr> <tr> <td style="padding: 2px;">AAMA/WDMA/CSA 101/1.S.2/A440-08 A440S1-09</td> <td style="padding: 2px;">Class H-LC30 - 3645mm x 1816mm Positive/Negative Design Pressure (DP) = 1440 Pa/-1440 Pa Water Penetration Resistance Test Pressure = 220 Pa Canadian Air Infiltration/Exfiltration = A3</td> </tr> </tbody> </table>		STANDARD	RATING	AAMA/WDMA/CSA 101/1.S.2/A440-11	Class LC-PG30 Size Tested 143.5" x 71.5" DP=20/-30	AAMA/WDMA/CSA 101/1.S.2/A440-08	Class H-LC30 Size Tested 143.5" x 71.5" DP=30/-30	AAMA/WDMA/CSA 101/1.S.2/A440-08 A440S1-09	Class H-LC30 - 3645mm x 1816mm Positive/Negative Design Pressure (DP) = 1440 Pa/-1440 Pa Water Penetration Resistance Test Pressure = 220 Pa Canadian Air Infiltration/Exfiltration = A3
STANDARD	RATING								
AAMA/WDMA/CSA 101/1.S.2/A440-11	Class LC-PG30 Size Tested 143.5" x 71.5" DP=20/-30								
AAMA/WDMA/CSA 101/1.S.2/A440-08	Class H-LC30 Size Tested 143.5" x 71.5" DP=30/-30								
AAMA/WDMA/CSA 101/1.S.2/A440-08 A440S1-09	Class H-LC30 - 3645mm x 1816mm Positive/Negative Design Pressure (DP) = 1440 Pa/-1440 Pa Water Penetration Resistance Test Pressure = 220 Pa Canadian Air Infiltration/Exfiltration = A3								
FL 15906 Glazing: 2.2mm AN outer/2.2mm AN inner									
<div style="background-color: black; color: white; padding: 5px;"> WARNING This product can expose you to chemicals including titanium dioxide, which is known in the state of California to cause cancer, and methanol, which is known to the state of California to cause birth defects or other reproductive harm. For more information go to www.P65Warnings.ca.gov </div>									
<small>Meets or exceeds CEC & IECC Air Infiltration Requirements of 0.2 CFM/sq.ft. or lower. WDMA Hallmark Certification Program. Complies with HUD UM Bulletin No. 111.</small>									

U-Factor indicates how well a product prevents heat from escaping (the lower the number, the better).

Visible Transmittance refers to how much visible light comes through a product (the closer to 1.0, the more light is transmitted).

WDMA Hallmark Certification verifies the performance ratings of this product were tested by a third-party testing laboratory.

Test Standards

Energy Rating (ER) represents "Energy Rating" and is a rating used in Canada for product comparison purposes (the higher the ER number, the more energy saved during the heating season).

ENERGY STAR® Climate Zone Map is based on U-Factor and solar heat gain coefficient criteria for specific ENERGY STAR climate zones within the United States and Canada. The shading of the map shows which climate zone(s) a particular product and glass type is ENERGY STAR certified in.

Solar Heat Gain Coefficient measures how well a product blocks heat caused by sunlight (the lower the number, the more it will help reduce the use of air conditioning and as a result, reduce electrical bills and energy use).

Performance Grade (PG) and Design Pressure (DP) Ratings

Glass Construction used with this product type.

Combination Designs, Product Performance & Installation

* NFRC ratings are based on modeling by a third-party agency as validated by an independent test lab in compliance with NFRC program and procedural requirements.

INSTALLATION ACCESSORIES

Listed are optional accessories available for the installation of Andersen® windows and doors. You'll also find key considerations regarding the use and installation of every Andersen product on the following pages. Keep the instruction guidelines and safety information in mind when considering the installation and use of any Andersen product. Should you have any questions, contact your local Andersen supplier. Thank you for considering and using Andersen.

ACCESSORY	LENGTH	DEPTH	WIDTH
Fibrex® Trim Board	120" (3048)	3/4" (19)	3 1/2" (89)
Auxiliary Casing	150" (3810)	1 3/16" (30)	1 3/16" (30)
Rigid Vinyl "H" Channel, White	84" (2134) 150" (3810)	3/4" (19)	1" (25)
Rigid Vinyl "H" Channel, Sandtone & Terratone	84" (2134) 150" (3810)	3/4" (19)	3/4" (19)
Rigid Vinyl "h" Channel	150" (3810)	1/2" (13)	1" (25)
Rigid Vinyl "J" Channel	150" (3810)	1/2" (13)	3/4" (19)

CONTINUOUS DRIP CAP

Heavy 24-gauge corrosion-resistant aluminum construction in two profiles to match frames. Available in white, canvas, Sandtone, Terratone, forest green, dark bronze and black. Available in 6' (1829), 10' (3048) and 12'- 7 1/8" (3848) lengths.

FIBREX TRIM BOARD



Available in white, canvas, Sandtone, Terratone, dark bronze, forest green, dove gray, prairie grass, red rock, cocoa bean and black, this solid trim board can be cut or ripped to size and can be fastened using nails or screws.

AUXILIARY CASING

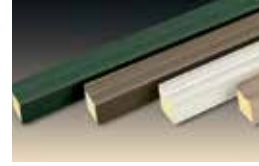

Auxiliary casing is made of cellular Fibrex material. Available in white, canvas, Sandtone, Terratone, forest green, dark bronze and black.

VINYL CHANNELS



Rigid vinyl "J," "h" and "H" channels are available in white, Sandtone and Terratone.

COIL STOCK

Andersen aluminum coil stock (shown below with insert window installation accessories) can be ordered in white, canvas, Sandtone, Terratone, dark bronze, forest green, dove gray, prairie grass, red rock, cocoa bean and black colors. Made from .018" thick Andersen aluminum, coil stock is available in 24" (610) x 50' (15240) rolls. Color-matched 1 1/4" (32) stainless steel trim nails are also available and can be ordered in 1 lb/.454 kg boxes.

COLOR-MATCHED SEALANT

Color-matched sealant is available in Andersen exterior colors. This high-quality sealant can be used during the installation of all Andersen products.

INSTALLATION ACCESSORIES FOR INSERT WINDOWS

EXTERIOR SILL EXTENDER



Sill extender fits into the exterior accessory kerf in the window frame to hide the gap between the new insert window and the existing window frame at the sill. Precut to fit a 14° sill slope, it can be cut to fit other slopes as needed. Available in all exterior colors. Shown in white.

HEAD EXPANDER



Head expander assists in filling the opening at the top of the window when doing an interior installation. Available in white.

COIL STOCK



Coil stock fits into the exterior accessory kerf in the window frame, then wraps the existing wood window trim. Cut and

form the profile at the jobsite. Andersen aluminum coil stock can be ordered in white, canvas, Sandtone, Terratone, dark bronze, forest green, dove gray, prairie grass, red rock, cocoa bean and black colors. Made from .018" thick aluminum, coil stock is available in 24" (610) x 50' (15240) rolls. Color-matched 1 1/4" (32) stainless steel trim nails are also available and can be ordered in 1 lb/.454 kg boxes.



COLOR-MATCHED SEALANT

Color-matched sealant is available in Andersen exterior colors and is specially formulated to adhere to Andersen products.

FOAM BACKER ROD

Available for installations, 3/8" (10) backer rod helps provide an air seal around the frame. Available in 100' (30480) rolls.

SHIMS

Flat self-hanging shims help with a secure installation. Available in boxes of 248 shims.

EXTERIOR FRAME EXTENDERS



Frame extenders fit into the exterior accessory kerf in the frame to hide the gap around the sides and/or head between the new insert window and the existing window frame. Cut to fit width and length needed. Available in all exterior colors. Shown in dark bronze.

Exterior frame and sill extenders are available in long lengths or can be ordered cut to approximate lengths for jobsite convenience.



Window shown with exterior frame and sill extenders in dark bronze.

INSTALLATION INFORMATION

ROUGH OPENINGS

The purpose of a rough opening is to allow for proper spacing between the window or patio door unit and the building structure. The space is required for locating, leveling and squaring the unit during installation and to provide an area for insulation. A rough opening that is incorrectly sized may affect unit operation and may not allow for adequate fastening of the unit to the building structure. Andersen minimum rough opening dimensions are provided as a guideline to help determine the minimum amount of space needed between the window or patio door and the building structure. See appropriate product sections for rough opening guidelines for each product.

Keep in mind that rough opening dimensions may need to be altered from published guidelines, depending on installation methods, joining methods, replacement methods, etc. For example, flashing systems can reduce the amount of available rough opening space and should be factored in when calculating rough opening dimensions. The use of support or joining materials will encroach on the rough opening and may require additional rough opening space between the unit and the building structure, depending on the thickness of the flashing system and joining materials used. To facilitate drainage, the rough opening sill plate should never slope toward the interior. For challenging environments and other information, refer to Energy and Environmental Building Association's (EEBA) Water Management Guide (www.eeba.org).

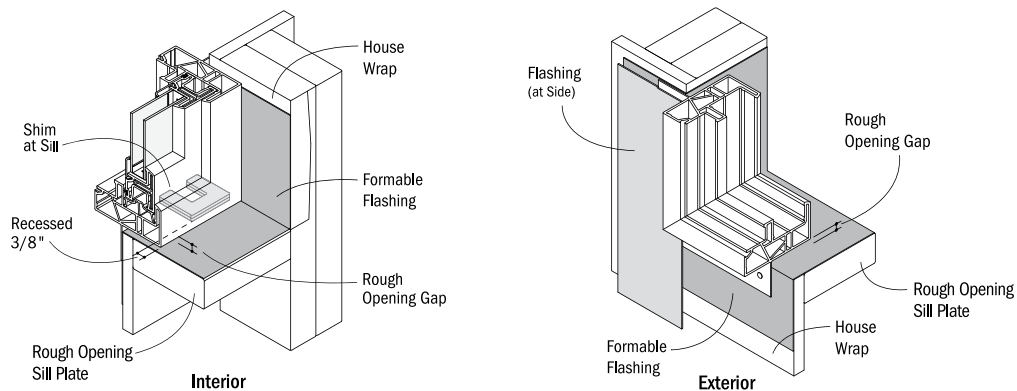

Example of window sill flashing in a membrane drainage system.

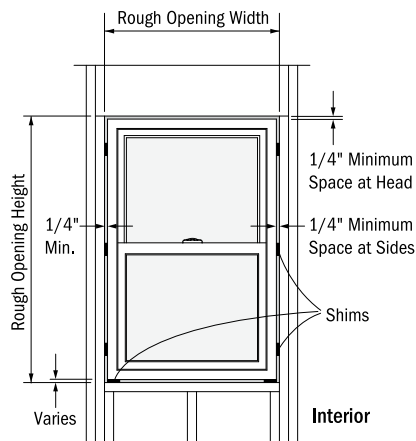

Example of window unit installed using Andersen published minimum rough opening dimensions.

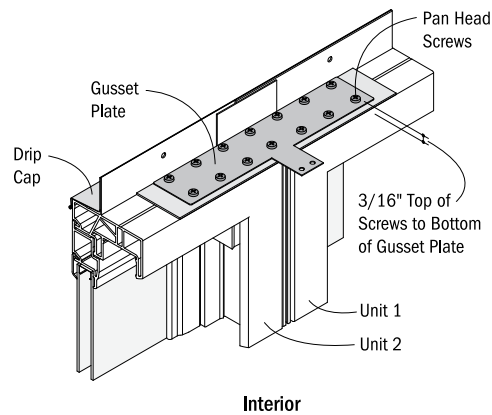

Example of two units joined together with the use of gusset plates and pan head screws that will require additional rough opening space. Rough opening for joined units must be a minimum of 3/4" (19) plus the overall joined window dimensions.

IMPORTANCE OF PROPER INSTALLATION

Proper installation and maintenance of Andersen® products are essential to attain optimum performance and operation. Installation instructions that provide guidelines for proper installation are typically provided with Andersen products. They are also available by visiting andersenwindows.com. Remember that every installation is different, and Andersen strongly recommends consultation with the local supplier or an experienced contractor, architect or structural engineer prior to the installation of any Andersen product. The method of attachment for Andersen products, fastener selection and code compliance are the responsibility of the architect, building owner, contractor, installer and/or consumer. For more complete installation details, visit andersenwindows.com or see your Andersen supplier.

* Dimensions in parentheses are in millimeters.

INSTALLATION INFORMATION

GENERAL NOTES

When ordering, make certain you specify, then verify, the exact product, unit dimensions, configuration requirements, color and options you desire on each window or patio door. Before installing the product, we suggest you verify that it includes the features and options you ordered. Visit andersenwindows.com for product installation and joining guides. Printing limitations prohibit exact color duplication of products. View actual samples for building specifications. Andersen Corporation reserves the right to change details, specifications or sizes without notice. The customer assumes all risk of alterations made to Andersen® products.

CODES

Appropriate selection of Andersen products that conform to all applicable laws, ordinances, building codes and safety requirements is the sole responsibility of the architect, designer, building owner and/or contractor. Check with your local building code officials for specific information. Unit wind load, performance grade and energy performance information is provided on pages 103-107. For up-to-date product performance information, visit andersenwindows.com. The performance of any building system depends on the design and construction of the building system in its entirety, which should meet building code requirements, as well as address product and material limitations and local environment and climate.

DRIP CAPS

Drip caps are a specific type of flashing or trim that is used at the head of a window or door to direct water from the drainage plane out beyond the face of the unit.

FLASHING

Flashing is an important element in a building's water management system. It is used to shed and direct water to the building exterior or to the drainage plane. Flashing materials are typically applied starting from the bottom and working upward, with each successive layer overlapping the previous one in shingle fashion. Water infiltration problems in any type of building can be reduced by properly flashing and/or sealing around all building openings, including windows and doors.

USE OF SHIMS

Shims are often used along the side jambs of windows and doors to center the unit in the rough opening and to position it plumb, level and square. In addition, shims are always required for windows only under the sill at the side jambs to lift it off the rough opening sill plate. Shims also enable a straight frame for proper weatherstrip contact and unit operation. If not placed properly, unit performance and operation can be affected. Use waterproof shims capable of supporting the weight of the product. When using tapered shims, use them in pairs with the tapers opposing each other to avoid tilting the unit or twisting (rotating) of the jambs.

SEALANTS

Sealants are elastic materials used to block the passage of water and/or air while allowing movement between the two sides of the joint. A sealant should bond tightly and be able to expand and contract to accommodate joint movement without cracking or tearing away from the substrate. Surfaces must be clean, dry and sound for adequate sealant adhesion. Choose a sealant that is compatible with, and that will adhere adequately

to, all building materials used in the window and patio door area. Proper sealant joint design is based upon the expected movement of adjacent materials and the movement capability of the sealant. A general rule of thumb is that the depth of the sealant joint should be equal to half the width ($D = W/2$), but generally not less than $1/4"$ (6) or more than $1/2"$ (13). Foam-plastic backer rod can be used to limit the depth of the sealant joint, to provide a backstop for tooling the sealant without damage to the bond. It also acts as a bond breaker to help minimize stress in the sealant. Sealants should be maintained seasonally and repaired and/or replaced as needed.

GENERAL INSTALLATION GUIDELINES

1. Read and follow the installation guide in its entirety.
2. Decide whether you are integrating to a surface barrier or a membrane drainage system before installing the product. The appropriate method for your installation may vary based on building design, application and industry practices.
3. Make certain the drainage plane is continuous (proper overlaps to shed water, taped seams, etc.).
4. Andersen products should be installed only in the vertical position.
5. Check the rough opening to make sure it is sized properly, is square and is level.
6. Install the window plumb.
7. Install the window level.
8. Install the window square. Diagonal measurements should be within $1/8"$ (3).
9. Follow installation instructions to properly locate shims and to make sure that units are plumb, level and square. Shims are always required under the window jambs at the sill and along the jambs on the sides.
10. Check for squareness of unit before final anchoring of the product into the wall.
11. Anchor window as directed with appropriate fasteners.
12. Integrate the window into the drainage plane of the wall using quality flashing and sealing materials. All flashing materials should be properly overlapped to shed water.
13. Allow $1/4"$ (6) minimum space for a sealant joint around perimeter of unit between exterior cladding/siding and unit.
14. Insulate and seal the interior cavity between the window frame and the rough opening.
15. Check unit operation before application of interior trim.

EXTERIOR PAINTING/SEALING OF ANDERSEN PRODUCTS

The exterior of some Andersen products may be painted or stained. However, improper painting and staining may cause damage to vinyl, aluminum and other exterior materials.

CAUTIONS

1. Do not apply any type of film to insulating glass. Thermal stress and glass damage can result. Andersen Corporation is not responsible for product performance when films are applied to Andersen products.
2. The use of removable insulating materials such as insulated window coverings, shutters and other shading devices may also cause thermal stress conditions and/or deformation of protective vinyl. In addition, excessive condensation may result, which can have a deteriorating effect on the window or patio door unit(s) involved. Andersen Corporation is not responsible for product performance when these kinds of

materials or devices are applied to or used in conjunction with Andersen products.

3. In wall construction utilizing brick facades, leave adequate clearance between sill, jambs and brick for sealing and dimensional change of framework.
4. Acid solutions commonly used to wash brick and other masonry materials will damage glass, fasteners, hardware and metal flashing. Protect unit and follow cleaning product instructions carefully. Damage caused by acid solution is not covered under the Andersen limited warranty.
5. Andersen windows may be combined in ribbons or stacks if each unit is positively secured to structural elements on opposing sides and if the proper joining system is used. See page 99-101 for more information.

SAFETY GLASS

Unless specifically ordered, Andersen windows are not made with safety glass and, if broken, the glass could fragment, causing injury. Andersen windows may be ordered with tempered glass which may reduce the likelihood of injury when broken. All Andersen patio doors are made with tempered glass. Differences in appearance between tempered and non-tempered glass can be expected. Slight visual distortions may be noticeable and occur normally as a result of the tempering process. Building codes require safety glass in locations adjacent to or near doors and other locations.

WINDOW AND PATIO DOOR SAFETY

Windows may provide a secondary avenue of escape or rescue in an emergency, such as a fire. Every family should develop an escape plan and make sure family members know how to escape from the home in an emergency. In your plan, include two ways to escape from every room in case one way is blocked by fire or smoke, and make sure you have a designated meeting place outside. A window or a door is an alternate means of escape or rescue. Practice your plan until each member of the family understands it and is able to escape without assistance. Remember, you may not be able to reach children during a fire emergency. Teach children – even very young children – that they must escape from a fire in the home and never hide from the fire or from emergency personnel.

LOOKOUT FOR KIDS® PROGRAM

The Consumer Product Safety Commission has said: "Keep children away from open windows to prevent falls. Don't depend on insect screens to keep the child from falling out of the window. They are designed to keep insects out, not children in. Avoid placing furniture near windows to keep children from climbing to a window seat or sill." In an effort to educate consumers about the potential for child falls from windows, Andersen Corporation created the LookOut For Kids Program. It combines a window and door safety brochure and specific product instructions to help make window and door safety an important priority for consumers. For more information on child safety, write:

Andersen Corporation
LookOut For Kids Program
100 Fourth Avenue North
Bayport, MN 55003
Call: 1-800-313-8889 Email: lofk@andersencorp.com

Look!
OUT!
for kids®

* Dimensions in parentheses are in millimeters.



THE ENVIRONMENT HAS A BUSINESS PARTNER

Respect for the environment is nothing new at Andersen. For more than a century, it's been part of who we are. Our commitment to recycle and reclaim materials began simply because it was good business. Now it's part of our broader commitment to sustainability and responsible stewardship of all our resources. Andersen is committed to providing you with long-lasting,* energy-efficient windows and patio doors. Visit andersenwindows.com/sustainability for more information.



Andersen® products are certified under the National Fenestration Rating Council's voluntary third-party certification program designed to ensure accurate energy performance ratings and labeling.



The Window & Door Manufacturers Association (WDMA) Hallmark Certification program includes product testing and quality-control process audits to verify that Andersen windows and doors are produced in conformance with the industry standards for air, water resistance and structural performance.



Andersen Corporation is proud to be an ENERGY STAR® partner. For over 115 years, Andersen has built a reputation for environmental stewardship and energy-efficient products. In fact, Andersen has been part of the ENERGY STAR program since it started and was the first window manufacturer to be named an ENERGY STAR National Window Partner of the Year in 1999.



Andersen was the first window manufacturer to certify our products for indoor air quality, beginning in 2008. Our Indoor Advantage™ Gold certification by SCS Global Services (SCS) meets the rigorous high standards for healthier indoor air quality set by the California Specification 01350.



Under U.S. Green Building Council (USGBC) guidelines, Andersen is able to claim a percentage of material in its Fibrex® product as pre-consumer recycled content. SCS Global Services (SCS) has certified this amount for Andersen.

* Visit andersenwindows.com/warranty for details. All logos and marks are trademarks of their respective owners.

Andersen® windows and doors can make significant contributions to the success of sustainable design strategies.

As a charter member of the U.S. Green Building Council, we are active supporters of certified green buildings. Our products can help customers in pursuing green building programs, such as Leadership in Energy and Environmental Design (LEED®), the National Green Building Standard, Green Globes, GreenStar and more.

Below is an overview of how our products may assist project teams with pursuing LEED v4 or the NAHB National Green Building Standard rating systems. More detailed credit summaries, as well as information about how Andersen products can support earlier versions of LEED certification (e.g., LEED v3 or LEED 2008), are available at andersenwindows.com.

LEED v4 FOR BUILDING DESIGN AND CONSTRUCTION: NEW CONSTRUCTION AND MAJOR RENOVATIONS

Integrative Process Credit: Energy & Atmosphere

- Minimum energy performance prerequisite
- Optimize energy performance credit
- Renewable energy production credit
- Green power and carbon offsets credit

Materials & Resources

- Construction and demolition waste management planning credit
- Building product disclosure and optimization sourcing of raw materials credit
- Construction and demolition waste management credit

Indoor Environmental Quality

- Minimum indoor air quality performance prerequisite
- Minimum acoustic performance prerequisite – schools
- Enhanced indoor air quality strategies credit
- Low-emitting materials credit
- Thermal comfort credit
- Daylight credit
- Quality views credit
- Acoustic performance credit (option 2)

LEED v4 FOR BUILDING DESIGN AND CONSTRUCTION: HOMES AND MULTI-FAMILY MIDRISES

Energy & Atmosphere

- Minimum energy performance prerequisite
- Education of the homeowner, tenant or building prerequisite
- Annual energy use credit
- Building orientation for passive solar credit
- Air infiltration credit
- Windows credit

Materials & Resources

- Durability management prerequisite
- Environmentally preferable products credit
- Construction waste management credit

Indoor Environmental Quality

- Ventilation prerequisite
- Low-emitting products credit

ANSI ICC/ASHRAE 700-2015 NATIONAL GREEN BUILDING STANDARD

NGBS section numbers are referenced in parentheses.

Resource Efficiency

- Prefinished materials (601.7)
- Flashing (602.12)
- Exterior doors, including storm doors (602.1.10)
- Recycled construction materials (605.3)
- Bio-based products (606.1)
- Wood-based products (606.2)
- Manufacturer's environmental management system concepts (611.1)

Energy Efficiency

- Mandatory requirements (701.1)
- Building thermal envelope air sealing (701.4.3.1)
- Multi-family air leakage alternative (701.4.3.3)
- Fenestration air leakage (701.4.3.4)
- ICC IECC analysis (702.2.1)
- Energy performance analysis (702.2.2)
- UA improvement (703.2.1)
- Fenestration (703.2.5)
- Sun-tempered design (703.7.1)
- Passive cooling design (703.7.3)
- Passive solar heating design (703.7.4)

Indoor Environmental Quality

- Wood materials (901.4)
- Interior architectural coatings (901.9)
- Interior adhesives & sealants (901.10)
- Operable windows & sliding glass doors (902.1.5)

Energy Efficient

- Homeowner's manual (1001.1)
- Building construction manual (1002.1)

91 100 Series Patio Door Overview	88 100 Series Window Custom Sizes	84 100 Series Window Joining Details	66 100 Series Picture, Transom & Specialty Windows	52 100 Series Gliding Windows	30 100 Series Single-Hung Windows	18 100 Series Casement & Awning Windows	15 100 Series Window Overview
			99 Combination Designs, Product Performance & Installation	98 100 Series Patio Door Custom Sizes	97 100 Series Patio Door Joining Details	95 100 Series Patio Door Sidelights & Transoms	93 100 Series Gliding Patio Doors



All trademarks where denoted are marks of their respective owners.
 "Andersen" and all other marks where denoted are trademarks of Andersen Corporation.
 ©2019 Andersen Corporation. All rights reserved. 07/19 Part #9045491

PDF NAVIGATION TIPS

Welcome to an overview of the enhanced navigation tools available in this PDF. Here are some simple tips on PDF navigation. Before you begin be sure you are using the latest version of Adobe Acrobat Reader DC, available at – <https://get.adobe.com/reader/>

To watch a 3-minute tutorial on navigating catalog PDFs, go to: <https://youtu.be/sWWnYn6ON3Y>

BOOKMARK NAVIGATION

①

Acrobat will display the bookmarks panel when you open the PDF.

Bookmarks are the easiest way to find specific product information.

Select a topic and that page will be displayed.

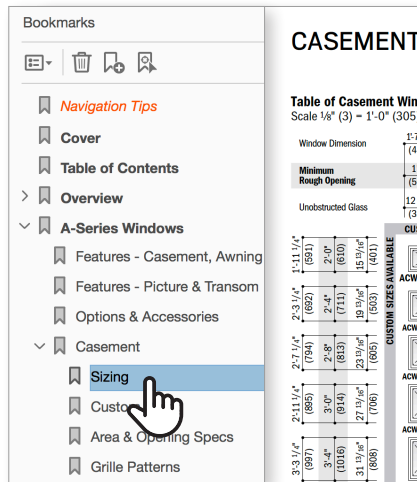

②

If you need to print a specific section, **right click on that section** within in the bookmarks panel and choose “**Print Section.**”

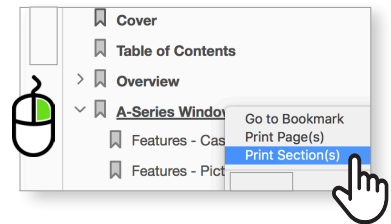

LINKS AND URL NAVIGATION

①

You can also use the **embedded links** to navigate between sections. All links are underlined in blue.

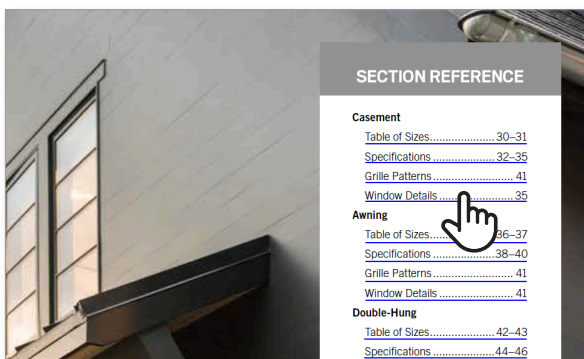

②

Website links automatically open in your web browser.

Beauty in the Details.

The hardware for our A-Series windows is created exclusively for Andersen and is made of forged metal for added strength. A range of available finishes makes it easy for customers to coordinate their window hardware with their cabinet hardware, faucets and other room décor.

Also available with VeriLock® Security Sensors, one of the most advanced technologies in the industry. For more information, see [pages 16-17](#) or visit andersenwindows.com/connect.



The tilt-in feature of A-Series allows one-hand operation



Add additional navigation tools by adjusting the default settings in Acrobat.

TOOL BAR NAVIGATION

1

To add a **“Jump Back” Button** to your tool bar, **right click on tool bar**, select **Show Page Navigation Tools** and choose **Show All Page Navigation Tools**.

Right and left facing arrows are added to the tool bar allowing you to go back or forward to the last page you viewed.

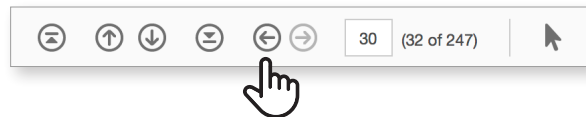
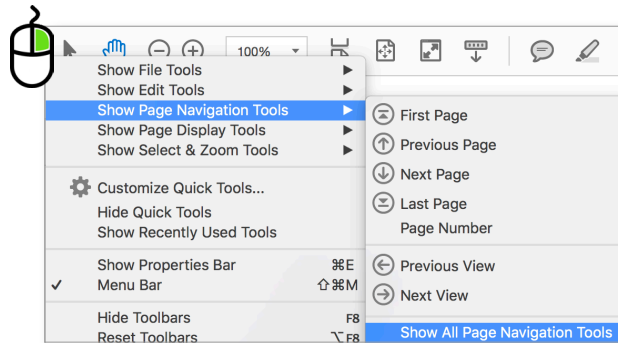

2

Another helpful tool is the **Loupe Tool**. It allows you to zoom in on the page without having to increase the page size.

To add a **Loupe Tool** to your tool bar, **right click on tool bar**, select **Show Select & Zoom Tools** and then choose **Show All Select & Zoom Tools**.

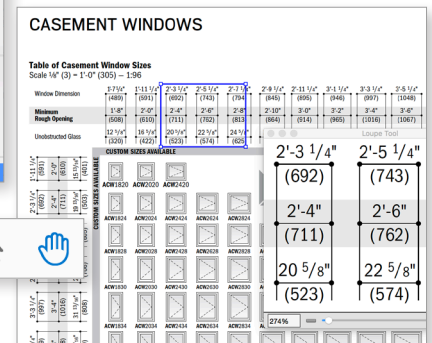
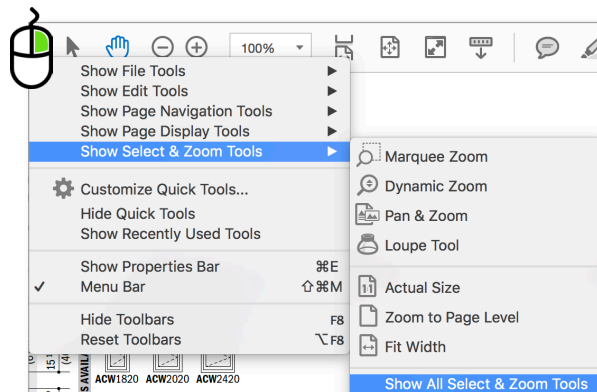

3

You can also use the **commenting tools**. Add a post-it-note with your comments or highlight important information.

Be sure to save the file.

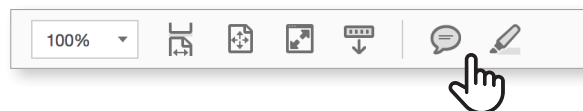

To watch a 3-minute tutorial on navigating catalog PDFs, go to: <https://youtu.be/sWWnYn60N3Y>

We are always looking for ways to improve.
Please send feedback to webmarketing@andersencorp.com.